

ENGLISH

# **STYLE 140, STYLE 180, STYLE 220 pellet stove**

INSTALLATION, USE,  
MAINTENANCE AND HELPFUL  
TIPS



FUOCO E PASSIONE



# CONTENTS

<b>CONTENTS</b> .....	<b>1</b>
<b>INTRODUCTION</b> .....	<b>3</b>
IMPORTANT SAFETY INSTRUCTIONS .....	3
<b>THE MACHINE AND THE PELLETS</b> .....	<b>4</b>
COMPONENTS OF THE APPLIANCE .....	4
OVERALL DIMENSIONS STYLE 140 .....	7
OVERALL DIMENSIONS STYLE 180 / STYLE 220 .....	8
CONNECTIONS DATA SHEET FOR STYLE 140 .....	9
CONNECTIONS DATA SHEET STYLE 180 / STYLE 220 .....	10
TECHNICAL SPECIFICATIONS STYLE 140 .....	11
TECHNICAL SPECIFICATIONS STYLE 180 .....	12
PELLET PROPERTIES .....	13
<b>REQUIREMENTS OF THE PLACE OF INSTALLATION</b> .....	<b>13</b>
POSITIONING .....	13
SPACES AROUND AND ABOVE THE APPLIANCE .....	14
EXTERNAL AIR INTAKE .....	14
THE FLUE AND CONNECTION TO THE SAME .....	15
CHIMNEY .....	16
<b>ELECTRICAL CONNECTION</b> .....	<b>17</b>
CONTROL OF ANY COUPLED BOILER .....	17
CONTROL OF A POSSIBLE THREE-WAY MOTORIZED VALVE FOR DHW SYSTEM MANAGEMENT .....	18
CONNECTION TO THE ROOM THERMOSTAT .....	18
<b>HYDRAULIC CONNECTION</b> .....	<b>19</b>
<b>THE DISPLAY</b> .....	<b>20</b>
<b>THE MENU</b> .....	<b>22</b>
<b>INITIAL START-UP</b> .....	<b>26</b>
SYSTEM CONFIGURATION .....	26
INITIAL FILLING OF THE SYSTEM .....	28
PELLET LOADING AND CONNECTION TO THE MAINS POWER SUPPLY .....	28
IGNITION CYCLE .....	28
SWITCH-OFF CYCLE .....	29
MODIFYING THE WORKING POWER .....	29
CHANGING THE WATER TEMPERATURE BOILER OR PUFFER .....	29
CHANGING THE AIR FAN SPEED .....	30
<b>PROBLEMS, ALARMS, USEFUL TIPS</b> .....	<b>31</b>
USEFUL INFO .....	31
WHAT HAPPENS IF .....	31
ALARM SIGNALS .....	32
<b>CLEANING AND MAINTENANCE</b> .....	<b>33</b>
PRECAUTIONS BEFORE CLEANING .....	33
ROUTINE CLEANING .....	33
NON-ROUTINE CLEANING .....	34
ANNUAL CLEANING .....	36
CLEANING THE CERAMIC GLASS .....	37
CLEANING THE FLUE .....	38

MAINTENANCE .....	38
<b>PCB PARAMETERS .....</b>	<b>39</b>
PARAMETER TABLES STYLE 140.....	39
PARAMETER TABLES STYLE 180.....	41
PARAMETER TABLES STYLE 220.....	43
<b>WIRING DIAGRAM.....</b>	<b>45</b>
<b>STANDARD WARRANTY CONDITIONS.....</b>	<b>46</b>

Dear client,

First of all we would like to thank you for choosing a “KLOVER” product and we hope you will be satisfied with this product.

Carefully read the manual and warranty certificate on the last page of this *User guide*.

In thanking you again for the trust accorded to us, we wish to inform you that these models are the result of forty years of experience in the manufacture of solid fuel products using water as the heat transfer fluid. Every single detail of the product is manufactured by qualified staff, using the most advanced equipment.

The manual contains a detailed description of the appliance and its operation, instructions for proper installation, basic maintenance and control points, which must be periodically performed; furthermore it contains practical advice which helps to obtain maximum performance from the appliance with minimum fuel consumption.

Stay warm with KLOVER!

### **Copyright**

All rights reserved. The reproduction of any part of this manual, in any form, without the explicit written permission of KLOVER Srl is forbidden. The content of this manual may be modified without notice. Although the documentation contained in this manual has been carefully compiled and checked, KLOVER srl cannot be held liable for any damages arising from the use of the same.

Copyright © 2019 KLOVER Srl

## INTRODUCTION

### Important safety instructions

Please read these instructions before installing and using the product.

- The installation and initial start-up of the appliance must be performed by skilled personnel trained in the relevant safety standards. They will be responsible for the definitive installation of the appliance and its proper operation. KLOVER Srl shall not be held liable if these precautions are not observed.
- During the installation and use of the appliance, all local regulations - including those referring to national and European Standards - must be observed.
- Connect the flue gas outlet to a flue with the specifications described in the "Flue and its connection" section of this User guide.
- The appliance is not suitable for installation on a shared flue system.
- If the flue should catch fire, use appropriate fire extinguishing equipment or call the fire brigade.
- Connect the product to an earthed power socket. Avoid using sockets controlled by switches or automatic timers.
- Do not use the power supply cable if damaged or worn.
- If a multiple socket is used, make sure that the total voltage of the connected devices does not exceed the rated voltage for the socket. Also make sure that the total voltage of all the devices connected to the socket does not exceed the maximum permitted level.
- The plug on the appliance's power cable should be connected only once the assembly and installation of the appliance is complete. It should remain accessible after installation if the appliance is not fitted with a suitable and accessible two-pole switch.
- Do not use flammable substances to clean the appliance or its parts.
- Do not leave flammable containers and substances in the place where the appliance is installed.
- The appliance works exclusively with wood pellets and only with the hearth door shut.
- NEVER open the appliance's door during normal operation and avoid using it when the glass is broken or cracked.
- The use of poor-quality pellets or any other material can damage the appliance operation, voiding the warranty and exempting the manufacturer from all liability.
- Do not use the appliance as an incinerator or for any use other than that for which it was designed.
- Do not use fuels other than those recommended.
- Do not use liquid fuels.
- The appliance, and its outer surfaces in particular, become very hot to the touch during operation; handle with caution in order to avoid burns.
- Keep fuel and flammable materials at a safe distance.
- Only use original spare parts recommended by the manufacturer.
- Do not make any unauthorised modifications to the appliance.
- Do not touch the hot components of the product (ceramic glass, flue pipe) during normal operation.
- Never touch the appliance if you are barefoot and/or if you have wet or damp parts of the body.
- Use the appropriate button to switch off the electrical panel. Do not disconnect the power supply cable while the appliance is operating.
- Switch the appliance off in case of a fault or malfunctions.
- During the ignition phase and normal operation of the appliance, maintain the necessary safety distance and do not remain standing in front of it.
- Keep children away from the appliance when it is running since they could get burned by touching its hot components.
- Do not leave the packaging elements within reach of children or unassisted disabled persons.
- Children and inexperienced people must not be allowed to use the appliance.
- The appliance may be used by children no younger than 8 years of age and people with reduced physical, sensory or mental capabilities, or those without experience of the appliance, as long as they are supervised or have received instructions on how to use the appliance safely and understand the hazards inherent to the appliance.
- Children should not play with the appliance.
- User maintenance and cleaning operations should not be carried out by unsupervised children.
- Clean the appliance only when it is cold.
- Clean the brazier whenever the ignition fails and nonetheless at least once a week.
- Do not use the appliance in ways other than those indicated in this user guide.
- The appliance is designed for indoor use only.

- The appliance is designed for heating water and should therefore be connected to a plumbing system (radiators, under-floor heaters, etc.). This system should be suitably designed and sized to distribute the power generated by the appliance.
- This user guide constitutes an integral part of the appliance. If the product is sold to another user, this manual must be passed on to the new owner.

**KLOVER S.R.L. DECLINES ALL LIABILITY IN CASE OF ACCIDENTS DUE TO FAILURE TO COMPLY WITH THE SPECIFICATIONS OF THIS MANUAL.**

**KLOVER S.R.L. DECLINES ALL LIABILITY DUE TO INCORRECT USE OF THE PRODUCT BY THE USER, UNAUTHORISED MODIFICATION AND/OR REPAIRS, AND USE OF NON-ORIGINAL SPARE PARTS OR SPARE PARTS NOT SPECIFICALLY DESIGNED FOR USE ON THIS PRODUCT MODEL.**

**KLOVER S.R.L. SHALL NOT BE HELD LIABLE FOR THE STOVE'S INSTALLATION. THE INSTALLER IS THE SOLE PARTY RESPONSIBLE FOR THIS OPERATION AND IS ALSO ENTRUSTED WITH CHECKING THE FLUE, EXTERNAL AIR VENT AND THE CORRECTNESS OF THE PROPOSED INSTALLATION SOLUTIONS. ALL THE SAFETY REGULATIONS SET OUT IN THE SPECIFIC LAWS IN FORCE IN THE COUNTRY WHERE THE MACHINE IS INSTALLED MUST BE OBSERVED.**

**NON-ROUTINE MAINTENANCE MUST ONLY BE PERFORMED BY AUTHORISED AND QUALIFIED STAFF.**

**To ensure the validity of the warranty, the user must comply with the instructions contained in this guide and, in particular, must:**

- Use the appliance within its operating limits;
- Regularly perform all maintenance activities;
- Authorise expert and competent people to use the appliance.

**Failure to comply with the instructions contained in this guide shall automatically void the warranty.**

## ***THE MACHINE AND THE PELLETS***

### **Components of the appliance**

The table below shows the standard features of the appliance:

Expansion tank	8 l
Safety valve	2.5 bar
Pressure gauge	0 – 4 bar
Check valve	No
Automatic air vent valve	Yes
Heating system pump	Yes. Mod.25/70
Electrical setting for boiler / puffer sensor	Yes
Remote control	Optional
Wi-Fi management module	Optional

The appliance is delivered with the following equipment:

- 1 user, installation and maintenance guide;
- 1 power supply cable;
- 1 cleaning hook for the front heat exchanger;
- 1 conventional warranty certificate.

The images below show certain details of the appliance:

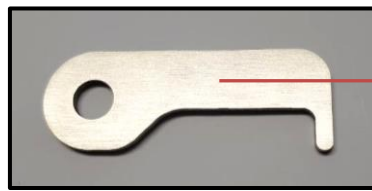

**Hook** for cleaning the front heat exchanger.



**REAR VIEW**

**Opening** for optional connection to safety valve.

**CE label** with technical data, serial number and model.

**Delivery pipe.**

**Return pipe.**

**Safety thermostat** with manual reset.

**Anti-interference filter.** Main switch, connection for power supply cable with 2 built-in fuses (4A 250V).

**R.T. terminal** for room thermostat connection.

**Intake pipe.**

**Flue gas outlet.**

**Terminal** for optional connection to puffer / boiler probe.

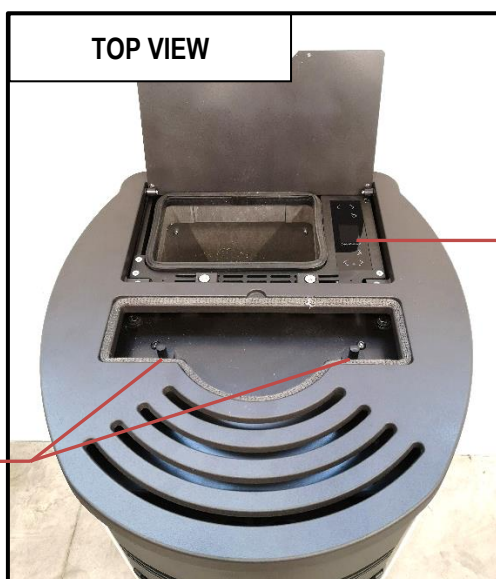

**TOP VIEW**

**Display.**

**Upper knobs** for cleaning internal flue gas turn.

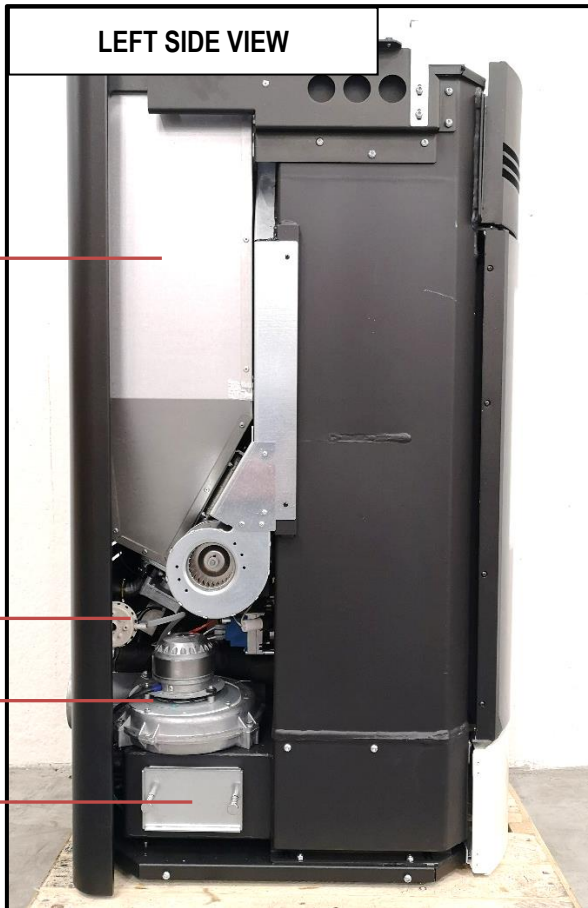

Pellet tank.

Flue pressure switch.

Flue gas intake device.

Overpressure valve.

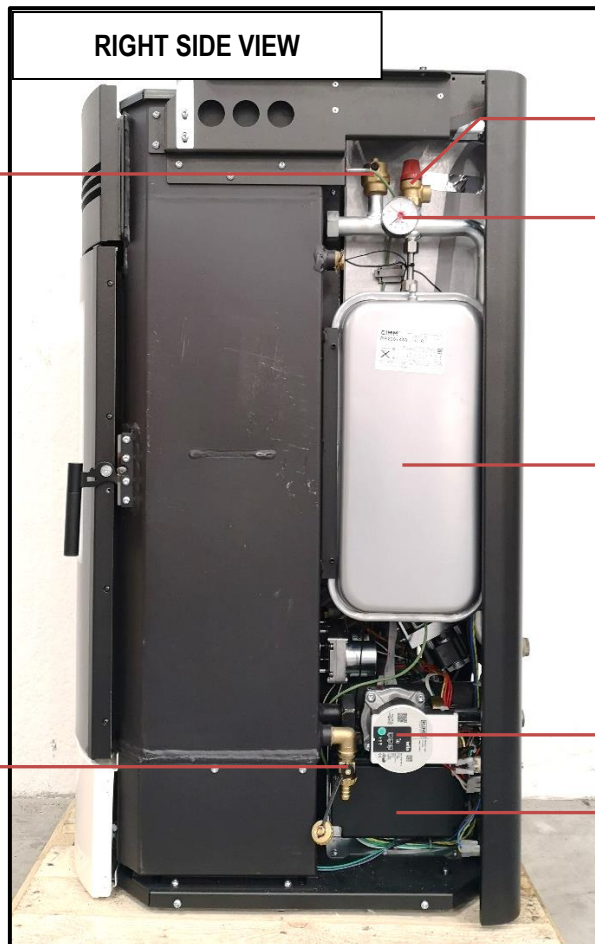

Automatic air vent valve (jolly).

Safety valve (2.5 bar).

Pressure gauge.

Expansion tank 8 l with pre-load 1 bar.

Boiler unit drain cock.

High-efficiency pump with speed selector.

Control unit.



Overall dimensions STYLE 140

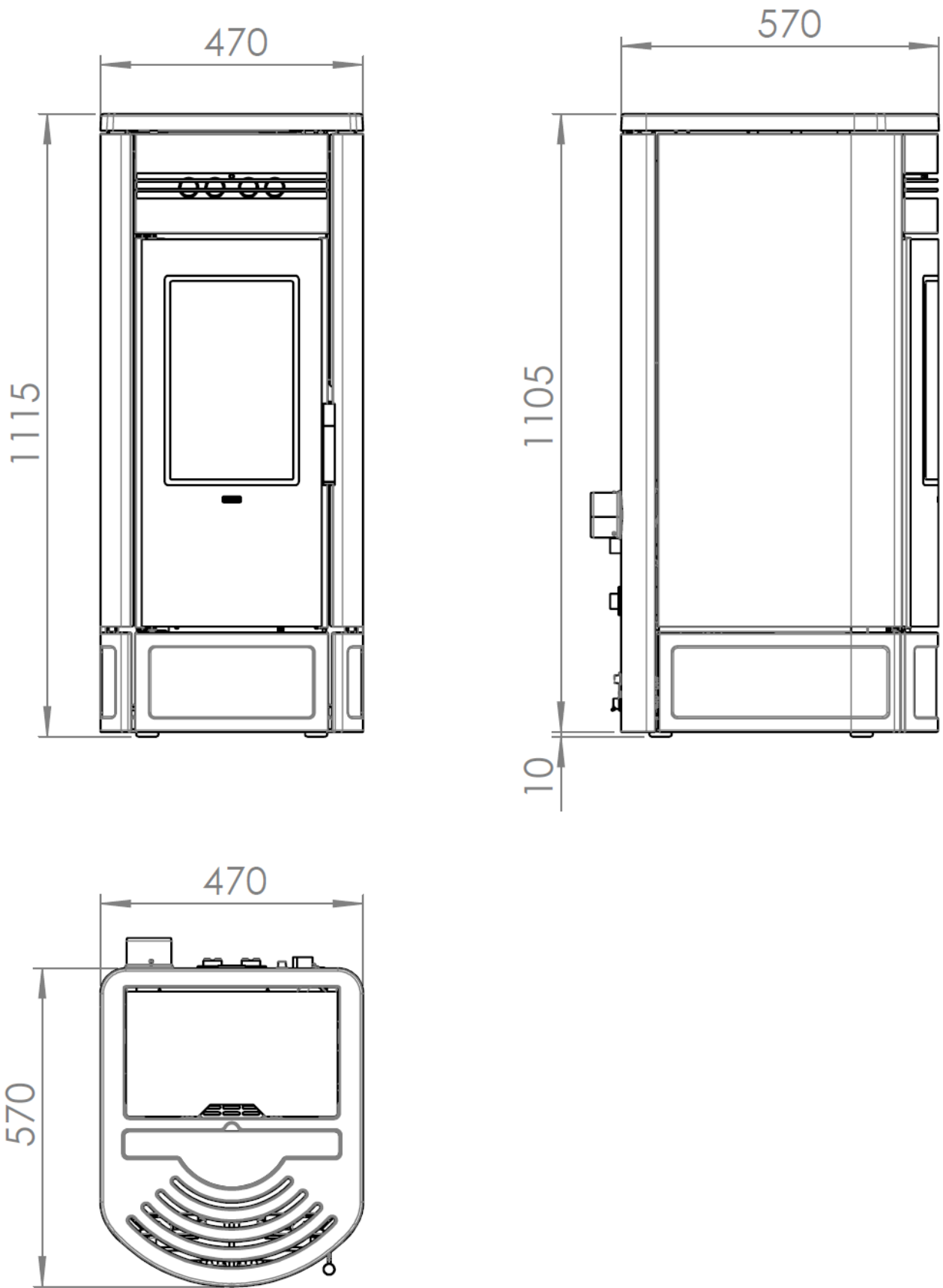

Overall dimensions STYLE 180 / STYLE 220

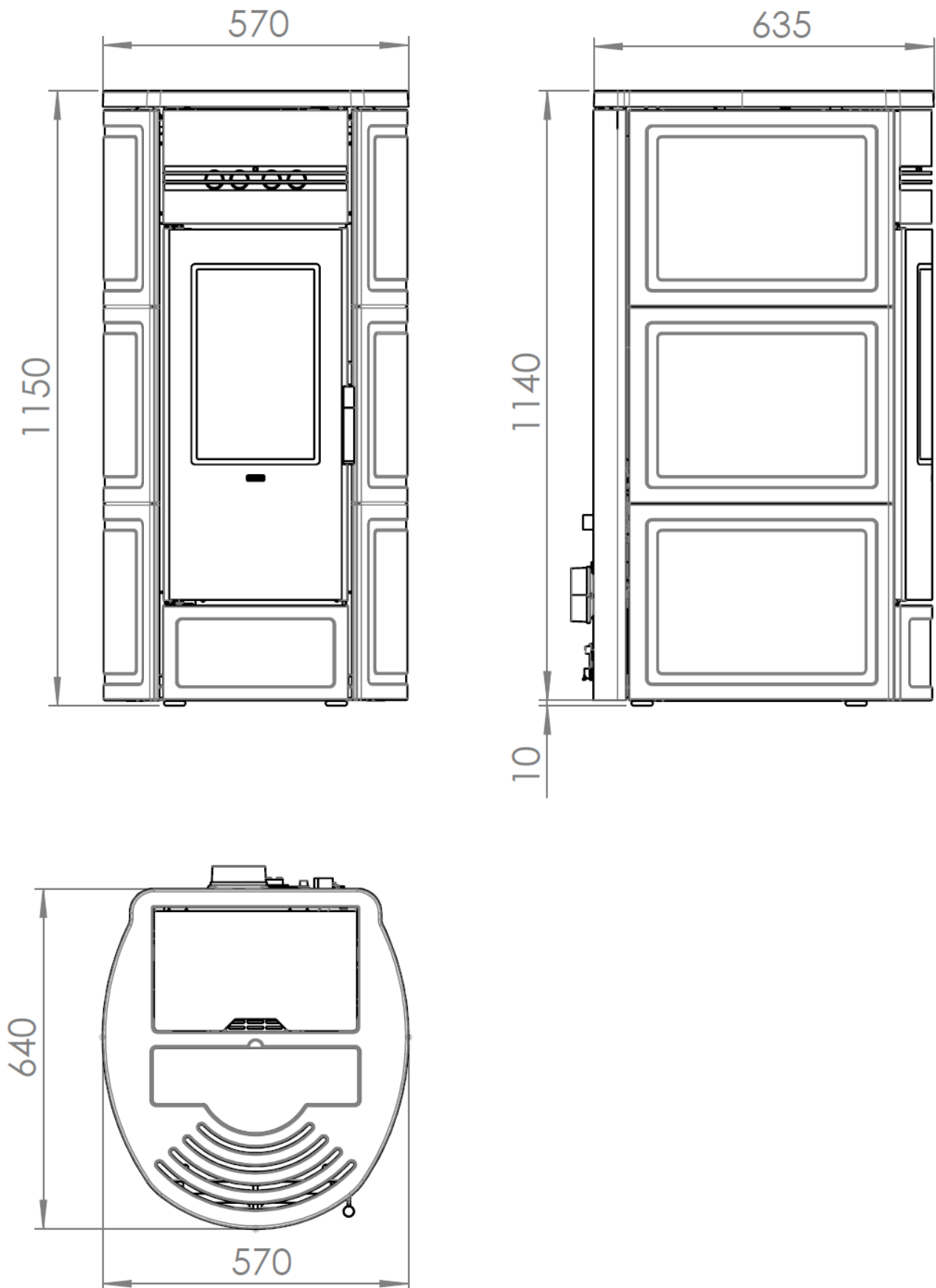

Connections data sheet for STYLE 140

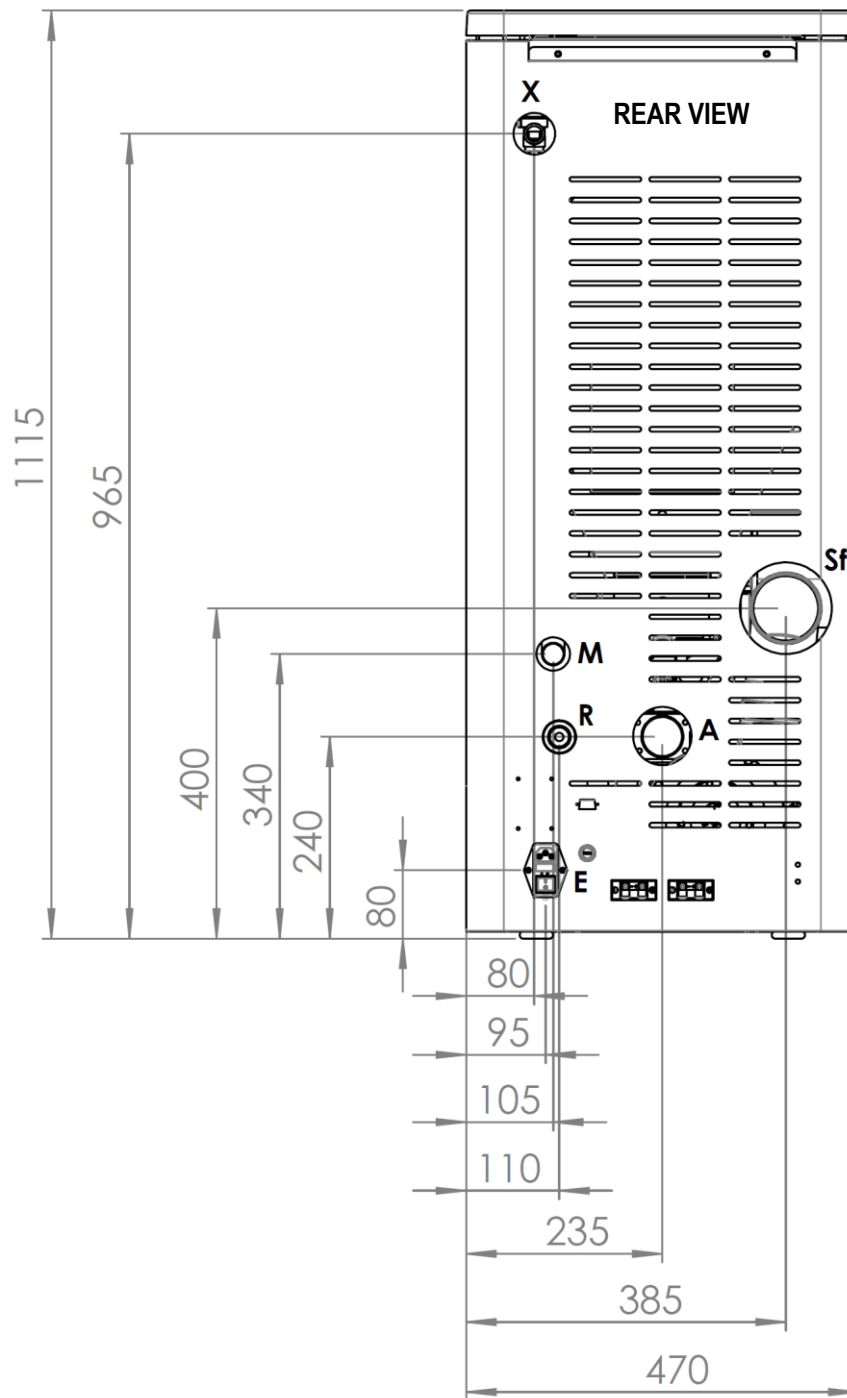

Description of connections

M = System Delivery	3/4" M
R = System Return	3/4" M
X = Safety valve drain	1/2" F
Sf = Rear flue gas outlet	80 mm M
A = Intake pipe	50 mm
E = Electricity connection	

Connections data sheet **STYLE 180 / STYLE 220**

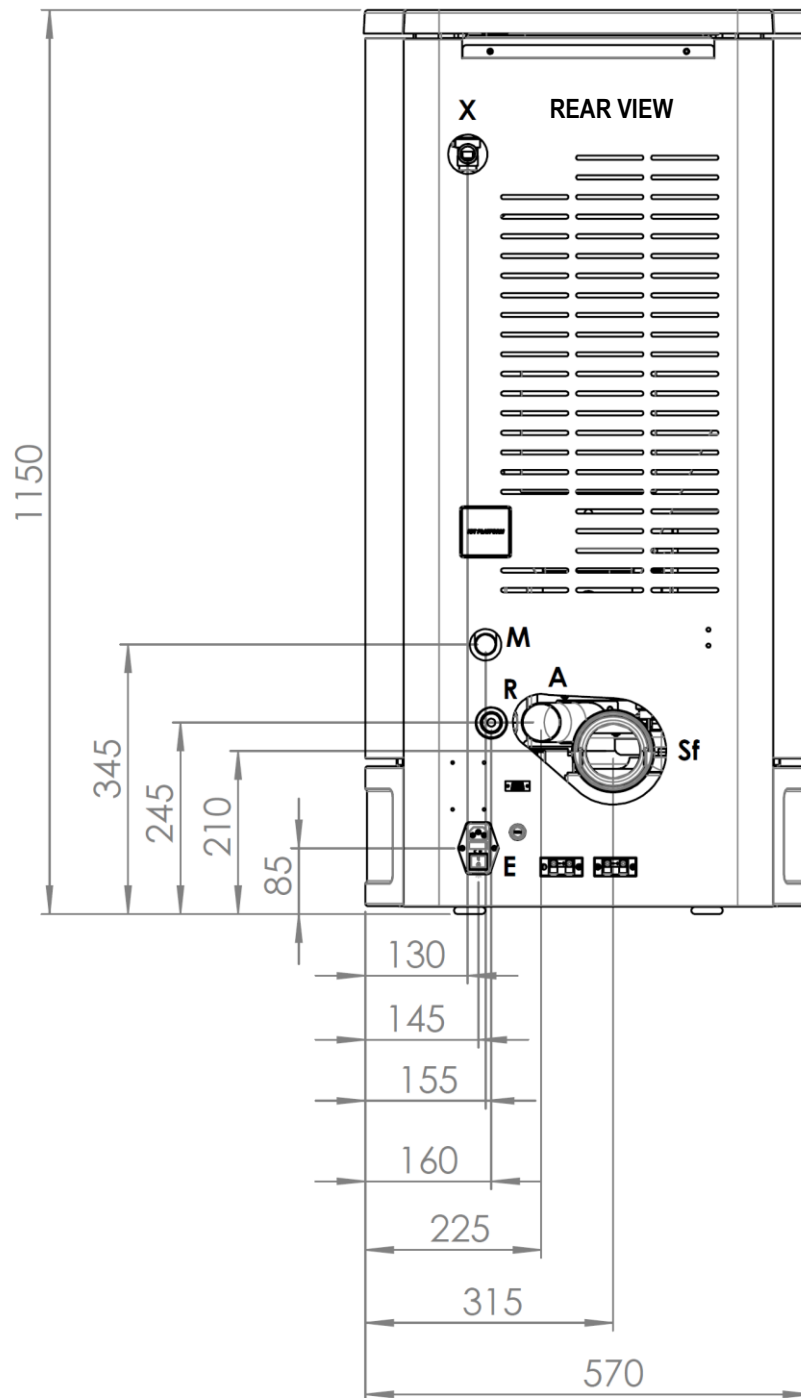

Description of connections

M = System Delivery	3/4" M
R = System Return	3/4" M
X = Safety valve drain	1/2" F
Sf = Rear flue gas outlet	100 mm M
A = Intake pipe	50 mm
E = Electricity connection	

**Technical specifications STYLE 140**

Heat input (nominal setting)	kW (Kcal/h)	<b>17,7 (15.220)</b>
Heat input (reduced setting)	kW (Kcal/h)	<b>5,9 (5.091)</b>
Nominal thermal output	kW (Kcal/h)	<b>17,0 (14.620)</b>
Reduced thermal power	kW (Kcal/h)	<b>5,8 (4.945)</b>
Nominal heat output ceded to water	kW (Kcal/h)	<b>12,8 (11.000)</b>
Nominal heat output ceded to the environment	kW (Kcal/h)	<b>4,2 (3.600)</b>
Reduced heat output ceded to water	kW (Kcal/h)	<b>4,4 (3.784)</b>
Reduced heat output ceded to the environment	kW (Kcal/h)	<b>1,3 (1.118)</b>
Combustion efficiency at nominal thermal power	%	<b>95,8</b>
Combustion efficiency at reduced thermal power	%	<b>97,0</b>
CO at 13% oxygen at nominal thermal power	%	<b>0,003</b>
CO at 13% oxygen at reduced thermal power	%	<b>0,013</b>
Maximum power uptake	Watt	<b>400*</b>
Power uptake during operation at nominal thermal power	Watt	<b>56</b>
Power uptake during operation at reduced thermal power	Watt	<b>14</b>
Power uptake in stand-by	Watt	<b>3,0</b>
Nominal voltage	V	<b>230</b>
Nominal frequency	Hz	<b>50</b>
Expansion vessel litres/preloading bar		<b>8 / 1</b>
Maximum operating/recommended pressure	bar	<b>2,5 / 1,5</b>
Flue outlet diameter	mm	<b>80</b>
Air intake pipe diameter	mm	<b>50</b>
Minimum chimney draught at nominal thermal power	Pa	<b>10,1</b>
Minimum chimney draught at reduced power	Pa	<b>9,6</b>
Combustion gas mass at nominal thermal power	g/s	<b>9,7</b>
Combustion gas mass at reduced power	g/s	<b>4,5</b>
Pellet tank capacity	Kg	<b>22</b>
Average exhaust flue gas temperature at nominal thermal power	°C	<b>83,0</b>
Average exhaust flue gas temperature at reduced power	°C	<b>55,0</b>
Boiler unit capacity	litres	<b>20</b>
Width	mm	<b>470</b>
Height	mm	<b>1115</b>
Depth	mm	<b>570</b>
Minimum safety distance from flammable materials (side / rear / upper / front)	mm	<b>200 / 200 / 750 / 800</b>
Weight	Kg	<b>185</b>

\* Power consumption only during the ignition cycle.

The appliance's heat output may vary depending on the type of pellets used.

**Technical specifications STYLE 180**

Heat input (nominal setting)	kW (Kcal/h)	<b>23.4 (20,120)</b>
Heat input (reduced setting)	kW (Kcal/h)	<b>7.4 (6,370)</b>
Nominal thermal output	kW (Kcal/h)	<b>22.3 (19,170)</b>
Reduced thermal power	kW (Kcal/h)	<b>7.2 (6,190)</b>
Nominal heat output ceded to water	kW (Kcal/h)	<b>17.1 (14,700)</b>
Nominal heat output ceded to the environment	kW (Kcal/h)	<b>5.2 (4,470)</b>
Reduced heat output ceded to water	kW (Kcal/h)	<b>5.4 (4,640)</b>
Reduced heat output ceded to the environment	kW (Kcal/h)	<b>1.8 (1,540)</b>
Combustion efficiency at nominal thermal power	%	<b>95.5</b>
Combustion efficiency at reduced thermal power	%	<b>96.6</b>
CO at 13% oxygen at nominal thermal power	%	<b>0.016</b>
CO at 13% oxygen at reduced thermal power	%	<b>0.045</b>
Maximum power uptake	Watt	<b>400*</b>
Power uptake during operation at nominal thermal power	Watt	<b>56</b>
Power uptake during operation at reduced thermal power	Watt	<b>14</b>
Power uptake in stand-by	Watt	<b>3.0</b>
Nominal voltage	V	<b>230</b>
Nominal frequency	Hz	<b>50</b>
Expansion vessel litres/preloading bar		<b>8 / 1</b>
Maximum operating/recommended pressure	bar	<b>2.5 / 1.5</b>
Flue outlet diameter	mm	<b>100</b>
Air intake pipe diameter	mm	<b>50</b>
Minimum chimney draught at nominal thermal power	Pa	<b>9.2</b>
Minimum chimney draught at reduced power	Pa	<b>9.0</b>
Combustion gas mass at nominal thermal power	g/s	<b>12.8</b>
Combustion gas mass at reduced power	g/s	<b>6.4</b>
Pellet tank capacity	Kg	<b>24</b>
Average exhaust flue gas temperature at nominal thermal power	°C	<b>91.1</b>
Average exhaust flue gas temperature at reduced power	°C	<b>57.8</b>
Boiler unit capacity	litres	<b>30</b>
Width	mm	<b>570</b>
Height	mm	<b>1150</b>
Depth	mm	<b>640</b>
Minimum safety distance from flammable materials (side / rear / upper / front)	mm	<b>200 / 200 / 750 / 800</b>
Weight	Kg	<b>195</b>

\* Power consumption only during the ignition cycle.

The appliance's heat output may vary depending on the type of pellets used.

## Pellet properties

The appliance has been tested with all types of pellets available on the market. The pellets must have the following properties:

- Diameter 6 mm.
- Maximum length 35 mm.
- Maximum humidity content 8 – 9 %.
- 100% wood. Totally additive-free.
- Maximum ash residue 1.1 %.

To obtain good performance from the appliance, we recommend using good quality pellets. **Pellets should be poured into the tank using a shovel, and not directly from the bag.**

Good quality pellets should have the following properties:

- Constant diameter cylinders with a smooth, shiny surface;
- There should not be a lot of sawdust inside the packaging;
- After grabbing a bunch of pellets and placing them into a container filled with water, good-quality pellets will sink and poor-quality ones will tend to float;
- The quality certification data, in particular conformity to international standards such as EN14961-2, DIN 51731 and O-NORM M7135, should be indicated on the packaging;
- The packages should be intact since pellets tend to absorb humidity. Humidity not only reduces the calorific value and increases the amount of flue gases expelled, but also causes swelling of the product which may create problems with the appliance.

The production of pellets must be compliant with some international standards (such as EN14961-2, DIN 51731 and O-NORM M7135) which establish minimum values for quality checks on pellets. To facilitate the right choice of the combustible material you can find below one of the most common certification marks identifying the quality of the pellets:

**Indication of the standard,**  
base reference for the quality  
classes ENplus

**Indication of the quality  
class of the certified pellet**  
(preferable A1)



**IT xxx**

**Code of the certified company**  
consisting of two elements:

- Symbol of the country of production (example "IT")
- Progressive number assigned at the acquisition of the certification (example "xxx")

**The use of poor-quality pellets or any other material can damage the appliance operation, voiding the warranty and exempting the manufacturer from all liability.**

**In order to guarantee trouble-free combustion, the pellets must be stored in a dry place.**

## REQUIREMENTS OF THE PLACE OF INSTALLATION

### Positioning

The initial phase for best installation of the appliance is to determine its optimum location; the following elements need to be considered:

- The possibility of creating an external air vent;
- The possibility of creating a straight flue, preferably coaxial to the outlet of the appliance;
- Proximity to the main water drain and/or the boiler (if one already exists);
- Proximity or ease of connection to the water system;
- Ease of access for cleaning the appliance, the flue gas exhaust pipes and the flue.

The unit must be installed on a floor with a suitable load capacity. If the existing building does not fulfil this requirement appropriate measures (e.g. load distribution plate) must be taken.

**The minimum safety distance from flammable materials must be at least 200 mm from the sides and back of the appliance, 800 mm from the front and 750 mm from the upper part.**

The installation must guarantee easy access for cleaning the appliance, the flue gas exhaust pipes and the flue, and any subsequent maintenance operation by the Authorised technical assistance centre.

Once you have found the best location for the appliance, position it following the instructions given below.

The appliance must not be installed in small rooms, bedrooms, bathrooms or in areas with an explosive atmosphere (e.g. garages).

### Spaces around and above the appliance

The figure below shows the minimum distances from walls or other not-easily-removable furniture, that need to be taken into consideration when positioning the appliance.

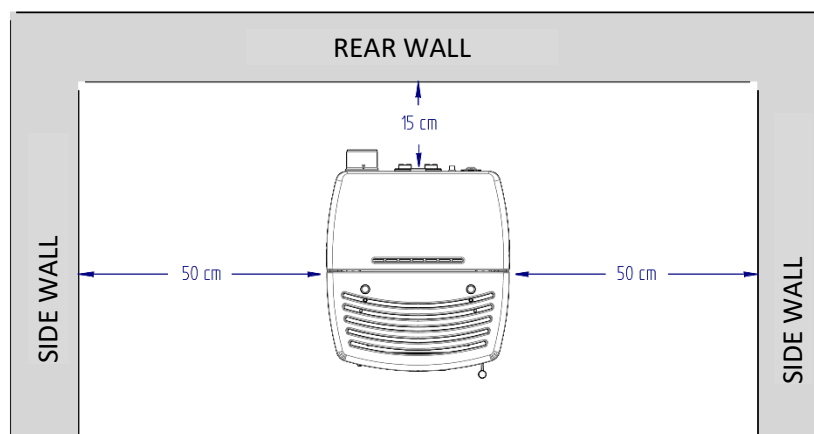

Any shelves or false ceilings mounted above the appliance must be at least 75 cm away from the top part of it.

Furniture and movable objects made from flammable materials must be positioned at least 20 cm from the side surfaces of the appliance; these objects must be moved when performing maintenance on the appliance.

Protect all structures that can catch fire against the radiated heat of the fire.

**Any extra intervention by the Authorised technical assistance centre, which requires the appliance to be disconnected from the system, will not be covered under warranty as described in the chapter “Standard Warranty Conditions”.**

### External air intake

During operation, the appliance takes in air from the environment in which it is installed; It is therefore essential that this air is replaced through an external air vent. The absence of the air vent may affect the flue draught and therefore the combustion and the safety of the appliance.

Therefore **it is mandatory** to install an external air vent with a minimum completely free passage of **at least 80 cm<sup>2</sup>** (round hole with minimum diameter of 15 cm protected with a special fixed large mesh grille).

If it not possible to put the external air vent in the same room as where the appliance is installed, this hole can be made in an adjoining room as long as this room communicates permanently, by means of a transit hole (15 cm minimum diameter).

The hole must be protected externally with a fixed grille. The protective grille must be checked periodically to ensure that it is not obstructed, thereby impeding the passage of air. **Therefore keep the air vents clear of obstructions.**

The UNI 10683 Standard FORBIDS the drawing of combustion air from garages, warehouses storing combustible materials, or from business premises with a fire hazard.



If there are other heating or extraction devices inside the room, the air vents must guarantee a sufficient amount of air for properly operating all the devices.

Only sealed appliances (e.g. C type gas appliances, according to the UNI 7129 Standard) or appliances that do not cause a lower pressure compared with the external environment can pre-exist or be installed in the place where the appliance is installed.

Extractor fans can cause malfunctions to the appliance if used in the same room.

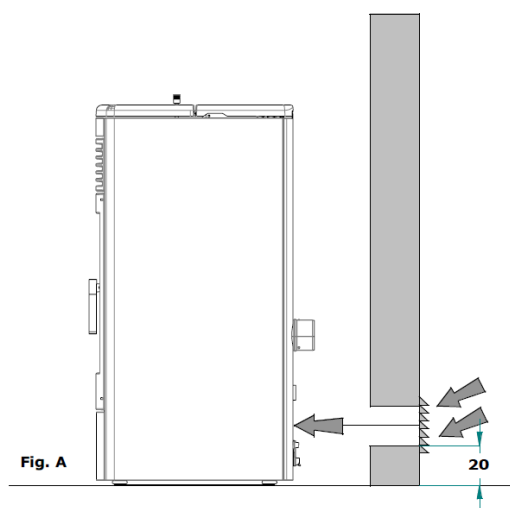

### The flue and connection to the same

The flue is an essential element for the efficient operation of the appliance. The flue must have the minimum cross-sectional dimensions stated in the appliance's technical specifications (SL140 80 mm, SL180 / SL220 100 mm). Each product must be equipped with its own flue, without other adjoining elements (boilers, chimneys, stoves, etc.). The flue dimensions are closely related to its height, which must be measured from the appliance flue gas outlet to the base of the stack. In order to guarantee adequate draught, the surface of the chimney flue outlet must be double the flue cross-section. The discharge pipe for combustion products generated by the forced draught device, must comply with the following requirements:

- It must seal off the combustion gases, as well as being waterproof and suitably isolated and insulated in relation to the conditions of use (refer to UNI 9615);
- It must be made of suitable materials capable of withstanding normal mechanical stress, heat, and the effects of combustion gases and condensate, if any;
- It must go upwards after the vertical section, for the entire remaining part, with a minimum gradient of 5%. The sub-horizontal section must not have a length greater than  $\frac{1}{4}$  of the effective height H of the flue or chimney, and **must not be longer than 2,000 mm**;
- It must preferably have a round internal cross-section: square or rectangular cross-sections must have rounded corners with radius not inferior to 20 mm;
- It must have a constant, free and independent internal cross section;
- Rectangular cross-sections must have a maximum ratio of 1.5 between the sides;
- **It must be insulated** to prevent the fumes from cooling and forming condensation;
- Parts made from non-combustible materials (**it is absolutely prohibited the use of aluminium flue**) - capable of withstanding combustion gases and potential condensation - must be used for mounting the flue gas pipes (for the section from the appliance to the flue inlet);
- It is forbidden to use fibre cement pipes to connect the appliance to the flue;
- Flue gas conduits must not pass through rooms in which the installation of combustion devices is prohibited;
- The flue gas conduits must be assembled in such a way as to guarantee adequate sealing of flue gases during low pressure operation of the appliance;
- **The installation of horizontal sections is prohibited;**
- **It is prohibited to use counter sloping elements;**
- The flue gas pipe must allow for the recovery of soot or be cleanable, and must have a constant cross-section;

- It is forbidden to allow other air intake conduits and system pipes to transit inside the flue gas pipes, even if they are over-sized.

#### **FURTHER SPECIFICATIONS TO BE CONSIDERED**

- The appliance works with the combustion chamber in depression and the flue pipe in pressure; **it is essential that the flue gas outlet is hermetically sealed.**
- The flue pipes inside the installation room must be made of a suitable material (see applicable regulations) and equipped with sealing gaskets with a minimum diameter of 80 mm.
- **The pipes must have a double wall (thermally insulated) or be suitably insulated with rock wool. The maximum temperature of the flue pipe inside the room must not exceed 70°C.**
- **IT IS MANDATORY TO HAVE AN INITIAL VERTICAL SECTION OF AT LEAST 0.5 M IN ORDER TO GUARANTEE CORRECT FLUE GAS DISCHARGE.**
- Every direction change must be carried out with a T-shaped fitting and inspection cap. The tubes must be smoketight thanks to special seals capable of withstanding temperatures of up to 250°C. Attach the pipes to the wall with special collars to prevent any vibration.
- **IT IS STRICTLY FORBIDDEN TO INSTALL DRAUGHT REGULATION VALVES (BUTTERFLY VALVES).**

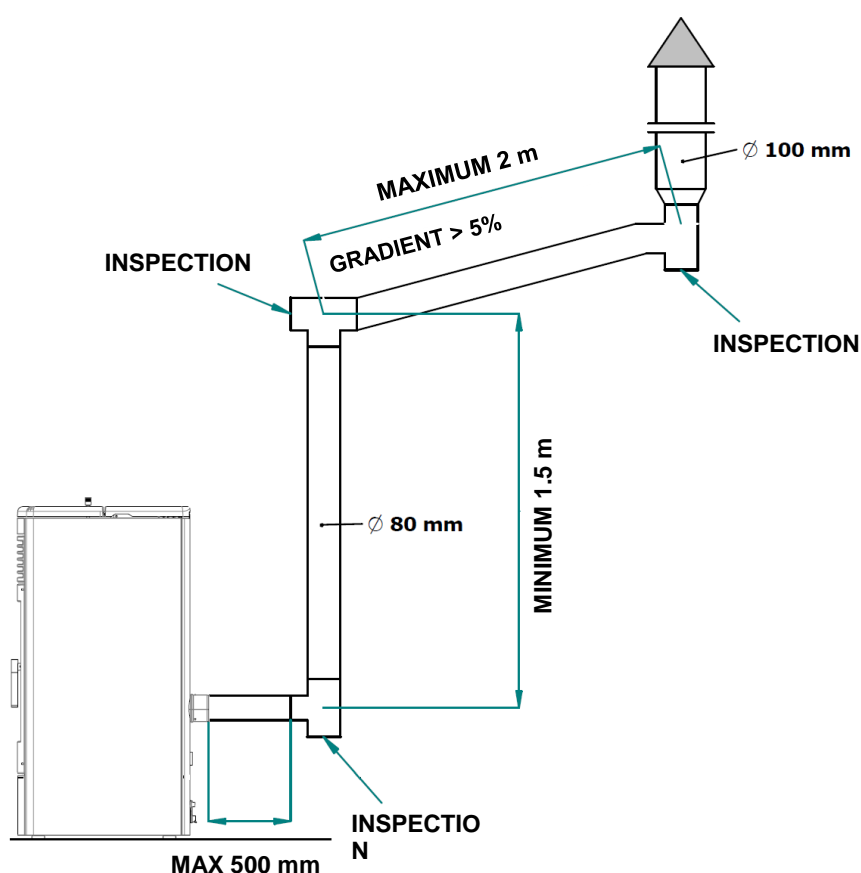

If the flue is old or too large (internal diameter greater than 15 cm), it must be ducted using a stainless steel pipe that is suitably insulated (with rock wool or vermiculite) and sized according to the route. The connection to the flue must be appropriately sealed.

**When assembling the flue, there must be no more than 4 direction changes.**

#### **Chimney**

The **chimney** is a device crowning the flue, used to ease dispersion of combustion products.

It must satisfy the following requirements:

- It must have a usable outlet cross-section no less than double that of the flue onto which it is inserted;
- It must be shaped in such a way as to prevent rainwater or snow from entering the flue;
- It must be built in such a way as to ensure the discharge of combustion by-products even in the event of winds from every direction and inclination.

The outlet height (where height refers to the top of the flue, regardless of any chimney stacks) must be outside of the so-called reflux zone, in order to prevent the formation of counter-pressures preventing the free discharge of combustion by-products into the atmosphere.

It is therefore necessary that the minimum heights - indicated in the following diagrams - are observed:

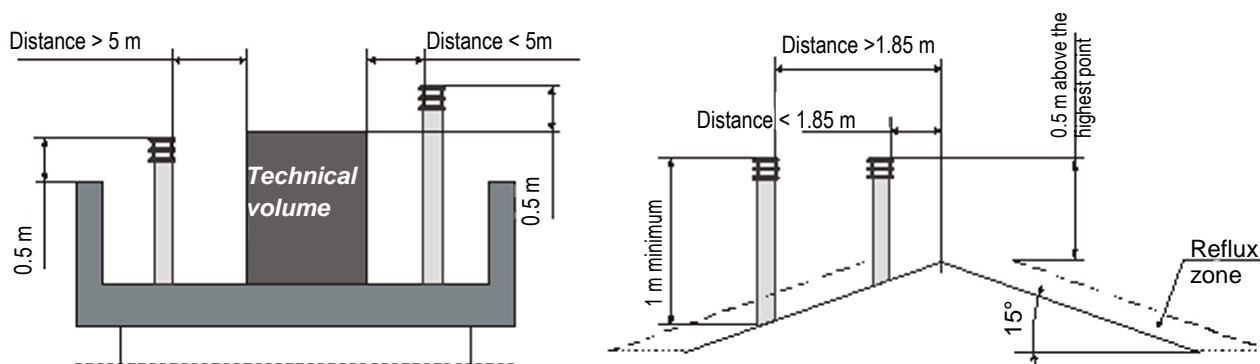

## ELECTRICAL CONNECTION

The electric connection must only be performed by **qualified staff**, in compliance with all general and local safety standards.

**Check that the power supply voltage and frequency correspond to 230V – 50 Hz.**

The appliance's safety is ensured when it is properly connected to an efficient earthing system.

In the electric connection to the mains power supply, include a 6 A – Id 30 mA differential trip-switch with suitable breaking load. The electric connections, including the earth connection, must be made after shutting off the electrical system.

When completing the system, bear in mind that the cables must be laid in an unmovable manner and far from parts subject to high temperatures. During the final wiring of the circuit, only use components with a suitable electrical protection rating. Do not pass electric cables in the immediate vicinity of the flue gas pipe, unless they are insulated with suitable materials.

**KLOVER Srl declines all responsibility for injury to persons and animals or damage to objects due to failure to connect the appliance to earth or to comply with IEC specifications.**

## Control of any coupled boiler

If the pellet appliance is to be coupled with a previously installed boiler in the system (e.g. wall-hung gas boiler), you must ensure that the standard boiler stops when the pellet appliance takes over the heating of the system. The electrical setting, which is accessible from the right-hand inner part of the appliance, intervenes on the standard boiler when the heating circulating pump of the pellet appliance starts up so as to avoid having two boilers operating simultaneously on the same system. The coupled boiler is however always available for the production of domestic hot water.

**The two wires fitted on the left-hand technical compartment of the appliance (blue and brown wires) will have an output voltage of 230 V when the pellet appliance pump is working, and no voltage when the pump stops.**

It is therefore necessary to connect the 2 wires to a relay that will control the Room Thermostat (R.T.) input of the coupled boiler (see the following example).

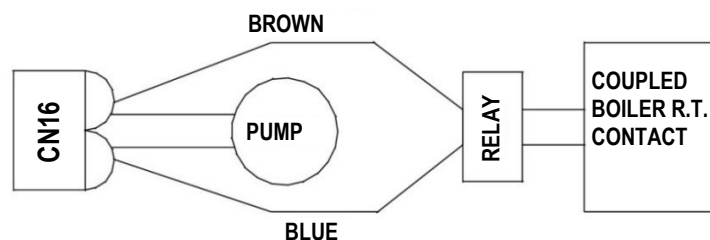

### Control of a possible three-way motorized valve for DHW system management

The pellet appliance is equipped as standard with a control for a possible 3-way motorised valve to be installed on the domestic water circuit based on the selected system type (see [“System configuration”](#)). In the right-hand inner part of the appliance there are four wires with fastons protected by a red seal, which can be used for controlling the valve (see also [“Wiring diagram”](#)). The four wires have different colours, and precisely:

- Blue wire = 3-WAY VALVE COMMON (Neutral 230 V)
- Black wire = SANITARY SIDE (Phase 230 V with DHW demand)
- Black wire = HEATING SIDE (Phase 230 V with no DHW demand)
- Yellow/green wire = GND

### Connection to the room thermostat

Behind the appliance there is a bridged terminal which is used to connect the room thermostat that will command the operation. The operation of the room thermostat is enabled with system types 1, 2 and 3 (see [“System configuration”](#)).

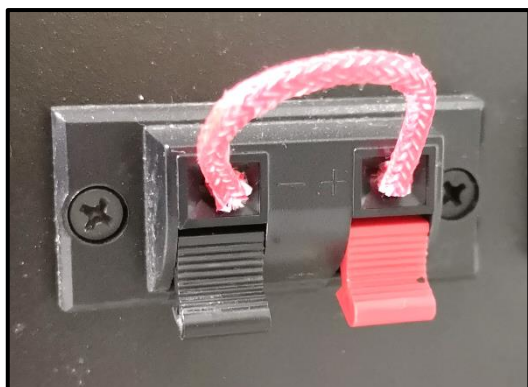

### OPERATING PRINCIPLE

Open contact:

- The appliance switches directly to economy mode operation *“T-AMB ECONOMY”* thus minimising its operating power.
- The heating circulating pump of the appliance switches off.
- The appliance is switched off with a delay of 60 seconds.

The appliance will switch on again automatically if all of the following conditions occur:

- The contact of the room thermostat closes.
- If it goes below the temperature differential (SET H2O – Pr43).  
Once any cooling cycles are complete.

N.B.: If the water temperature exceeds the set threshold of 80°C (safety temperature), the circulating pump of the system is forcedly switched-on to ensure the disposal of excessive heat, thus avoiding high water temperatures in the boiler. For this reason it is recommended that the heating system is not entirely closed.

In the configuration *“System type 3”*, the appliance switches to economy mode and then switches off only if the *“SET BOILER”* temperature setting has been reached.

ATTENTION: In the event that the room sensor in the *“Remote control”* for the appliance is enabled, the appliance switches to economy mode if the *“SET ROOM”* temperature setting has also been reached.

## **HYDRAULIC CONNECTION**

The plumbing connections must be made in a rational way using the connections on the template of the appliance. The appliance can be coupled with any other boiler already installed on the system. In this case it is essential to fit all the necessary safety devices and shut-off valves based on the system and intended use. It is also necessary to consider all laws and national, regional, provincial and municipal regulations of the country where the appliance is installed.

The appliance can be installed with the expansion vessel closed because it is equipped with a device for stopping fuel loading, a safety manual reset thermostat and an audible alarm, which are activated if the temperature becomes too high.

**You can install the appliance in the same room as another boiler only if this has a sealed chamber; installation must be performed in compliance with the current regulations.**

**When installing the appliance, it is advisable to fit an anti-condensate mixing valve between the delivery and return pipes on the appliance's heating system. The anti-condensate valve must be calibrated to 55°C with a Kv value equal to or greater than 8 m<sup>3</sup>/h.**

**When connecting the appliance to the system, you should provide a zone that is always open (such as bathroom area) to enable the excess heat dissipation of the water in the body of the boiler.**

The maximum mains water pressure **should never exceed 2.5 bar**; recommended operating pressure is 1.5 bar (with the appliance in operation).

In the event of water with hardness exceeding 28 °f, an anti-limescale device must be installed. This must be selected on the basis of the specific properties of the water.

**TO AVOID COMPROMISING THE OPERATION AND LIFE OF THE HEAT PUMP, INSTALLATION OF A FILTER AND A MAGNETIC DIRT SEPARATOR IS RECOMMENDED DOWNSTREAM OF THE RETURN PIPE ON THE APPLIANCE.**

The appliance must be mounted **exclusively** by qualified personnel. Scrupulously comply with the instructions given in this guide.

**The manufacturer declines any liability for damages caused due to incorrect assembly.**

### THE DISPLAY

The appliance's operating mode is displayed on the console. After turning on the menu, it is possible to choose from many types of display and available settings according to the selected menu.

The figures below show the display when the appliance is in ON mode.

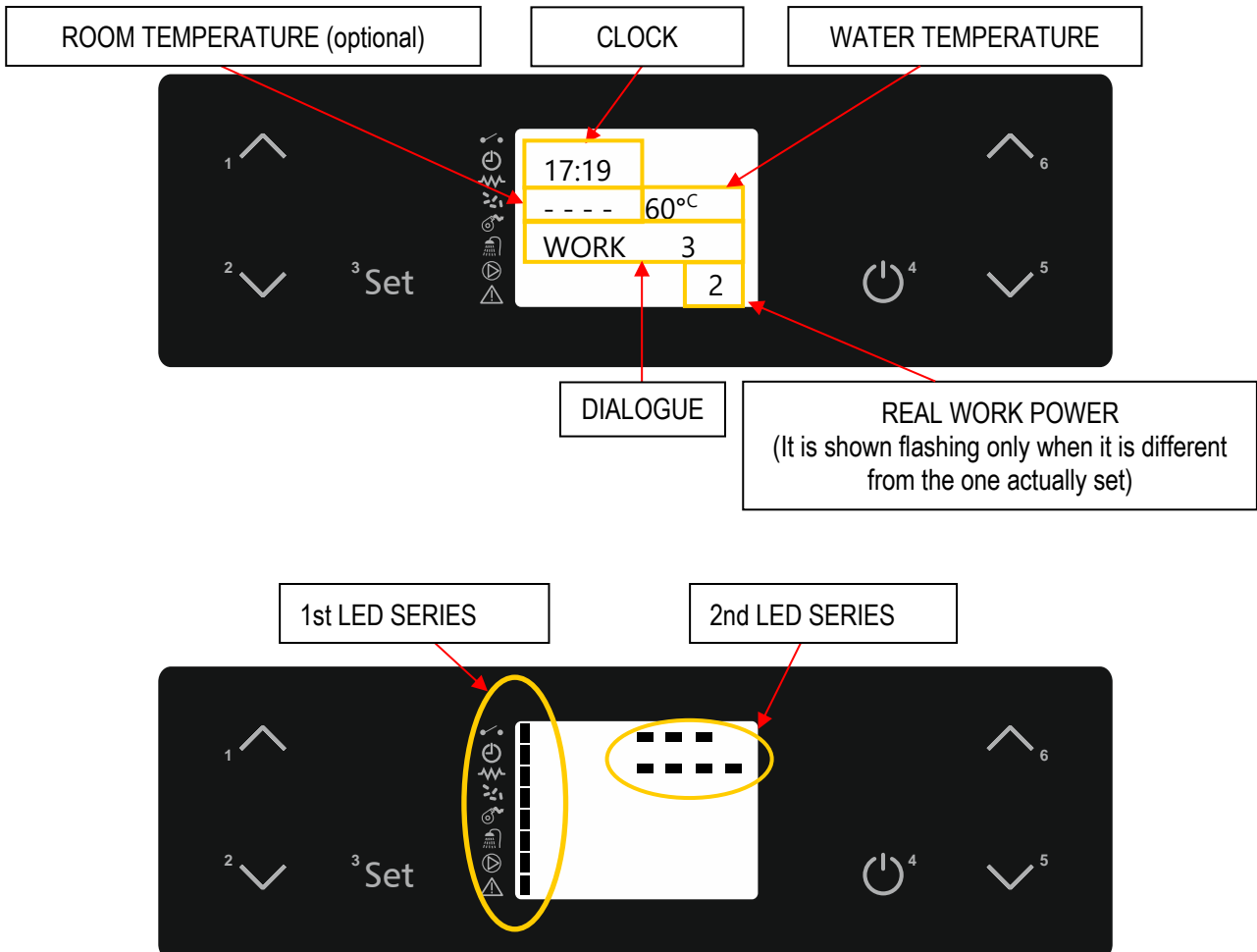

The following figure describes the meanings of the status signals appearing on the left side of the display (1st LED SERIES).

	ROOM THERMOSTAT: the LED is on when the thermostat contact is open.
	PROGRAMMABLE THERMOSTAT: the LED lights up when at least one start-up and switch-off program is active.
	IGNITION PLUG: the LED is on when the ignition plug is active.
	SCREW FEED: the LED lights up when the pellet loading gear motor is started.
	FLUE GAS EXTRACTOR: the LED lights up when the flue gas extractor is active.
	DHW DEMAND: the LED lights up when the DHW flow switch contact is closed (which means there is demand for hot water) or the DHW cylinder or puffer (where fitted) is in demand.
	PUMP: the LED lights up when the system circulation pump is active.
	ALARM: the LED lights up when the boiler is in a state of alarm.

The meanings of the status signals appearing on the top right side of the display are described below (2nd LED SERIES).

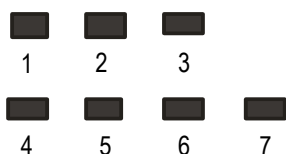

- LED 1: the LED lights up when the daily programme of the on off settings is active.
- LED 2: the LED lights up when the weekly programme of the on off settings is active.
- LED 3: the LED lights up when the weekend programme of the on off settings is active.
- LED 4: the LED lights up (flashing) when the operation parameters are being edited.
- LED 5: the LED lights up when the summer function is active.
- LED 6: the LED lights up when the winter function is active.
- LED 7: the LED is not currently used.

The following diagram shows the display when setting or programming operating parameters.

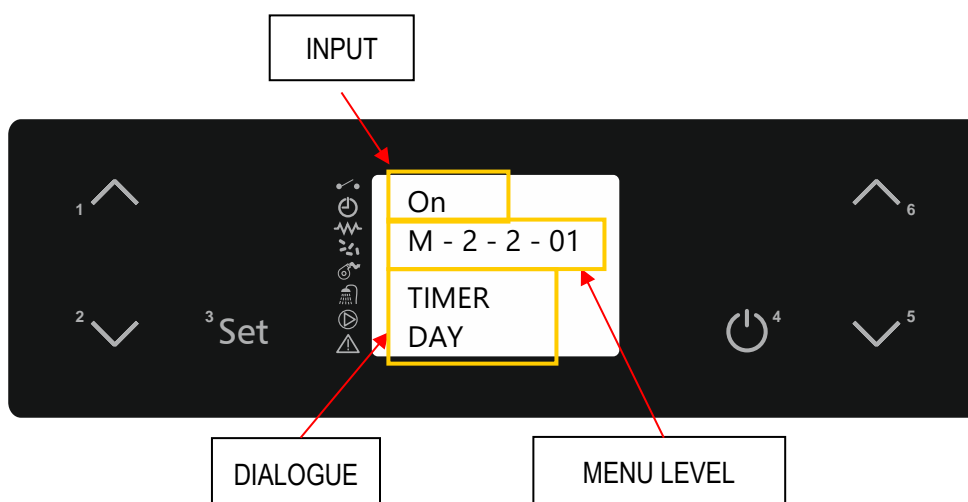

The INPUT area shows the entered programming values.  
 The MENU LEVEL area shows the current parameter/menu level.  
 The DIALOGUE area displays the meaning of the current parameter/menu.

The table explains how the buttons on the display work.

KEY	DESCRIPTION	MODE	ACTION
1	Increase temperature (1)	Programming mode..	Changes/increases the value of the selected menu item.
		Working/off..	It increases the temperature of the room/water thermostat.
2	Decrease temperature (2)	Programming mode..	Changes/decreases the value of the selected menu item.
		Working/off..	It decreases the temperature of the room/water thermostat.
3	Set	-	Enters the menu in question.
		Menu mode..	Accesses the next level of sub-menus.

4	ON/OFF Outlet	Working..	Switches the appliance on and/or off when pressed for 2 seconds.
		In alarm block..	Releases the alarm.
		Menu/programming mode..	Moves you to the previous menu level, saving the changes made.
5	Decrease power (3)	Working/off..	Decreases the working/fan power of the appliance.
		Menu mode..	Moves you to the next menu item.
		Programming mode..	Moves you to the next submenu item, storing the changes made.
6	Increase power (4)	Working/off..	Increases the working/fan power of the appliance.
		Menu mode..	Moves you to the previous menu item.
		Programming mode..	Moves you to the previous submenu item, storing the changes made.

(1) The first press selects "Set temperature for boiler water - SET H2O" or "Set DHW boiler temperature - SET BOILER" or "Set centralised puffer temperature - SET PUFFER" based on the system configuration type.

(2) It selects "Set temperature for boiler water - SET H2O" when first pressed.

(3) It selects "Set air ventilation speed - SET AIR" when first pressed.

(4) It selects "Set operating power - SET POWER" when first pressed.

## THE MENU

Access the Menu by pressing key 3 (Set).

The menu is divided into different items and levels, providing access to the programming and settings options of the appliance.

Buttons 5 and 6 allow you to select the menus to be modified.

Buttons 1 and 2 allow you to change the set value in the selected menu.

Listed below are the menus present on the PCB, with the relevant explanations.

### Menu 01 – Choose season

Allows you to set the season for appliance use (SUMMER / WINTER). Can only be used with plumbing system 3 (see "System configuration").

### Menu 02 – Set clock

Allows for setting the current date and time.

### Menu 03 – Set timer

#### Sub-menu 03 – 01 – enable timer

Allows you to globally enable and disable all programmable thermostat functions. For the correct operation it is recommended to enable it ("ON") when at least one on/off programme (daily, weekly or weekend programme) is activated.

MENU LEVEL	SELECTION	MEANING	POSSIBLE VALUES
03 – 01 – 01	ACTIVATE TIMER	Enable/disable set programs	ON – OFF



**Submenu 03 – 02 – daily program**

Allows you to enable, disable and set the programmable thermostat daily programme functions.

Two operating time slots can be set according to the following table, where OFF signals the clock to ignore the command:

MENU LEVEL	SELECTION	MEANING	POSSIBLE VALUES
03 – 02 – 01	CHRONO DAY	Enable/disable the daily programme	ON – OFF
03 – 02 – 02	START 1 DAY	Turn-on time of the first programme	Time – OFF
03 – 02 – 03	STOP 1 DAY	Turn-off time of the first programme	Time – OFF
03 – 02 – 04	START 2 DAY	Turn-on time of the second programme	Time – OFF
03 – 02 – 05	STOP 2 DAY	Turn-off time of the second programme	Time – OFF

**Sub-menu 03 – 03 – weekly program**

Allows you to enable, disable and set the programmable thermostat weekly program functions.

MENU LEVEL	SELECTION	MEANING	POSSIBLE VALUES
03 – 03 – 01	CHRONO WEEKLY	Enable/disable the weekly programme	ON – OFF

The weekly programmer has 4 independent on/off programmes; it is not essential to use all four simultaneously. By setting OFF in the time field, the clock ignores the corresponding command.

PROGRAMME 1			
MENU LEVEL	SELECTION	MEANING	POSSIBLE VALUES
03 – 03 – 02	START PROG 1	Turn-on time of the first programme	Time – OFF
03 – 03 – 03	STOP PROG 1	Turn-off time of the first programme	Time – OFF
03 – 03 – 04	MONDAY PROG 1	Reference days of the first programme	On/off
03 – 03 – 05	TUESDAY PROG 1		On/off
03 – 03 – 06	WEDNESDAY PROG 1		On/off
03 – 03 – 07	THURSDAY PROG 1		On/off
03 – 03 – 08	FRIDAY PROG 1		On/off
03 – 03 – 09	SATURDAY PROG 1		On/off
03 – 03 – 10	SUNDAY PROG 1		On/off

PROGRAMME 2			
MENU LEVEL	SELECTION	MEANING	POSSIBLE VALUES
03 – 03 – 11	START PROG 2	Turn-on time of the second programme	Time – OFF
03 – 03 – 12	STOP PROG 2	Turn-off time of the second programme	Time – OFF
03 – 03 – 13	MONDAY PROG 2	Reference days of the second programme	On/off
03 – 03 – 14	TUESDAY PROG 2		On/off
03 – 03 – 15	WEDNESDAY PROG 2		On/off
03 – 03 – 16	THURSDAY PROG 2		On/off
03 – 03 – 17	FRIDAY PROG 2		On/off
03 – 03 – 18	SATURDAY PROG 2		On/off
03 – 03 – 19	SUNDAY PROG 2		On/off

PROGRAMME 3			
MENU LEVEL	SELECTION	MEANING	POSSIBLE VALUES
03 – 03 – 20	START PROG 3	Turn-on time of the third programme	Time – OFF
03 – 03 – 21	STOP PROG 3	Turn-off time of the third programme	Time – OFF
03 – 03 – 22	MONDAY PROG 3	Reference days of the third programme	On/off
03 – 03 – 23	TUESDAY PROG 3		On/off
03 – 03 – 24	WEDNESDAY PROG 3		On/off
03 – 03 – 25	THURSDAY PROG 3		On/off
03 – 03 – 26	FRIDAY PROG 3		On/off
03 – 03 – 27	SATURDAY PROG 3		On/off
03 – 03 – 28	SUNDAY PROG 3		On/off

PROGRAMME 4			
MENU LEVEL	SELECTION	MEANING	POSSIBLE VALUES
03 – 03 – 29	START PROG 4	Turn-on time of the fourth programme	Time – OFF
03 – 03 – 30	STOP PROG 4	Turn-off time of the fourth programme	Time – OFF
03 – 03 – 31	MONDAY PROG 4	Reference days of the fourth programme	On/off
03 – 03 – 32	TUESDAY PROG 4		On/off
03 – 03 – 33	WEDNESDAY PROG 4		On/off
03 – 03 – 34	THURSDAY PROG 4		On/off
03 – 03 – 35	FRIDAY PROG 4		On/off
03 – 03 – 36	SATURDAY PROG 4		On/off
03 – 03 – 37	SUNDAY PROG 4		On/off

### Sub-menu 03 – 04 – week-end program

Enables/disables/sets the programmable timer's weekend functions (Saturday and Sunday).

MENU LEVEL	SELECTION	MEANING	POSSIBLE VALUES
03 – 04 – 01	CHRONO WEEK-END	Enable/disable the weekend programme	ON – OFF
03 – 04 – 02	START 1st WEEKEND	Turn-on time of the first programme	Time – OFF
03 – 04 – 03	STOP 1st WEEKEND	Turn-off time of the first programme	Time – OFF
03 – 04 – 04	START 2nd WEEKEND	Turn-on time of the second programme	Time – OFF
03 – 04 – 05	STOP 2nd WEEKEND	Turn-off time of the second programme	Time – OFF

**TIP:** in order to avoid confusion and any undesired switching on/off operations, only activate a single programme at a time (daily, weekly or weekend programme).

Deactivate the daily program if you wish to use the weekly program instead. If you use the weekly program in programs 1, 2, 3 and 4, always keep the week-end program disabled.

Only enable week-end programming after disabling the weekly program.

### Menu 04 – Choose language

Allows you to select the dialogue language from the available choices (Italian, English, French, German and Spanish).

### Menu 05 – Acoustic alarm

Allows you to enable or disable the acoustic signal in the event of an alarm. The alarm signal is only available on the appliance board, and not on the external "Remote control".

### Menu 06 – Initial load

Enables pellet pre-loading for 180" when the appliance is switched off and cooled down. Start the function with button 1 and stop with button 4. This may be useful if the appliance is switched on after the tank has been completely emptied, or when it is filled for the first time. **Warning: once the operation has been completed, before switching on the appliance you should empty the accumulation of pellets deposited inside the brazier.**

### Menu 07 – Fireplace status

It allows for viewing the instantaneous state of the appliance, by showing the state of the various devices connected to it. Several pages are displayed in succession. The data is reserved for Technical assistance Centre.

**Menu 08 – Technical calibration**

Allows you to access all data reserved for the Technical Assistance Centre. Access is protected by a password. Unauthorised access can cause serious damage to the equipment, to things and the environment as well as personal injuries.

**Menu 09 – System type**

Allows you to configure the appliance according to the type of system it has been connected to (see “[System configuration](#)”).

**Menu 10 – NOT PRESENT****Menu 11 – User calibration**

Menu reserved for expert users only; allows for calibrating pellet loading (LOAD PELLETS) and the flue gas extraction speed (FLUE GAS-EXT CHIMNEY) in a limited manner, according to the procedures indicated in the following table:

<i>Menu</i>	<i>Meaning</i>	<i>Settable values</i>
LOAD PELLETT	By increasing the value by a single unit, the pellet load is increased by about 2%.	-4 / +4
	By reducing the value by a single unit, the pellet load is reduced by about 2%.	
FLUE GAS-EXT CHIMNEY	By increasing the value by a single unit, the flue gas extractor speed (and therefore the flow of combustion air) is increased by about 3%.	-4 / +4
	By reducing the value by a single unit, the flue gas extractor speed (and therefore the flow of combustion air) is reduced by about 3%.	

**\* Unauthorised access can cause serious damage to equipment, objects and the environment, as well as personal injuries. Klover declines all responsibility deriving from improper calibration of these values.**

## INITIAL START-UP

### System configuration

Before commissioning the appliance it is advisable to choose which type of system it has been connected to, by accessing "Menu 06 – System type".

The available configurations are given here below:

**PLUMBING LAYOUT "1"** – Boiler stove connected to a heating system and (potentially) an external plate heat exchanger for the production of DHW.

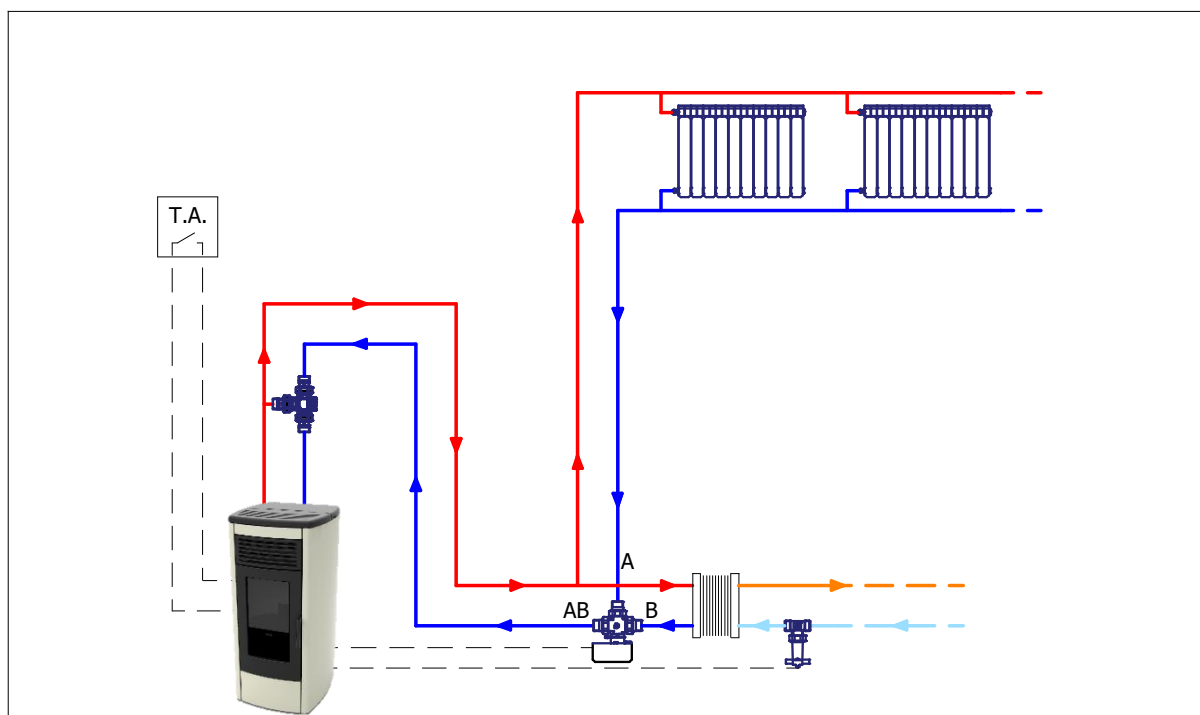

Plumbing layout 1 involves connecting the boiler stove to a heating system (or centralised puffer) managed by one or more room thermostats. These are connected to the terminal located inside the appliance's left technical compartment. DHW generation, where required, will be obtained through a plate heat exchanger fitted outside of the boiler stove and controlled by a flow switch, which is also connected to a terminal on the boiler stove. This function of this switch is to bring the appliance immediately to the DHW output working mode and to switch a three-way motor-driven valve to give it priority.

**PLUMBING LAYOUT "2"** – Not used

**PLUMBING LAYOUT "3"** – Boiler stove connected to a heating system and a DHW cylinder.

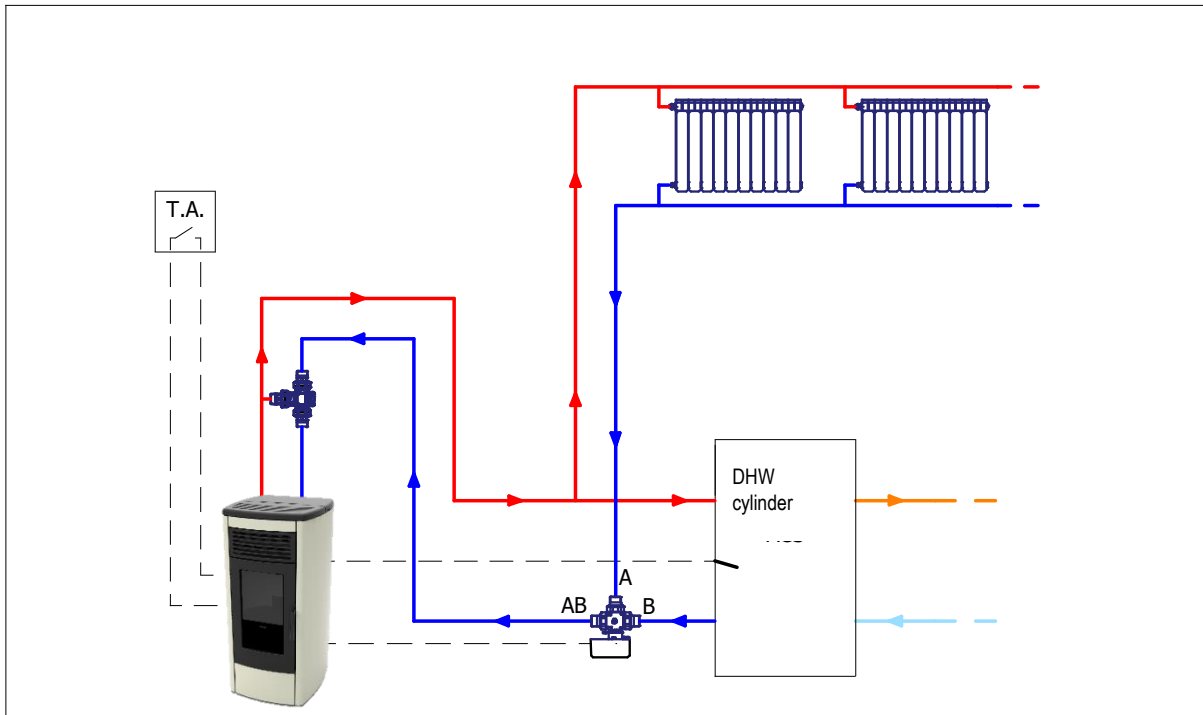

Plumbing layout 3 involves connecting the boiler stove to a heating system managed by one or more room thermostats. These are connected to the terminal located inside the appliance's left technical compartment. DHW will be generated by means of a hot water cylinder fitted outside of the boiler and controlled by a temperature probe connected to the appliance.

The three-way motor-driven valve, controlled by the pellet boiler stove, will manage heating of the system or hot water cylinder, giving priority to the latter.

Setting "Menu 01 – Select season" to SUMMER allows for controlling the hot water cylinder only during summer (thus with the heating system off).

**PLUMBING LAYOUT "4"** – Boiler stove connected to a centralised puffer controlled by an H<sub>2</sub>O probe connected to the boiler stove.

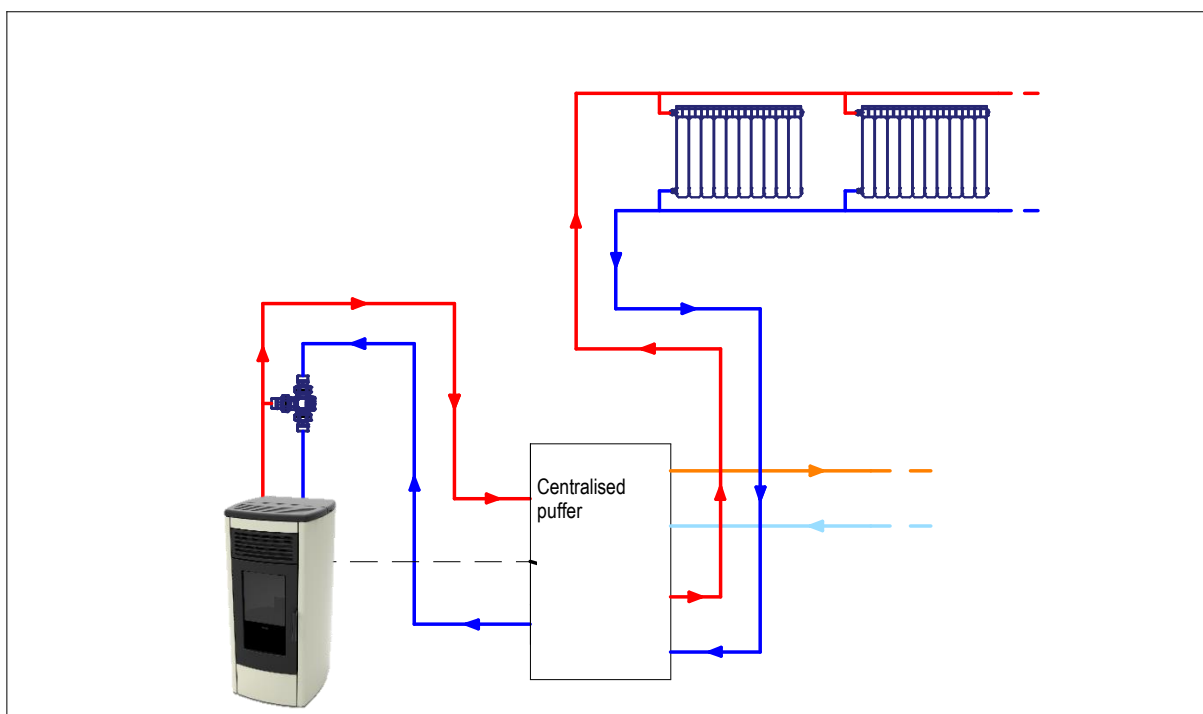

Plumbing layout 4 involves connecting the boiler to a centralised puffer controlled by a temperature probe connected to the appliance. The boiler stove will therefore operate only at the set temperature of the centralised puffer (“*SET PUFFER*” can be set using buttons 1 and 2). In this type of system there are no room thermostats or three-way valves connected to the pellet boiler stove.

---

### Initial filling of the system

After the water connection of the appliance, fill the system as follows:

- Check the seal of all piping, the expansion vessel, and the circulation pump;
- Open the “*automatic air release valve*” on the appliance;
- Open the system load cock (mounted on the appliance) to load the system. Gradually allow the air to come out from the appliance through the “*automatic air release valve*”; **optimum working pressure is 1.5 bar (when the appliance is operating)**;
- Vent all radiators and any other de-aeration systems to ensure that there are no air bubbles in the system.

After installation, check the seal of all plumbing joints for the first few days of operation.

The system and the water inside the boiler can be emptied by opening the “*boiler body and system drain cock*” situated inside the appliance.

**In intensely cold periods it is good practice to leave the heating system running. In the event of a prolonged absence, anti-freeze must be added to the heating water or the system must be completely emptied.**

In a system subject to being emptied frequently, it is essential that filling is performed with water suitably treated to remove hardness which can give rise to scaling.

---

### Pellet loading and connection to the mains power supply

Perform the following operations:

- Connect the appliance to the electrical system by using the provided cable;
- Set the “*power ON/OFF switch*” on the front of the appliance to “1” (on);
- Fill the pellet tank; for the first ever ignition, to avoid wasting the time required for filling the entire screw feed channel (**this should be done every time the appliance runs out of pellets**), we recommend you follow the instructions in the “*Menu 06 – Initial load*”;
- Switch the appliance on by using the ignition button on the display (button 4). See the instructions below. **Warning: before switching on the device make sure that there are no pellets in the brazier; otherwise it is necessary to empty and clean the brazier.**

**We recommend that you use high quality pellets so as not to impair the operation of the appliance. Damage caused by poor-quality pellets shall not be covered by the warranty.**

**Do not pour pellets directly into the brazier.**

---

### Ignition cycle

Pressing button 4 (ON/OFF) for a few seconds allows you to start the ignition cycle. After a while, the display shows “**START**”, and the flue gas intake device and ignition plug switch on and an automatic brazier cleaning cycle is performed. After a few seconds, with the brazier being realigned, the appliance enters a pre-load phase “**PELLET P-LOAD**” during which a continuous supply of pellets is loaded. After the pre-loading phase the appliance switches to the “**FLAME STAND-BY**” phase where the pellets are loaded into the brazier at regular intervals. When the flame is lit, the display shows the message “**FIRE ON**”. This step is used to allow the fire to spread evenly across the brazier and burn all the unburned pellets from the previous phases. After these phases, the appliance enters the work mode at the pre-set power value.

If the ignition fails, the display will show the alarm “**NO IGNIT ALARM**”. **The alarm may also occur if the brazier is dirty; in this case, clean the brazier and re-start.**

**Summary:**

The ignition cycle can last 20/25 minutes max. and is divided into five steps:

- Step 1 - START = Flue gas intake device switches on and automatic brazier cleaning.
- Step 2 - WAITING PREHEATING = Waiting for the plug preheating. (Not as standard settings).
- Step 3 - PELLETT P-LOAD = Pellet pre-load (initial continuous load) and plug ignition.
- Step 4 - FLAME STAND-BY = Loading pellets (intermittent load) and plug operating.
- Step 5 - FIRE ON= Plug switch-off and flame stabilisation.

The appliance switches into working mode after ignition phase at the power output set during ignition via buttons 1 and 2.

**Warning: during the ignition phase and normal operation of the appliance, maintain the necessary safety distance and do not stand in front of it.**

**Switch-off cycle**

The appliance switches off if you press button 4 (ON/OFF) during normal operation. The display will show **"FINAL CLEANING"**. The pellet loading stops and the flue gas extractor speed increases to maximum and then switches off after the cooling of the appliance, displaying **"OFF"**.

If button 4 (ON/OFF) is pressed during the ignition cycle, the appliance switches to **"WAITING OFF"** and the appliance will be turned off only at the end of the entire cycle; if, however, button 4 (ON/OFF) is pressed by mistake during this phase, you only need to press it again to delete **"WAITING OFF"**: the appliance will return to normal operation at the end of the entire ignition cycle. An automatic brazier cleaning cycle is carried out during the **"FINAL CLEANING"** phase.

**Modifying the working power**

To modify the maximum working power you must select **"SET POWER"** by pressing buttons 5 or 6. Press buttons 5 and 6 to change the setting. During this operation, the display will appear as in the following picture.



After setting the desired value, press button 4 or wait a few seconds to confirm.

**Changing the water temperature boiler or puffer****- Boiler Water Temperature**

For system types 1, 2 and 3, to modify the boiler water temperature, simply select **"SET H2O"** by pressing button 2. Now use buttons 1 and 2. During this operation, the display will appear as in the following picture.

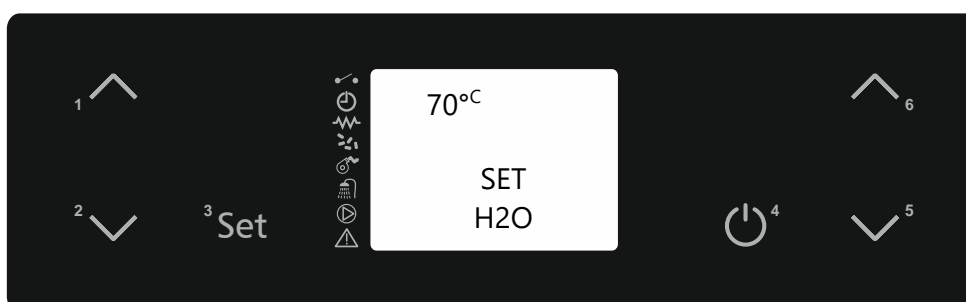

After setting the desired value, press button 4 or wait a few seconds to confirm.

During the working mode the appliance enters “*Economy mode operation*” when that temperature value is reached.

#### - DHW cylinder temperature

For system type 3, to modify the boiler temperature, simply select “*SET BOILER*” by pressing button 1. Now use buttons 1 and 2. During this operation, the display will appear as in the following picture.

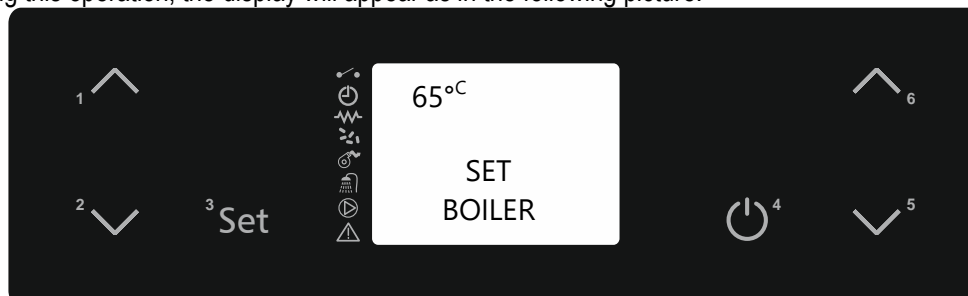

After setting the desired value, press button 4 or wait a few seconds.

During the working phase, if the boiler is in demand the appliance will switch to “*Economy mode*” if  $T.H2O > SET BOILER + 10^{\circ}C$ .

Here below are the operating modes in the event that the “*SET BOILER*” temperature is reached:

- “Menu 01 – Select season = SUMMER” the appliance will immediately go into stand-by “*STOP FIRE*”.
- “Menu 01 – Select season = WINTER” the motorised three-way valve and the appliance will go into stand-by “*STOP FIRE*” only if the conditions in the heating system are satisfied.

#### - Puffer temperature

For system type 4, to modify the puffer temperature, simply select “*SET PUFFER*” by pressing buttons 1 or 2. Now use buttons 1 and 2. During this operation, the display will appear as in the following picture.



After setting the desired value, press button 4 or wait a few seconds.

During the working phase the appliance will switch to “*Economy mode*” if  $T.H2O > SET PUFFER + 10^{\circ}C$ .

The appliance will enter the “*STOP FIRE*” stand-by mode only if the “*SET PUFFER*” temperature is reached.

### Changing the air fan speed

To modify the air fan speed, simply select “*SET AIR*” by pressing button 5. Now use buttons 5 and 6. During this operation, the display will appear as in the following picture.

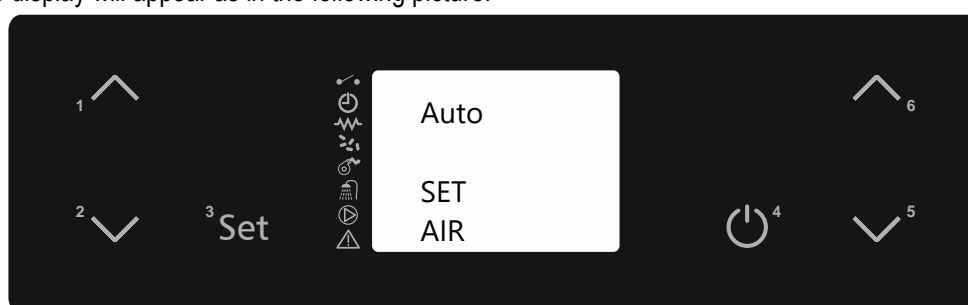

The air fan can be switched off (“*OFF*”), manually set to a speed value (of between 1 and 5), or set to automatic mode (“*Auto*”), in which case the fan speed is associated with the operating power value set under *SET POWER*. After setting the desired value, press button 4 or wait a few seconds.



## PROBLEMS, ALARMS, USEFUL TIPS

---

### Useful info...

Listed below is some important information regarding the appliance:

- It is normal for the appliance to emit a smell of paint during its first few days of operation. We recommend properly ventilating the installation room during the initial start-up. For the first few days of operation we also recommend that you set the appliance to near-maximum level.
- The boiler unit is treated with anti-oxidant paint in order to protect it against oxidation in the event of long periods of inactivity. After initial start-up, this paint no longer preserves its original features and any wear of the paint inside the combustion chamber should not be regarded as a manufacturing fault.
- Do not clean with water inside the combustion chamber; any oxidation of the combustion chamber after a long period of inactivity is not to be considered as a manufacturing fault.
- Any perceived noise during operation may be caused by the expansion settling of the plates that make up the boiler unit. These noises are accentuated especially during ignition and switching off phases of the appliance and are not to be considered a manufacturing fault.
- **If ignition fails, empty the pellets out of the brazier; only then can you reignite the appliance in order to avoid gasification and consequent "explosion" during ignition which could lead to the breakage of the door glass.**
- The appliance works exclusively with wooden pellets; do not burn different fuels.
- The appliance can work only if connected to the heating system and with water inside the boiler unit. Do not start the appliance for any reason if a plumbing connection in compliance with current regulations has not been done and if you have not filled the entire boiler unit and system with water in order not to compromise its life.
- The noise heard during the ignition and switching off stage is due to the automatic cleaning of the brazier.
- The noise level of the appliance is emphasised if the pellet container is empty. Therefore we recommend that you always keep the pellet level to at least half tank.
- If there is soot and fine particulate in the room where the appliance is installed, check the seal on the flue gas pipes and the filter of the ash vacuum device used for cleaning.
- In the event of overheating, the appliance will switch off when it reaches 85°C.

### What happens if...

---

#### ...the pellets do not ignite

If the ignition fails, the display will show the alarm message "NO IGNIT ALARM".

Cancel the alarm and reset the appliance to standard condition by pressing button 4 for a few seconds.

**If ignition fails, empty the pellets out of the brazier; to avoid gasification, the appliance can only be re-ignited after having emptied the un-burnt pellets.**

#### ...the combustion chamber door is open or not properly closed

If the door is left open or not properly closed, the pellet loading will not start, therefore the appliance will not switch itself on. If the door is opened during normal operation, the appliance switches to "THERMAL SAFETY" alarm.

#### ...the flue pipe is dirty, blocked or not correctly installed

If the flue is dirty, blocked or incorrectly manufactured, pellet loading will not start, thus the appliance will not switch itself on. If the flue is obstructed during normal operation, the appliance activates the "DEPRESS.-FAILURE" alarm.

#### ...the appliance is overheated

If the water in the boiler body is overheated (>94°C), the pellet will not be loaded because the manual reset thermostat cuts in. If this happens during normal operation, the appliance switches to "THERMAL SAFETY" alarm. It is therefore necessary to reset the "manual reset thermostat" (see "Components of the appliance") before switching the appliance on again. To reset, it is necessary to remove the black cap and press the button below.

#### ...lack of power (blackout)

If a power blackout occurs for a shorter time than Pr48, when power is restored, the appliance will immediately re-start in the working mode (recovering the set working power).

If the outage lasts longer than Pr48, when power is restored, the appliance will enter the “STOP FIRE” (*stand-by*) mode running the entire switch-off cycle until cooling. When this phase is over, the appliance can be restarted resuming work at the set power.

Previous state	Black-out duration	State after power restore
OFF	any	OFF
START	duration < Pr48	START
START	duration > Pr48	START
P-LOAD PELLETT	any	BLACK OUT ALARM
FLAME STAND-BY	any	BLACK OUT ALARM
FIRE ON	duration < Pr48	FIRE ON
FIRE ON	duration > Pr48	STOP FIRE with automatic re-ignition after machine cooling
WORK (any phase)	duration < Pr48	WORK (any phase)
WORK (any phase)	duration > Pr48	STOP FIRE with automatic re-ignition after machine cooling
BRAZIER CLEANING	duration < Pr48	BRAZIER CLEANING
BRAZIER CLEANING	duration > Pr48	STOP FIRE with automatic re-ignition after machine cooling
FINAL CLEANING	duration < Pr48	FINAL CLEANING and after cooling → OFF
FINAL CLEANING	duration > Pr48	FINAL CLEANING and after cooling → OFF
STOP FIRE	any	STOP FIRE

## Alarm signals

The following table describes the different alarms which may appear.

DISPLAY VISUALISATION	ORIGIN OF ALARM
AL 1 - BLACK OUT ACTIVE ALARM	Black-out alarm. When power is cut off under determined conditions (see “What happens if...”)
AL 2 - FLUE GAS PROBE ACTIVE ALARM	Faulty or disconnected flue gas temperature probe.
AL 3 - HOT TEMP ACTIVE ALARM	Flue gas over-temperature. Before displaying the alarm, or when flue gas maximum temperature is reached (Pr14), the display shows “HOT FLUE GAS”.
AL 4 - EXTRACTOR-FAILURE ACTIVE ALARM	Faulty flue gas extractor. When the encoder (tachometer) in the extractor detects an extractor speed equal to 0.
AL 5 - NO IGNITION ACTIVE ALARM	No ignition. When the flue gas minimum temperature (Pr13) is not reached within the maximum ignition cycle time (Pr01).
AL 6 - NO PELLETT ACTIVE ALARM	Sudden shut-down during the work phase. When, during the work phase, the flue gas temperature drops below the minimum threshold (Pr28).
AL 7 - THERMAL-SAFETY ACTIVE ALARM	Temperature safety device. When the safety thermostat (water over temperature) or one of the fire door closing micro switches (contact interrupted) cuts in. If the safety thermostat cuts in the boiler stove must be manually rearmed.
AL 8 - DEPRESS.-FAILURE ACTIVE ALARM	Poor depression. When the flue gas pressure switch cuts in (contact interrupted) due to poor draught in the flue pipe.
AL 9 - WATER PROBE ACTIVE ALARM	Faulty or disconnected water temperature probe.
AL c - SF TRIAC ERROR ACTIVE ALARM	Screw feed TRIAC error. When the screw feed gear motor does not stop for at least 0.2 seconds during the maximum work interval of 8.0 seconds. Before the alarm is activated a safety relay cuts in and forcibly cuts off the power supply to the gear motor.
AL E – CLEANER FAULT	This occurs when the brazier is not correctly aligned during the cleaning phase (initial or during shut-down).

Every alarm causes the appliance to switch-off immediately. The alarm status is reached after the time set on Pr11 (set by default to 90 sec) and can be reset by pressing and holding button 4.

## CLEANING AND MAINTENANCE

### Precautions before cleaning

Before carrying out any cleaning or maintenance operations, make sure that:

- the appliance is off and has cooled down completely;
- the ash is completely cold.
- the rear switch ("Anti-interference filter") is set to "0" (off).
- the ash vacuum device used for cleaning is suitable and its filter is in good condition.

Before re-starting the appliance, re-install all previously removed components, and check the tightness of the seals.

During cleaning operations, use the personal protection devices specified in Directive 89/391/EEC.

The frequency for cleaning depends on the type and quality of pellet burnt; therefore, the indicated times may change.

**Any problem affecting the appliance caused by lack of cleaning will not be covered by the warranty. The failure of these operations could affect the safety of the product.**

Cleaning operations may be carried out by the end user, as indicated in the paragraph below.

### Routine cleaning

The routine cleaning of the appliance must be done at least every 5 days of operation or after 20 ignition cycles, so as to always guarantee efficient performance and optimal operation. Please proceed as follows:

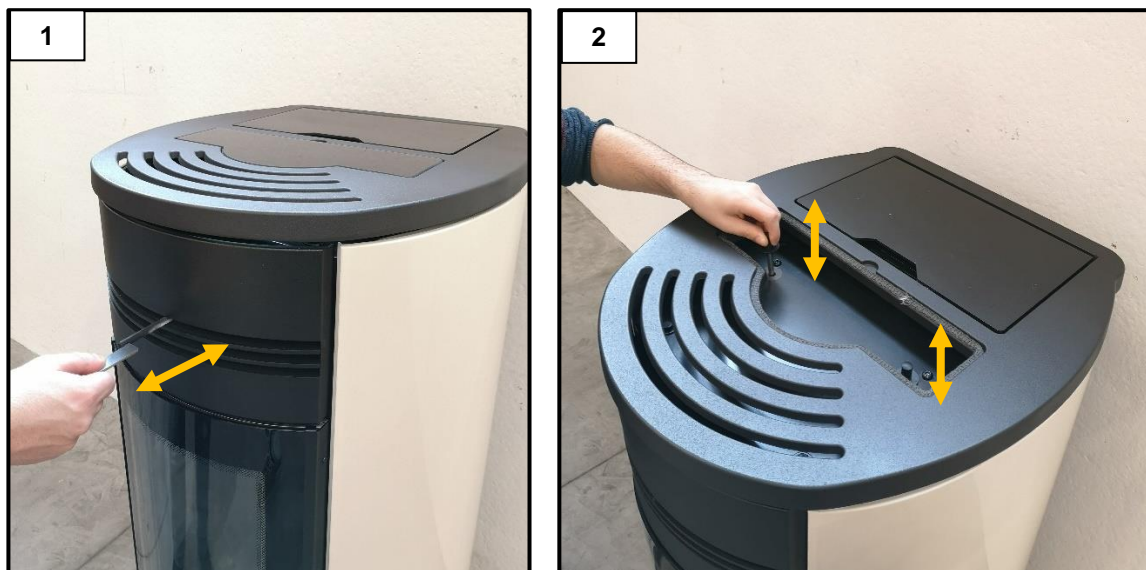

Use the dedicated *cleaning hook for the front scraper* to operate the front rod, moving it forward and backwards to clean off combustion residues from the air exchanger (Figure 1). Also operate the two upper knobs, moving them from the bottom upwards to clean the internal flue gas turn (Figure 2).

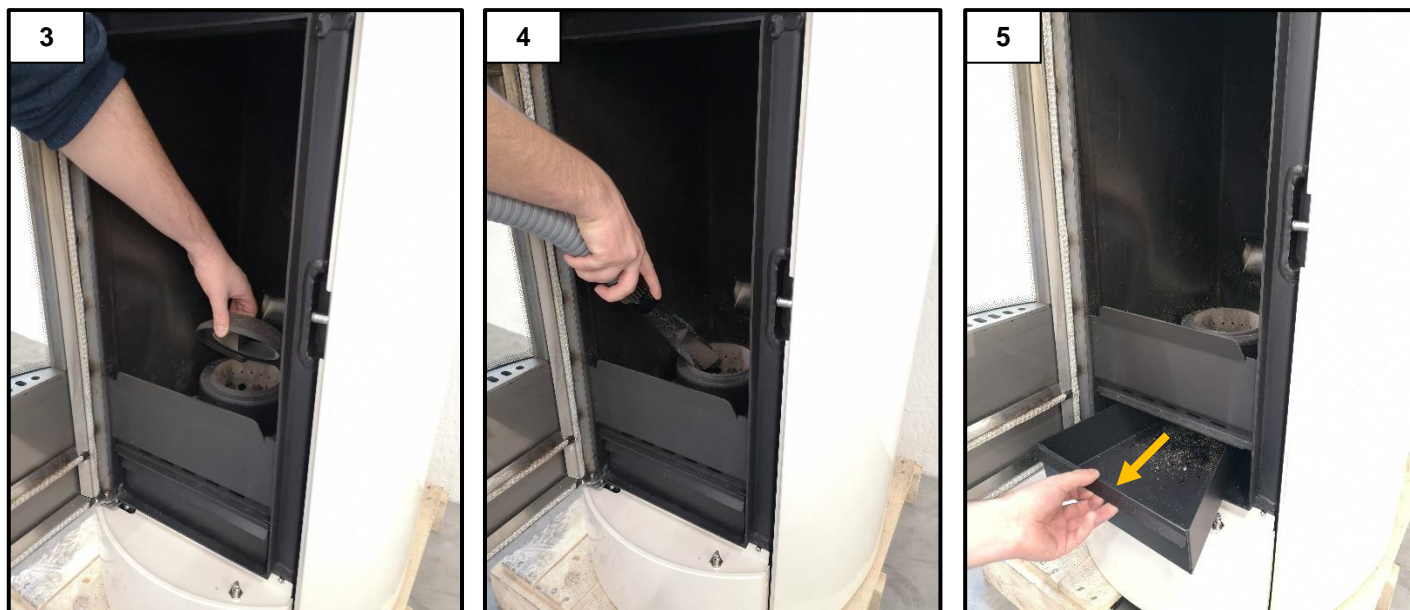

After having removed the upper collar of the brazier (Figure 3), thoroughly clean the bottom of the brazier to eliminate any residues. Use a suitable ash vacuum device to remove any ash deposited around the brazier (Figure 4). Then, empty the ash box (Figure 5).

To remove any deposits, it is also recommended that you scrape the inner walls of the combustion chamber with a spatula. Do not use tools that can reduce the thickness of the metal sheet of the boiler unit.

**WARNING: use suitable ash vacuum devices equipped with a fine mesh filter in order to prevent ash from being blown into the room and to prevent damaging the vacuum cleaner. We do not recommend the use of normal vacuum cleaners.**

---

### Non-routine cleaning

The extraordinary cleaning of the appliance must be done at least every 90 days so as to always guarantee efficient performance and optimal operation. Please proceed as follows:

Perform routine cleaning;



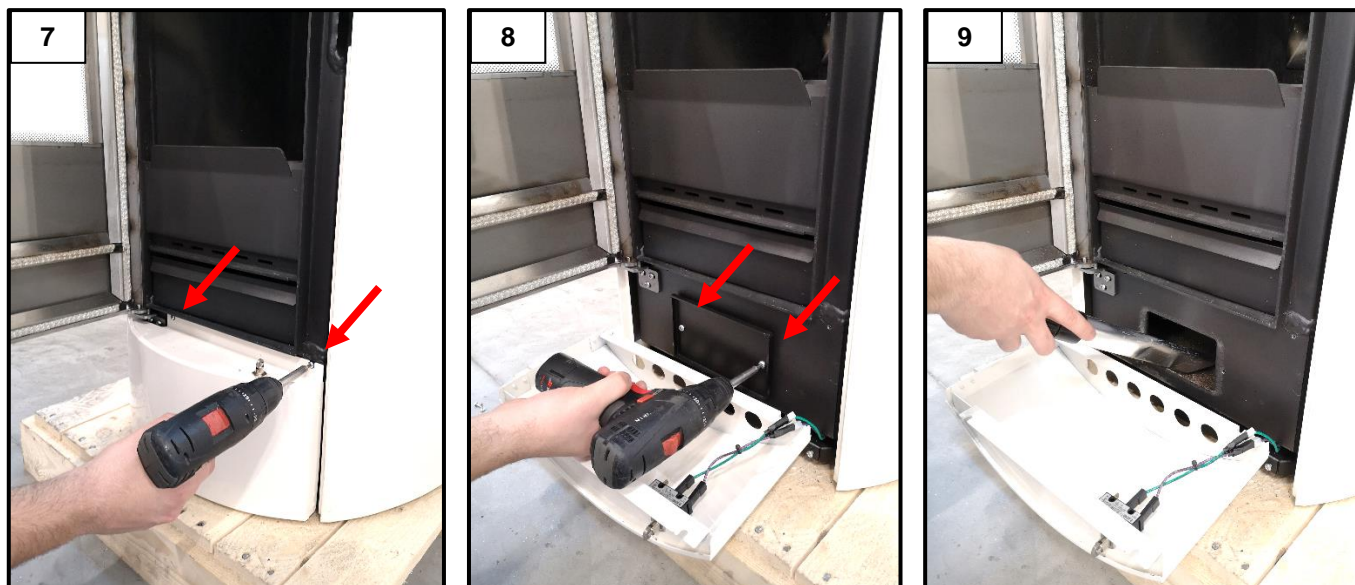

After removing the underlying front panel (Figure 7), remove the cover of the inspection port by loosening the two screws (Figure 8).

Then, vacuum the residues inside the inspected compartment (Figure 9).  
After completing this operation, put the previously removed components back in place.



To ensure correct operation, it is necessary to remove the sawdust deposited on the bottom of the tank (Figure 10) at least once every 30 days. **The pellet tank must be emptied at the end of every season.**

## Annual cleaning

The annual cleaning of the appliance must be done at least once a year so as to always guarantee efficient performance and optimal operation. **To complete these operations, we recommend contacting the *Authorised Technical Assistance Centre***, which will proceed as explained below:

Perform routine and extraordinary cleaning;



After removing the upper top by unscrewing the two screws highlighted in the photo (Figure 11), loosen the two side screws on the right-hand side panel (Figure 12).



After removing the right-hand side panel (Figure 13), remove the right-hand support bracket by unscrewing the two screws highlighted in the photo (Figure 14).



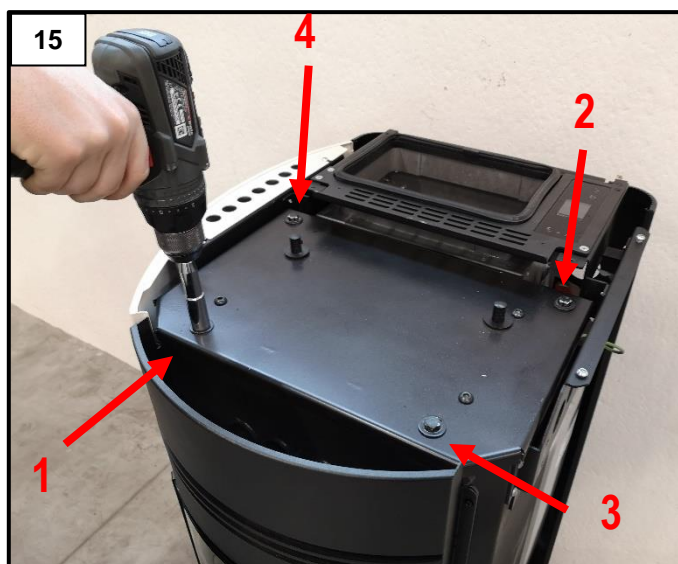

Unscrew the four hex-headed screws, following the sequence given in the photo (Figure 15).  
Then, unscrew the two knobs and washers (Figure 16).



Remove the upper cap (Figure 17), fully sliding out the internal scrapers in an upwards direction (Figure 18).

Vacuum the ash residues from the flue gas turn and combustion chamber.

Once the operation is complete, reposition the components previously removed; the hex-headed screws for the upper cap should be screwed in the sequence shown in Figure 15.

### Cleaning the ceramic glass

Always clean the glass when the appliance is off and has cooled down completely. Use a damp cloth or a detergent specifically formulated for ceramic glass. Do not use abrasive sponges. Do not clean the glass if still warm; changes in temperature can lead to breakage.

---

## Cleaning the flue

The flue must be cleaned at least once a year, at the beginning of winter, and whenever it becomes necessary. It is important to check for any obstructions in the flue before switching the appliance on following long periods of inactivity.

If the flue is not cleaned, the operation of the appliance and its components may be compromised.

**The cleaning frequency of the appliance and flue depends on the quality of the pellets used.**

USE TOP QUALITY PELLETS TO OBTAIN THE BEST RESULTS.

---

## Maintenance

Timely and systematic maintenance is essential for guaranteeing correct operation, optimal heat performance and durability of the device. Therefore, qualified staff should check the appliance at least once a year at the beginning of the season.

You must periodically check the seals because the latter guarantee the air- and water-tightness of the appliance and its good functioning; if they are worn or damaged you need to be replace them immediately by contacting a ***Klover Authorised technical assistance centre***.

**For proper operation, the appliance must undergo routine maintenance performed by a *Klover Authorised technical assistance centre* at least once a year.**



## PCB PARAMETERS

The parameters stored on the PCB are essential for the correct operation.

The following parameters are already stored during the testing of the appliance directly in the factory; these parameters are the result of special tests using several types of pellets and must not be changed without the authorisation of Klover srl so as not to impair the operation of the appliance.

**The company shall not be held liable for any damage caused by the incorrect entry of parameters.**

### Parameter tables STYLE 140

Parameters "VARIOUS SETTINGS" - Mod. SL140 (N04_071119)						
Parameter	Menu level	Description	Display	Measurement	Value field	Database P0
Pr38	M08 - 4 - 01	Re-ignition block	RE-IGNIT BLOCK	Minutes	0 - 10	6
Pr39	M08 - 4 - 02	Flue gas extractor switch-off time	MIN-EXT OFF	Minutes	0 - 20	10
Pr40	M08 - 4 - 03	Pre-loading time in ignition	IGNIT PRE-LOAD	Seconds	0 - 255	150
Pr41	M08 - 4 - 04	Stand-by time after pre-loading	AFTER-PRE STAND-BY	Seconds	0 - 255	80
Pr42	M08 - 4 - 05	Extractor speed in pre-loading phase	FLUE GAS-EXT PRELOAD	RPM	350 - 2800	2300
Pr43	M08 - 4 - 06	ON/OFF temperature hysteresis on "SET H2O"	DELTA ON OFF AUTO	°C	0.0 - 20.0	5.0
Pr44	M08 - 4 - 07	Delay at economy operation mode switch-off (timer after exceeding "SET H2O + Pr43")	DELAY-OFF AUTO	Minutes	2 - 120	10
Pr45	M08 - 4 - 08	Power change delay	POWER CHANGE	Seconds	0 - 60	20
Pr46	M08 - 4 - 09	ON/OFF Temperature hysteresis on "SET ROOM"	DELTA ON AUTO	°C	0.0 - 15.0	2.0
Pr47	M08 - 4 - 10	Keypad lock enable	KEY LOCK-EN	On - off	On - off	Off
Pr48	M08 - 4 - 11	Time after which an alarm is triggered in the event of a blackout	BLACKOUT ALARM	Seconds	0 - 60	30
Pr49	M08 - 4 - 12	Pellet level sensor enable and type	PELLET RESERVE	Off / Type	"Off" disabled "Opt" optical "Cap" capacitive	Off
Pr50	M08 - 4 - 13	Pump start threshold and power modulation for overheating safety	PUMP SAFETY	°C	60 - 90	80
Pr51	M08 - 4 - 14	3-way switching and re-ignition delta on "SET BOILER" and "SET PUFFER"	DELTA PUF-BOI	°C	0 - 15	5
Pr52	M08 - 4 - 15	Preheating time	PRE-HEAT TIME	Seconds	0 - 480	0
Pr53	M08 - 4 - 16	Extractor speed in preheating phase	PRE-HEAT GAS SPEED	RPM	500 - 2800	2800
Pr54	M08 - 4 - 17	Time after which the "NO PELLETT" alarm is triggered if "PELLET RESERVE"	RESERVE ALARM	Minutes	1 - 180	180
Pr55	M08 - 4 - 18	ON time for turbulator cleaning gear motor	TURBOLAT DURATION	Seconds	0 - 600"	0
Pr56	M08 - 4 - 19	ON time for brazier cleaning gearmotor (NOT USED)	CLEANING TIME	Seconds	0 - 120"	13
Pr57	M08 - 4 - 20	Time from switching off after which the brazier cleaning takes place (NOT USED)	CLEANER DELAY	Minutes	1 - 15'	6
Pr58	M08 - 4 - 21	Time from switching on after which the brazier cleaning cycle starts (NOT USED)	CLEANER STAND-BY	Hours	1 - 24	10
Pr59	M08 - 4 - 22	Pump activation threshold and switching 3-way valve in DHW OUTPUT MODE (with Type 2 System)	PUMP THRESHOLD I2	°C	55 - 75	60
Pr142	M08 - 4 - 23	Temperature differential between "SET H2O" and "SET BOILER" or "SET PUFFER", above which the appliance operates in economy mode	DELTA MODULA	°C	1 - 10	5
Pr143	M08 - 4 - 24	Maximum H2O temperature threshold, over which the appliance will shut down independently of other conditions	MAX H2O THRESHOLD	°C	81 - 85	85

Parameters "DEFAULT SETTINGS" - Mod. SL140 (N04_071119)						
Parameter	Menu level	Description	Display	Measurement	Value field	Database P0
Pr01	M08 – 6 – 01	Ignition cycle maximum time	IGNIT- MINUTES	Minutes	5 – 25	18
Pr02	M08 – 6 – 02	Start time	START MINUTES	Minutes	2 – 12	8
Pr03	M08 – 6 – 03	Time interval between the two brazier cleaning operations	BRAZIER CLEANING	Minutes	3 – 240	50
Pr04	M08 – 6 – 04	Screw feed gear motor ON time in ignition phase	IGNIT SCREWS	Seconds	0.1 – 8.0	1.6
Pr05	M08 – 6 – 05	Screw feed gear motor ON time in start phase	START SCREW	Seconds	0.1 – 8.0	1.0
Pr06	M08 – 6 – 06	Screw feed gear motor ON time in power 1 work phase	OUTPUT 1 SCREW FEED	Seconds	0.1 – 8.0	3.0
Pr07	M08 – 6 – 07	Screw feed gear motor ON time in power 2 work phase	OUTPUT 2 SCREW FEED	Seconds	0.1 – 8.0	3.8
Pr08	M08 – 6 – 08	Screw feed gear motor ON time in power 3 work phase	OUTPUT 3 SCREW FEED	Seconds	0.1 – 8.0	4.6
Pr09	M08 – 6 – 09	Screw feed gear motor ON time in power 4 work phase	OUTPUT 4 SCREW FEED	Seconds	0.1 – 8.0	5.8
Pr10	M08 – 6 – 10	Screw feed gear motor ON time in power 5 work phase	OUTPUT 5 SCREW FEED	Seconds	0.1 – 8.0	7.0
Pr11	M08 – 6 – 11	Alarm delay	ALARM DELAY	Seconds	0 – 120	90
Pr12	M08 – 6 – 12	Brazier cleaning duration	BRAZIER CLEANING	Seconds	0 – 120	60
Pr13	M08 – 6 – 13	Flue gas minimum temperature for considering the stove on	MINIMUM THRESHOLD	°C	40 – 600	160
Pr14	M08 – 6 – 14	Flue gas maximum temperature	MAXIMUM THRESHOLD	°C	200 – 880	800
Pr15	M08 – 6 – 15	Flue gas temperature threshold for starting the air exchangers (NOT USED)	BLOWER THRESHOLD	°C	200 – 720	240
Pr16	M08 – 6 – 16	Flue gas extraction speed in ignition phase	IGNIT FL GAS SPEED	RPM	500 – 2800	2200
Pr17	M08 – 6 – 17	Flue gas extraction speed in start phase	START FLUE GAS SPEED	RPM	500 – 2800	2100
Pr18	M08 – 6 – 18	Flue gas extraction speed in power 1 work phase	P 1 FLUE GAS SPEED	RPM	500 – 2800	1800
Pr19	M08 – 6 – 19	Flue gas extraction speed in power 2 work phase	P 2 FLUE GAS SPEED	RPM	500 – 2800	1900
Pr20	M08 – 6 – 20	Flue gas extraction speed in power 3 work phase	P 3 FLUE GAS SPEED	RPM	500 – 2800	2000
Pr21	M08 – 6 – 21	Flue gas extraction speed in power 4 work phase	P 4 FLUE GAS SPEED	RPM	500 – 2800	2100
Pr22	M08 – 6 – 22	Flue gas extraction speed in power 5 work phase	P 5 FLUE GAS SPEED	RPM	500 – 2800	2300
Pr23	M08 – 6 – 23	Heat exchanger 1 motor speed in power 1 work phase (NOT USED)	AIR 1 SPEED	Volt	65 – 225	185
Pr24	M08 – 6 – 24	Heat exchanger 1 motor speed in power 2 work phase (NOT USED)	AIR 2 SPEED	Volt	65 – 225	190
Pr25	M08 – 6 – 25	Heat exchanger 1 motor speed in power 3 work phase (NOT USED)	AIR 3 SPEED	Volt	65 – 225	195
Pr26	M08 – 6 – 26	Heat exchanger 1 motor speed in power 4 work phase (NOT USED)	AIR 4 SPEED	Volt	65 – 225	200
Pr27	M08 – 6 – 27	Heat exchanger 1 motor speed in power 5 work phase (NOT USED)	AIR 5 SPEED	Volt	65 – 225	205
Pr28	M08 – 6 – 28	Threshold beneath which the appliance is considered to be OFF	THRESHOLD OFF	°C	80 – 600	140
Pr29	M08 – 6 – 29	Flue gas extraction speed in brazier cleaning phase	EXHMOTOR CLEANING	RPM	500 – 2800	2800
Pr30	M08 – 6 – 30	Screw feed gear motor ON time in cleaning phase	SCREW CLEANING	Seconds	0.0 – 8.0	1.8
Pr31	M08 – 6 – 31	Flue gas extractor encoder enable (NOT USED)	ENCODER	On – off	On – Off	On
Pr32	M08 – 6 – 32	Screw feed brake time	BRAKE TIME	Seconds	0.0 – 0.5	0.2
Pr33	M08 – 6 – 33	Pump activation threshold	PUMP THRESHOLD	°C	20 – 70	55
Pr34	M08 – 6 – 34	Water pressure switch enable (NOT USED)	WATER MANOSTAT	On – off	On – Off	On
Pr35	M08 – 6 – 35	Water pressure threshold (NOT USED)	PRESSURE THRESHOLD	Bar	1.5 – 3.0	2.5
Pr36	M08 – 6 – 36	Screw feed motor reducer ON time in DHW output working mode	DHW SCREW FEED	Seconds	0.1 – 8.0	7.0
Pr37	M08 – 6 – 37	Flue gas intake speed in DHW output working mode	DHW FLUE GAS DEV	RPM	500 – 2800	2300

**Parameter tables STYLE 180**

Parameters "VARIOUS SETTINGS" - Mod. SL180 (N04_071119)						
Parameter	Menu level	Description	Display	Measurement	Value field	Database n0
Pr38	M08 – 4 – 01	Re-ignition block	RE-IGNIT BLOCK	Minutes	0 – 10	6
Pr39	M08 – 4 – 02	Flue gas extractor switch-off time	MIN-EXT OFF	Minutes	0 – 20	10
Pr40	M08 – 4 – 03	Pre-loading time in ignition	IGNIT PRE-LOAD	Seconds	0 – 255	120
Pr41	M08 – 4 – 04	Stand-by time after pre-loading	AFTER-PRE STAND-BY	Seconds	0 – 255	80
Pr42	M08 – 4 – 05	Extractor speed in pre-loading phase	FLUE GAS-EXT PRELOAD	RPM	350 – 2800	2100
Pr43	M08 – 4 – 06	ON/OFF temperature hysteresis on "SET H2O"	DELTA ON OFF AUTO	°C	0.0 – 20.0	5.0
Pr44	M08 – 4 – 07	Delay at economy operation mode switch-off (timer after exceeding "SET H2O + Pr43")	DELAY-OFF AUTO	Minutes	2 – 120	10
Pr45	M08 – 4 – 08	Power change delay	POWER CHANGE	Seconds	0 – 60	20
Pr46	M08 – 4 – 09	ON/OFF Temperature hysteresis on "SET ROOM"	DELTA ON AUTO	°C	0.0 – 15.0	2.0
Pr47	M08 – 4 – 10	Keypad lock enable	KEY LOCK-EN	On – off	On – off	Off
Pr48	M08 – 4 – 11	Time after which an alarm is triggered in the event of a blackout	BLACKOUT ALARM	Seconds	0 – 60	30
Pr49	M08 – 4 – 12	Pellet level sensor enable and type	PELLET RESERVE	Off / Type	"Off" disabled "Opt" optical "Cap" capacitive	Off
Pr50	M08 – 4 – 13	Pump start threshold and power modulation for overheating safety	PUMP SAFETY	°C	60 – 90	80
Pr51	M08 – 4 – 14	3-way switching and re-ignition delta on "SET BOILER" and "SET PUFFER"	DELTA PUF-BOI	°C	0 – 15	5
Pr52	M08 – 4 – 15	Preheating time	PRE-HEAT TIME	Seconds	0 – 480	0
Pr53	M08 – 4 – 16	Extractor speed in preheating phase	PRE-HEAT GAS SPEED	RPM	500 – 2800	2800
Pr54	M08 – 4 – 17	Time after which the "NO PELLETT" alarm is triggered if "PELLET RESERVE"	RESERVE ALARM	Minutes	1 – 180	180
Pr55	M08 – 4 – 18	ON time for turbulator cleaning gear motor	TURBOLAT DURATION	Seconds	0 – 600"	0
Pr56	M08 – 4 – 19	ON time for brazier cleaning gearmotor (NOT USED)	CLEANING TIME	Seconds	0 – 120"	13
Pr57	M08 – 4 – 20	Time from switching off after which the brazier cleaning takes place (NOT USED)	CLEANER DELAY	Minutes	1 – 15'	6
Pr58	M08 – 4 – 21	Time from switching on after which the brazier cleaning cycle starts (NOT USED)	CLEANER STAND-BY	Hours	1 – 24	10
Pr59	M08 – 4 – 22	Pump activation threshold and switching 3-way valve in DHW OUTPUT MODE (with Type 2 System)	PUMP THRESHOLD I2	°C	55 – 75	60
Pr142	M08 – 4 – 23	Temperature differential between "SET H2O" and "SET BOILER" or "SET PUFFER", above which the appliance operates in economy mode	DELTA MODULA	°C	1 – 10	5
Pr143	M08 – 4 – 24	Maximum H2O temperature threshold, over which the appliance will shut down independently of other conditions	MAX H2O THRESHOLD	°C	81 – 85	85

Parameters "DEFAULT SETTINGS" - Mod. SL180 (N04_071119)						
Parameter	Menu level	Description	Display	Measurement	Value field	Database n0
Pr01	M08 – 6 – 01	Ignition cycle maximum time	IGNIT- MINUTES	Minutes	5 – 25	18
Pr02	M08 – 6 – 02	Start time	START MINUTES	Minutes	2 – 12	8
Pr03	M08 – 6 – 03	Time interval between the two brazier cleaning operations	BRAZIER CLEANING	Minutes	3 – 240	50
Pr04	M08 – 6 – 04	Screw feed gear motor ON time in ignition phase	IGNIT SCREWS	Seconds	0.1 – 8.0	1.2
Pr05	M08 – 6 – 05	Screw feed gear motor ON time in start phase	START SCREW	Seconds	0.1 – 8.0	0.8
Pr06	M08 – 6 – 06	Screw feed gear motor ON time in power 1 work phase	OUTPUT 1 SCREW FEED	Seconds	0.1 – 8.0	2.4
Pr07	M08 – 6 – 07	Screw feed gear motor ON time in power 2 work phase	OUTPUT 2 SCREW FEED	Seconds	0.1 – 8.0	3.4
Pr08	M08 – 6 – 08	Screw feed gear motor ON time in power 3 work phase	OUTPUT 3 SCREW FEED	Seconds	0.1 – 8.0	4.5
Pr09	M08 – 6 – 09	Screw feed gear motor ON time in power 4 work phase	OUTPUT 4 SCREW FEED	Seconds	0.1 – 8.0	5.6
Pr10	M08 – 6 – 10	Screw feed gear motor ON time in power 5 work phase	OUTPUT 5 SCREW FEED	Seconds	0.1 – 8.0	6.8
Pr11	M08 – 6 – 11	Alarm delay	ALARM DELAY	Seconds	0 – 120	90
Pr12	M08 – 6 – 12	Brazier cleaning duration	BRAZIER CLEANING	Seconds	0 – 120	60
Pr13	M08 – 6 – 13	Flue gas minimum temperature for considering the stove on	MINIMUM THRESHOLD	°C	40 – 600	160
Pr14	M08 – 6 – 14	Flue gas maximum temperature	MAXIMUM THRESHOLD	°C	200 – 880	800
Pr15	M08 – 6 – 15	Flue gas temperature threshold for starting the air exchangers (NOT USED)	BLOWER THRESHOLD	°C	200 – 720	240
Pr16	M08 – 6 – 16	Flue gas extraction speed in ignition phase	IGNIT FL GAS SPEED	RPM	500 – 2800	2100
Pr17	M08 – 6 – 17	Flue gas extraction speed in start phase	START FLUE GAS SPEED	RPM	500 – 2800	1900
Pr18	M08 – 6 – 18	Flue gas extraction speed in power 1 work phase	P 1 FLUE GAS SPEED	RPM	500 – 2800	1650
Pr19	M08 – 6 – 19	Flue gas extraction speed in power 2 work phase	P 2 FLUE GAS SPEED	RPM	500 – 2800	1750
Pr20	M08 – 6 – 20	Flue gas extraction speed in power 3 work phase	P 3 FLUE GAS SPEED	RPM	500 – 2800	1850
Pr21	M08 – 6 – 21	Flue gas extraction speed in power 4 work phase	P 4 FLUE GAS SPEED	RPM	500 – 2800	2000
Pr22	M08 – 6 – 22	Flue gas extraction speed in power 5 work phase	P 5 FLUE GAS SPEED	RPM	500 – 2800	2150
Pr23	M08 – 6 – 23	Heat exchanger 1 motor speed in power 1 work phase (NOT USED)	AIR 1 SPEED	Volt	65 – 225	185
Pr24	M08 – 6 – 24	Heat exchanger 1 motor speed in power 2 work phase (NOT USED)	AIR 2 SPEED	Volt	65 – 225	190
Pr25	M08 – 6 – 25	Heat exchanger 1 motor speed in power 3 work phase (NOT USED)	AIR 3 SPEED	Volt	65 – 225	195
Pr26	M08 – 6 – 26	Heat exchanger 1 motor speed in power 4 work phase (NOT USED)	AIR 4 SPEED	Volt	65 – 225	200
Pr27	M08 – 6 – 27	Heat exchanger 1 motor speed in power 5 work phase (NOT USED)	AIR 5 SPEED	Volt	65 – 225	205
Pr28	M08 – 6 – 28	Threshold beneath which the appliance is considered to be OFF	THRESHOLD OFF	°C	80 – 600	140
Pr29	M08 – 6 – 29	Flue gas extraction speed in brazier cleaning phase	EXHMOTOR CLEANING	RPM	500 – 2800	2800
Pr30	M08 – 6 – 30	Screw feed gear motor ON time in cleaning phase	SCREW CLEANING	Seconds	0.0 – 8.0	1.8
Pr31	M08 – 6 – 31	Flue gas extractor encoder enable (NOT USED)	ENCODER	On – off	On – Off	On
Pr32	M08 – 6 – 32	Screw feed brake time	BRAKE TIME	Seconds	0.0 – 0.5	0.2
Pr33	M08 – 6 – 33	Pump activation threshold	PUMP THRESHOLD	°C	20 – 70	55
Pr34	M08 – 6 – 34	Water pressure switch enable (NOT USED)	WATER MANOSTAT	On – off	On – Off	On
Pr35	M08 – 6 – 35	Water pressure threshold (NOT USED)	PRESSURE THRESHOLD	Bar	1.5 – 3.0	2.5
Pr36	M08 – 6 – 36	Screw feed motor reducer ON time in DHW output working mode	DHW SCREW FEED	Seconds	0.1 – 8.0	6.8
Pr37	M08 – 6 – 37	Flue gas intake speed in DHW output working mode	DHW FLUE GAS DEV	RPM	500 – 2800	2150

## Parameter tables STYLE 220

Parameters "VARIOUS SETTINGS" - Mod. SL220 (N04_071119)						
Parameter	Menu level	Description	Display	Measurement	Value field	Database n0
Pr38	M08 - 4 - 01	Re-ignition block	RE-IGNIT BLOCK	Minutes	0 - 10	6
Pr39	M08 - 4 - 02	Flue gas extractor switch-off time	MIN-EXT OFF	Minutes	0 - 20	10
Pr40	M08 - 4 - 03	Pre-loading time in ignition	IGNIT PRE-LOAD	Seconds	0 - 255	120
Pr41	M08 - 4 - 04	Stand-by time after pre-loading	AFTER-PRE STAND-BY	Seconds	0 - 255	80
Pr42	M08 - 4 - 05	Extractor speed in pre-loading phase	FLUE GAS-EXT PRELOAD	RPM	350 - 2800	2100
Pr43	M08 - 4 - 06	ON/OFF temperature hysteresis on "SET H2O"	DELTA ON OFF AUTO	°C	0.0 - 20.0	5.0
Pr44	M08 - 4 - 07	Delay at economy operation mode switch-off (timer after exceeding "SET H2O + Pr43")	DELAY-OFF AUTO	Minutes	2 - 120	10
Pr45	M08 - 4 - 08	Power change delay	POWER CHANGE	Seconds	0 - 60	20
Pr46	M08 - 4 - 09	ON/OFF Temperature hysteresis on "SET ROOM"	DELTA ON AUTO	°C	0.0 - 15.0	2.0
Pr47	M08 - 4 - 10	Keypad lock enable	KEY LOCK-EN	On - off	On - off	Off
Pr48	M08 - 4 - 11	Time after which an alarm is triggered in the event of a blackout	BLACKOUT ALARM	Seconds	0 - 60	30
Pr49	M08 - 4 - 12	Pellet level sensor enable and type	PELLET RESERVE	Off / Type	"Off" disabled "Opt" optical "Cap" capacitive	Off
Pr50	M08 - 4 - 13	Pump start threshold and power modulation for overheating safety	PUMP SAFETY	°C	60 - 90	80
Pr51	M08 - 4 - 14	3-way switching and re-ignition delta on "SET BOILER" and "SET PUFFER"	DELTA PUF-BOI	°C	0 - 15	5
Pr52	M08 - 4 - 15	Preheating time	PRE-HEAT TIME	Seconds	0 - 480	0
Pr53	M08 - 4 - 16	Extractor speed in preheating phase	PRE-HEAT GAS SPEED	RPM	500 - 2800	2800
Pr54	M08 - 4 - 17	Time after which the "NO PELLETT" alarm is triggered if "PELLET RESERVE"	RESERVE ALARM	Minutes	1 - 180	180
Pr55	M08 - 4 - 18	ON time for turbulator cleaning gear motor	TURBOLAT DURATION	Seconds	0 - 600"	0
Pr56	M08 - 4 - 19	ON time for brazier cleaning gearmotor (NOT USED)	CLEANING TIME	Seconds	0 - 120"	13
Pr57	M08 - 4 - 20	Time from switching off after which the brazier cleaning takes place (NOT USED)	CLEANER DELAY	Minutes	1 - 15'	6
Pr58	M08 - 4 - 21	Time from switching on after which the brazier cleaning cycle starts (NOT USED)	CLEANER STAND-BY	Hours	1 - 24	10
Pr59	M08 - 4 - 22	Pump activation threshold and switching 3-way valve in DHW OUTPUT MODE (with Type 2 System)	PUMP THRESHOLD I2	°C	55 - 75	60
Pr142	M08 - 4 - 23	Temperature differential between "SET H2O" and "SET BOILER" or "SET PUFFER", above which the appliance operates in economy mode	DELTA MODULA	°C	1 - 10	5
Pr143	M08 - 4 - 24	Maximum H2O temperature threshold, over which the appliance will shut down independently of other conditions	MAX H2O THRESHOLD	°C	81 - 85	85

Parameters "DEFAULT SETTINGS" - Mod. SL220 (N04_071119)						
Parameter	Menu level	Description	Display	Measurement	Value field	Database n0
Pr01	M08 – 6 – 01	Ignition cycle maximum time	IGNIT- MINUTES	Minutes	5 – 25	18
Pr02	M08 – 6 – 02	Start time	START MINUTES	Minutes	2 – 12	8
Pr03	M08 – 6 – 03	Time interval between the two brazier cleaning operations	BRAZIER CLEANING	Minutes	3 – 240	50
Pr04	M08 – 6 – 04	Screw feed gear motor ON time in ignition phase	IGNIT SCREWS	Seconds	0.1 – 8.0	1.2
Pr05	M08 – 6 – 05	Screw feed gear motor ON time in start phase	START SCREW	Seconds	0.1 – 8.0	0.8
Pr06	M08 – 6 – 06	Screw feed gear motor ON time in power 1 work phase	OUTPUT 1 SCREW FEED	Seconds	0.1 – 8.0	2.4
Pr07	M08 – 6 – 07	Screw feed gear motor ON time in power 2 work phase	OUTPUT 2 SCREW FEED	Seconds	0.1 – 8.0	3.4
Pr08	M08 – 6 – 08	Screw feed gear motor ON time in power 3 work phase	OUTPUT 3 SCREW FEED	Seconds	0.1 – 8.0	4.5
Pr09	M08 – 6 – 09	Screw feed gear motor ON time in power 4 work phase	OUTPUT 4 SCREW FEED	Seconds	0.1 – 8.0	5.6
Pr10	M08 – 6 – 10	Screw feed gear motor ON time in power 5 work phase	OUTPUT 5 SCREW FEED	Seconds	0.1 – 8.0	6.8
Pr11	M08 – 6 – 11	Alarm delay	ALARM DELAY	Seconds	0 – 120	90
Pr12	M08 – 6 – 12	Brazier cleaning duration	BRAZIER CLEANING	Seconds	0 – 120	60
Pr13	M08 – 6 – 13	Flue gas minimum temperature for considering the stove on	MINIMUM THRESHOLD	°C	40 – 600	160
Pr14	M08 – 6 – 14	Flue gas maximum temperature	MAXIMUM THRESHOLD	°C	200 – 880	800
Pr15	M08 – 6 – 15	Flue gas temperature threshold for starting the air exchangers (NOT USED)	BLOWER THRESHOLD	°C	200 – 720	240
Pr16	M08 – 6 – 16	Flue gas extraction speed in ignition phase	IGNIT FL GAS SPEED	RPM	500 – 2800	2100
Pr17	M08 – 6 – 17	Flue gas extraction speed in start phase	START FLUE GAS SPEED	RPM	500 – 2800	1900
Pr18	M08 – 6 – 18	Flue gas extraction speed in power 1 work phase	P 1 FLUE GAS SPEED	RPM	500 – 2800	1650
Pr19	M08 – 6 – 19	Flue gas extraction speed in power 2 work phase	P 2 FLUE GAS SPEED	RPM	500 – 2800	1750
Pr20	M08 – 6 – 20	Flue gas extraction speed in power 3 work phase	P 3 FLUE GAS SPEED	RPM	500 – 2800	1850
Pr21	M08 – 6 – 21	Flue gas extraction speed in power 4 work phase	P 4 FLUE GAS SPEED	RPM	500 – 2800	2000
Pr22	M08 – 6 – 22	Flue gas extraction speed in power 5 work phase	P 5 FLUE GAS SPEED	RPM	500 – 2800	2150
Pr23	M08 – 6 – 23	Heat exchanger 1 motor speed in power 1 work phase (NOT USED)	AIR 1 SPEED	Volt	65 – 225	185
Pr24	M08 – 6 – 24	Heat exchanger 1 motor speed in power 2 work phase (NOT USED)	AIR 2 SPEED	Volt	65 – 225	190
Pr25	M08 – 6 – 25	Heat exchanger 1 motor speed in power 3 work phase (NOT USED)	AIR 3 SPEED	Volt	65 – 225	195
Pr26	M08 – 6 – 26	Heat exchanger 1 motor speed in power 4 work phase (NOT USED)	AIR 4 SPEED	Volt	65 – 225	200
Pr27	M08 – 6 – 27	Heat exchanger 1 motor speed in power 5 work phase (NOT USED)	AIR 5 SPEED	Volt	65 – 225	205
Pr28	M08 – 6 – 28	Threshold beneath which the appliance is considered to be OFF	THRESHOLD OFF	°C	80 – 600	140
Pr29	M08 – 6 – 29	Flue gas extraction speed in brazier cleaning phase	EXHMOTOR CLEANING	RPM	500 – 2800	2800
Pr30	M08 – 6 – 30	Screw feed gear motor ON time in cleaning phase	SCREW CLEANING	Seconds	0.0 – 8.0	1.8
Pr31	M08 – 6 – 31	Flue gas extractor encoder enable (NOT USED)	ENCODER	On – off	On – Off	On
Pr32	M08 – 6 – 32	Screw feed brake time	BRAKE TIME	Seconds	0.0 – 0.5	0.2
Pr33	M08 – 6 – 33	Pump activation threshold	PUMP THRESHOLD	°C	20 – 70	55
Pr34	M08 – 6 – 34	Water pressure switch enable (NOT USED)	WATER MANOSTAT	On – off	On – Off	On
Pr35	M08 – 6 – 35	Water pressure threshold (NOT USED)	PRESSURE THRESHOLD	Bar	1.5 – 3.0	2.5
Pr36	M08 – 6 – 36	Screw feed motor reducer ON time in DHW output working mode	DHW SCREW FEED	Seconds	0.1 – 8.0	6.8
Pr37	M08 – 6 – 37	Flue gas intake speed in DHW output working mode	DHW FLUE GAS DEV	RPM	500 – 2800	2150



**WIRING DIAGRAM**

**COMPONENT LEGEND:**

- M1 = screw feeder gear motor
- M2 = Turbulator cleaning gear motor
- M3 = Brazier cleaning gear motor  
*(configured models only)*
- C = Ignition plug
- A = Flue gas extractor with tachometer
- P = Pump
- V = Auxiliary loading vacuum motor  
*(optional configuration)*

FOR THE ELECTRICAL CONNECTION TO THE COUPLED BOILER, IT IS ADVISABLE TO CONNECT A RELAY AT THE OUTPUT OF THE DEDICATED WIRES BECAUSE THESE ARE POWERED AT 230 V.

**Q055 EXPANSION BOARD (OPTIONAL)**

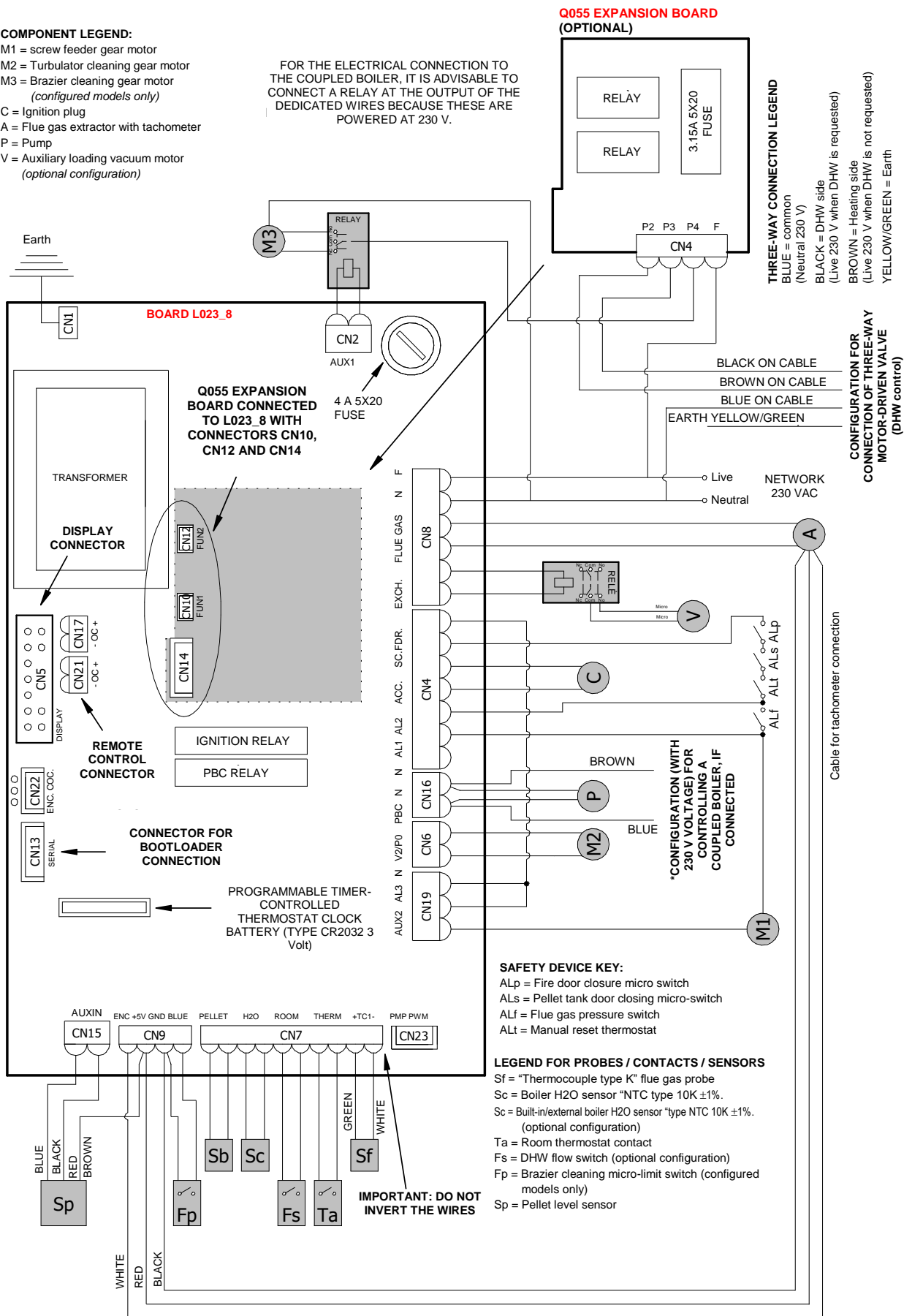

## **STANDARD WARRANTY CONDITIONS**

### **1. General information**

This standard warranty ("**Klover Warranty**") is issued by Klover Srl, San Bonifacio, Via A. Volta no. 8, for the products shown on the website [www.klover.it](http://www.klover.it) (the "**Products**"). The Klover Warranty does not affect the rights provided for by European directive 99/44/EC or by Italian legislative decree no. 206/2005 "Consumer Code", where applicable.

The Klover Warranty is limited to Italy. Klover Srl invites Consumers not based in Italy to contact the dealer from which they bought the Product, to obtain the current warranty conditions.

### **2. Activation of Warranty**

In order for it to be valid and effective, the Klover Warranty must be activated within 60 (sixty) days from the date of purchase on the website [www.klover.it](http://www.klover.it), under the "*Register your warranty*" section. Enter the requested data and attach the delivery note or other tax document proving the purchase (e.g. receipt).

Please ensure that the customer's copy of the Warranty Certificate is retained. It must be duly completed and signed by the Consumer and by the installer. The delivery note or other fiscally valid document proving the purchase should also be retained, in order for the Klover Warranty to be valid.

### **3. Two-year Klover Warranty**

The Klover Warranty covers the free repair of the Product all parts of the Product that are found to be defective at origin, due to defects confirmed by Klover Srl to be exclusively attributable to the manufacturer. If it is not possible to repair the Product in any way, it will be replaced. In both cases, there will be no change to the expiry or terms of the warranty provided when the Product was purchased.

The Klover Warranty offers all the advantages of a service guaranteed directly by Klover Srl through its network of authorised service centres (Centri di Assistenza Tecnica or "**C.A.T.**") in Italy. The list can be found on the website [www.klover.it](http://www.klover.it).

The Klover Warranty will remain in effect for a period of 2 years from the date of purchase, if proven by a delivery note or other proof of purchase (e.g. receipt), stating the name of the seller, the product that was bought, and the date of purchase.

Product components replaced by an authorised dealer at the Consumer's expense as they were "out of warranty" after expiry of the two-year period will be guaranteed by Klover Srl for one year from the date of replacement, excluding costs of intervention, labour and ancillary costs.

### **4. Five-year Klover Warranty**

If the First Switch-on service is provided by an authorised dealer, within 90 days from the date of purchase, the Consumer will be entitled to the Warranty on the main boiler unit for a period of 5 years from the date of purchase.

The cost of the First Switch-on service is paid by the Consumer.

This Klover Warranty is valid on condition that the seasonal maintenance is performed by the local service centre as indicated in the user manual (for example, Safe Top boiler units require annual use of the Long Life protection).

The First Switch-on Report, duly completed and signed, must be kept carefully to ensure that the Klover Warranty remains operational.

### **5. Complaints and Assistance**

As provided for by Legislative Decree 24/2002, complaints should be sent to the retailer through whom the Product was bought.

Once the retailer has checked that the Klover Warranty is in force and has not been invalidated, they will contact the local service centre to agree the terms of intervention to verify and eliminate the reported fault. If the Consumer contacts the service centre directly, the service centre must immediately inform the retailer from whom the Product was bought.

If, while inspecting the Product, the service centre finds that the reported defect is not one of the defects covered by the Warranty, the call-out and any works completed, will be paid by the Consumer.

In order to improve the service and reduce intervention time, Consumers are asked to provide the details of the Product they are calling about. In particular, the following information should be provided: • Warranty Certificate number • the name, model and serial number of the Product • the date of purchase • the reported defect.

Klover Srl will not be liable for any delays in carrying out repairs or replacements of the Product.



## **6. Disclaimer**

Klover Products must undergo functional testing before any related masonry works are carried out (for example before tiling, installation of pilasters, or painting of the walls). Klover Srl is not liable for any costs incurred as a result of removal and/or reconstruction of related installations, or for any other ancillary intervention even if it is the result of works to replace defective parts.

Klover Srl is not liable for any faults in the Product that may be attributable to external conditions and/or events, including but not limited to insufficient installation capacity, mis-installation, lack of maintenance for maintenance not carried out in accordance with the instructions in the user manual, or misuse of the Product. The cost of any works will be paid by the Consumer in such cases.

Klover Srl declines all liability in respect of any loss or damage that may be caused directly or indirectly to the Consumer and/or to a third party or to persons, animals or property as a result of failure to comply with all the relevant instructions concerning installation, use and maintenance of the Product. The injured party must prove the loss or damage, the defect, and the causal connection, and must the retailer from which the Product was bought, in accordance with Legislative Decree 24/2002.

## **7. Exclusions from Klover Warranty**

The Klover Warranty does not include:

- Defects in the Product that are not attributable to manufacturing defects
- Defects in the products related to mis-installation or inappropriate installation
- Defects related to improper functioning of the chimney flue
- Defects in the Product caused by negligence, accidental breakage, normal wear and tear, tampering and/or damage during transport (scratches, dents etc.), including shipments sent free to destination, works carried out by unauthorised personnel, and additional damage caused by inappropriate intervention by the Consumer
- Calibration of settings
- Damage caused by the use of expired or inappropriate fuel
- Transport costs.

The Klover Warranty excludes the following Product components:

- Ceramic or tempered glass, ceramic/majolica tiling and/or lacquered steel and/or cast iron. Changes in colour shades, speckling, superficial cracking, shading and minor dimensional variations are not considered Product defects, but are characteristics of the artisanal manufacturing process
- Painted, chromed or gilded details, handles, dials
- All the external components of the Product on which the Consumer may intervene directly during use and/or maintenance, or which may be subject to wear and tear and/or the formation of rust, or blemishes on the steel caused by harsh detergents, in particular the use of wood at a rate that exceeds the recommended hourly capacity, or the use of fuels that were not recommended or were not included in the instructions
- Refractory materials or vermiculite
- The pellet brazier, grille and cast iron cooking plate, the smoke deflector or flame guard, the seals, fuses or batteries in the Product's electronic components and any other removable component that may be subject to normal wear and tear
- Electrical and electronic parts found to be faulty as a result of non-standard electrical connections, natural disasters or voltage variations other than the nominal variation.

## **8. Forum**

The Court of Verona will have sole jurisdiction in the event of a dispute.







F U O C O E P A S S I O N E

## **KLOVER Srl**

Via A. Volta, 8  
37047 San Bonifacio (VR)  
VAT No. 02324280235  
[www.klover.it](http://www.klover.it)