

ENGLISH

Main Revision 1.0
FPH_supplement: 001

SOFT 80, SOFT 100 pellet-burning stove

INSTALLATION, USE AND
MAINTENANCE, USEFUL ADVICE



KLOVER[®]

FUOCO E PASSIONE

SERVICE DECLARATION

Ref. Annex III EU Regulation no. 305/2011

DoP/KLOVER-048

1. Identification number : **S80**
2. Model and/or lot no. and/or serial no. (Art.11-4) : **SOFT 80**
3. Intended use of the product according to the relevant harmonised technical specification : **Wood pellet-fired domestic heating appliance**
4. Name or trademark of the manufacturer (Art11-5) : **KLOVER s.r.l.**
I - **37047 San Bonifacio (VR) – Via A. Volta, 8**
5. Name and address of the representative (Art.12-2) : -
6. Assessment and verification system of the performance constancy (Annex 5) : **System 3**
7. Notified laboratory : **NB 0476**
KIWA CERMET ITALIA s.p.a.
- Number of test report (based on System 3) : **6002365 / C-387**
8. Declared performances

HARMONISED TECHNICAL SPECIFICATION	EN 14785
PERFORMANCE FEATURES	PERFORMANCE
Fire resistance	A1
Distance from combustible material	200 mm
Fuel spillage risk	Compliant
Emission of combustion products	
- Nominal power	CO at 13% of O2 0.012 %
- Reduced power	CO at 13% of O2 0.054 %
Effective temperature	Compliant
Electrical safety	Compliant
Accessibility and cleaning	Compliant
Maximum operating pressure	-
Mechanical strength	NPD (performance not determined)
Thermal performance	
- Nominal power (reduced)	7.4 kW (2.5 kW)
- Nominal power (reduced) yielded to the environment	7.4 kW (2.5 kW)
Yield	
- Nominal power	η 92.5 %
- Reduced power	η 94.5 %
Flue gas temperature	
- Nominal power	T 115.2 °C
- Reduced power	T 60.0 °C

9. The performance of the product referred to in points 1 and 2 is compliant with the declared performance in point 8.

This declaration is released on the sole responsibility of the manufacturer referred to in point 4.

Signed in the name and on behalf of the manufacturer by:

San Bonifacio (VR), 01/08/2018

Mario Muraro

Chairman of the Board

SERVICE DECLARATION

Ref. Annex III EU Regulation no. 305/2011

DoP/KLOVER-049

1. Identification number : **S100**
2. Model and/or lot no. and/or serial no. (Art.11-4) : **SOFT 100**
3. Intended use of the product according to the relevant harmonised technical specification : **Wood pellet-fired domestic heating appliance**
4. Name or trademark of the manufacturer (Art11-5) : **KLOVER s.r.l.**
I - 37047 San Bonifacio (VR) – Via A. Volta, 8
5. Name and address of the representative (Art.12-2) : -
6. Assessment and verification system of the performance constancy (Annex 5) : **System 3**
NB 0476
7. Notified laboratory : **KIWA CERMET ITALIA s.p.a.**
Number of test report (based on System 3) : 6002365 / C-387
8. Declared performances

HARMONISED TECHNICAL SPECIFICATION	EN 14785
PERFORMANCE FEATURES	PERFORMANCE
Fire resistance	A1
Distance from combustible material	200 mm
Fuel spillage risk	Compliant
Emission of combustion products	
- Nominal power	CO at 13% of O2 0.008 %
- Reduced power	CO at 13% of O2 0.054 %
Effective temperature	Compliant
Electrical safety	Compliant
Accessibility and cleaning	Compliant
Maximum operating pressure	-
Mechanical strength	NPD (performance not determined)
Thermal performance	
- Nominal power (reduced)	9.5 kW (2.5 kW)
- Nominal power (reduced) yielded to the environment	9.5 kW (2.5 kW)
Yield	
- Nominal power	η 92.5 %
- Reduced power	η 94.5 %
Flue gas temperature	
- Nominal power	T 122.6 °C
- Reduced power	T 60.0 °C

9. The performance of the product referred to in points 1 and 2 is compliant with the declared performance in point 8.

This declaration is released on the sole responsibility of the manufacturer referred to in point 4.

Signed in the name and on behalf of the manufacturer by:

San Bonifacio (VR), 01/08/2018

Mario Muraro

Chairman of the Board

CONTENTS

CONTENTS	1
INTRODUCTION	3
IMPORTANT SAFETY INSTRUCTIONS	3
THE MACHINE AND THE PELLETS	4
COMPONENTS OF THE APPLIANCE	4
OVERALL DIMENSIONS SOFT 80.....	6
OVERALL DIMENSIONS SOFT 100.....	7
TECHNICAL SHEET FOR SOFT 80 CONNECTIONS	8
TECHNICAL SHEET FOR SOFT 100 CONNECTIONS	9
TECHNICAL SPECIFICATIONS SOFT 80.....	10
TECHNICAL SPECIFICATIONS SOFT 100.....	11
PELLET PROPERTIES	11
REQUIREMENTS OF THE PLACE OF INSTALLATION	12
POSITIONING.....	12
SPACES AROUND AND ABOVE THE APPLIANCE.....	13
EXTERNAL AIR INTAKE	13
THE FLUE AND CONNECTION TO THE SAME.....	14
STACK.....	15
ELECTRICAL CONNECTION	16
CONNECTION TO THE ROOM THERMOSTAT.....	16
DESCRIPTION OF COMPONENTS	17
REMOTE CONTROL	17
SUPPORT PANEL	18
DISPLAY	19
THE MENU	20
INITIAL SETTINGS	26
CONNECTING THE REMOTE CONTROL	26
CONNECTION TO THE WI-FI NETWORK.....	26
COMMISSIONING	29
INITIAL START-UP.....	29
IGNITION CYCLE.....	30
WORK MODE	30
SWITCH-OFF CYCLE.....	30
MODIFYING THE MAIN ROOM TEMPERATURE SET-POINT	30
MODIFYING THE POWER SET-POINT	31
MODIFYING THE FAN AIR SPEED SET-POINT.....	31
PROBLEMS, ALARMS, USEFUL ADVICE	32
USEFUL INFO.....	32
WHAT HAPPENS IF... ..	32
ALARM SIGNALS	33
CLEANING AND MAINTENANCE	34
PRECAUTIONS BEFORE CLEANING	34
ROUTINE CLEANING	34
NON-ROUTINE CLEANING	37
ANNUAL CLEANING	38

CLEANING THE VERMICULITE COMPONENTS	42
CLEANING THE GLASS-CERAMIC PANEL	43
CLEANING THE FLUE	43
MAINTENANCE	43
PCB PARAMETERS	44
PARAMETER TABLES SOFT 80	44
PARAMETER TABLES SOFT 100	46
WIRING DIAGRAM.....	48
STANDARD WARRANTY CONDITIONS.....	49

Dear Customer,
 first of all, we would like to thank you for choosing a “KLOVER” product and hope that you will be fully satisfied with your purchase.

Carefully read the warranty certificate on the last page of this *User guide*.

The manual contains a detailed description of the appliance and its operation, instructions for proper installation, basic maintenance and points for inspection, which must be periodically carried out; furthermore, it contains useful advice on how to maximise the appliance’s performance with minimum fuel consumption.

Stay warm with KLOVER!

Copyright

All rights reserved. The reproduction of any part of this manual, in any form, without the explicit written permission of KLOVER S.r.l. is forbidden. The contents of this manual may be modified without prior notice. Although the documentation contained in this manual has been carefully compiled and checked, KLOVER S.r.l. cannot be held liable for any damages arising from the use of the same.

Copyright © 2018 KLOVER S.r.l.

INTRODUCTION

Important safety instructions

Please read these instructions before installing and using the product.

- The appliance's installation and initial start-up must be performed by skilled personnel trained in the relevant safety standards, who are responsible for the definitive installation of the appliance and its efficient operation. KLOVER S.r.l. shall not be held liable if these precautions are not observed.
- During the installation and use of the appliance, all local regulations – including those referring to national and European standards – must be observed.
- Connect the product's flue gas outlet to a flue having the specifications described in the "Flue and its connection" section of this User Guide.
- The appliance is not suitable for installation on a shared flue system.
- If the flue should catch fire, use appropriate fire extinguishing equipment or call the fire brigade.
- Connect the product to an earthed power socket. Avoid using sockets controlled by switches or automatic timers.
- Do not use the power supply cable if damaged or worn.
- If a multiple socket is used, make sure that the total voltage of the connected devices does not exceed the rated voltage for the socket. Moreover, make sure that the total voltage of all devices connected to the socket does not exceed the maximum allowed level.
- The plug on the appliance's power cable should be connected only once the appliance has been assembled and installed. It should remain accessible after the installation, if the appliance is not fitted with a suitable and accessible two-pole switch.
- Do not use highly flammable substances to clean the appliance or its parts.
- Do not leave flammable containers and substances in the place where the appliance is installed.
- The appliance works exclusively with wood pellets and only with the hearth door shut.
- NEVER open the door of the appliance during normal operation.
- The use of poor quality pellets or any other material can damage the appliance's operation, voiding the warranty and exempting the manufacturer from all liability.
- Do not use the appliance as an incinerator or for any use other than that for which it was designed.
- Do not use fuels other than those recommended.
- Do not use liquid fuels.
- The appliance becomes very hot to the touch during operation, particularly its outer surfaces; handle it with caution in order to avoid burns.
- Keep fuel and flammable materials at a safe distance.
- Only use original spare parts recommended by the manufacturer.
- Do not make any unauthorised modifications to the appliance.
- Do not touch the product's hot components (glass-ceramic panel, flue pipe) during normal operation.
- Never touch the appliance when barefoot and/or with wet or damp parts of the body.
- Use the appropriate button to switch off the electrical panel. Do not disconnect the power supply cable while the appliance is operating.
- During the ignition phase and normal operation of the appliance, keep at a safe distance and do not remain standing in front of it.
- Keep children away from the appliance when it is running, as they could get burned by touching its hot components.
- Do not leave the packaging elements within reach of children or unassisted disabled persons.
- Children and inexperienced people must not be allowed to use the appliance.
- The appliance may be used by children aged 8 years and older and by people with reduced physical, sensory or mental capabilities, or who lack the necessary experience or knowledge of the appliance, provided that they are supervised or have been instructed on how to use the appliance safely and are aware of the attendant risks.
- Children should not play with the appliance.
- User maintenance and cleaning operations should not be carried out by unsupervised children.
- Do not use the appliance in ways other than those indicated in this user guide.
- The appliance is designed for indoor use only.
- This user guide constitutes an integral part of the appliance. If the product is sold to another user, this manual must be passed on to the new owner.

KLOVER S.R.L. DECLINES ALL LIABILITY IN CASE OF ACCIDENTS DUE TO FAILURE TO COMPLY WITH THE SPECIFICATIONS OF THIS MANUAL.

KLOVER S.R.L. DECLINES ALL LIABILITY DUE TO INCORRECT USE OF THE PRODUCT BY THE USER, UNAUTHORISED MODIFICATION AND/OR REPAIRS, AND USE OF NON-ORIGINAL SPARE PARTS OR SPARE PARTS NOT SPECIFICALLY DESIGNED FOR USE ON THIS PRODUCT MODEL.

KLOVER S.R.L. SHALL NOT BE HELD LIABLE FOR THE STOVE'S INSTALLATION. THE INSTALLER IS THE SOLE PARTY RESPONSIBLE FOR THIS OPERATION AND IS ALSO ENTRUSTED WITH CHECKING THE FLUE, EXTERNAL AIR VENT AND THE CORRECTNESS OF THE PROPOSED INSTALLATION SOLUTIONS. ALL THE SAFETY REGULATIONS SET OUT IN THE SPECIFIC LAWS IN FORCE IN THE COUNTRY WHERE THE MACHINE IS INSTALLED MUST BE OBSERVED.

NON-ROUTINE MAINTENANCE MUST ONLY BE PERFORMED BY AUTHORISED AND QUALIFIED STAFF.

To ensure the validity of the warranty, the user must comply with the instructions contained in this guide and, in particular, must:

- Use the appliance within its operating limits;
- Regularly perform all maintenance activities;
- Authorise expert and competent people to use the appliance.

Failure to comply with the instructions contained in this guide shall automatically void the warranty.

THE MACHINE AND THE PELLETS

Components of the appliance

The appliance is supplied with the following material:

- 1 User, installation and maintenance manual;
- 1 Power supply cable;
- 1 Cleaning hook for the front heat exchanger;
- 1 Remote control.

The images below show certain details of the appliance:

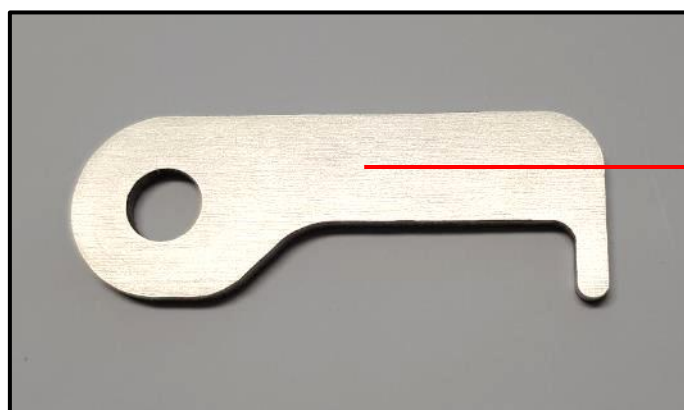

Hook for cleaning the front heat exchanger.

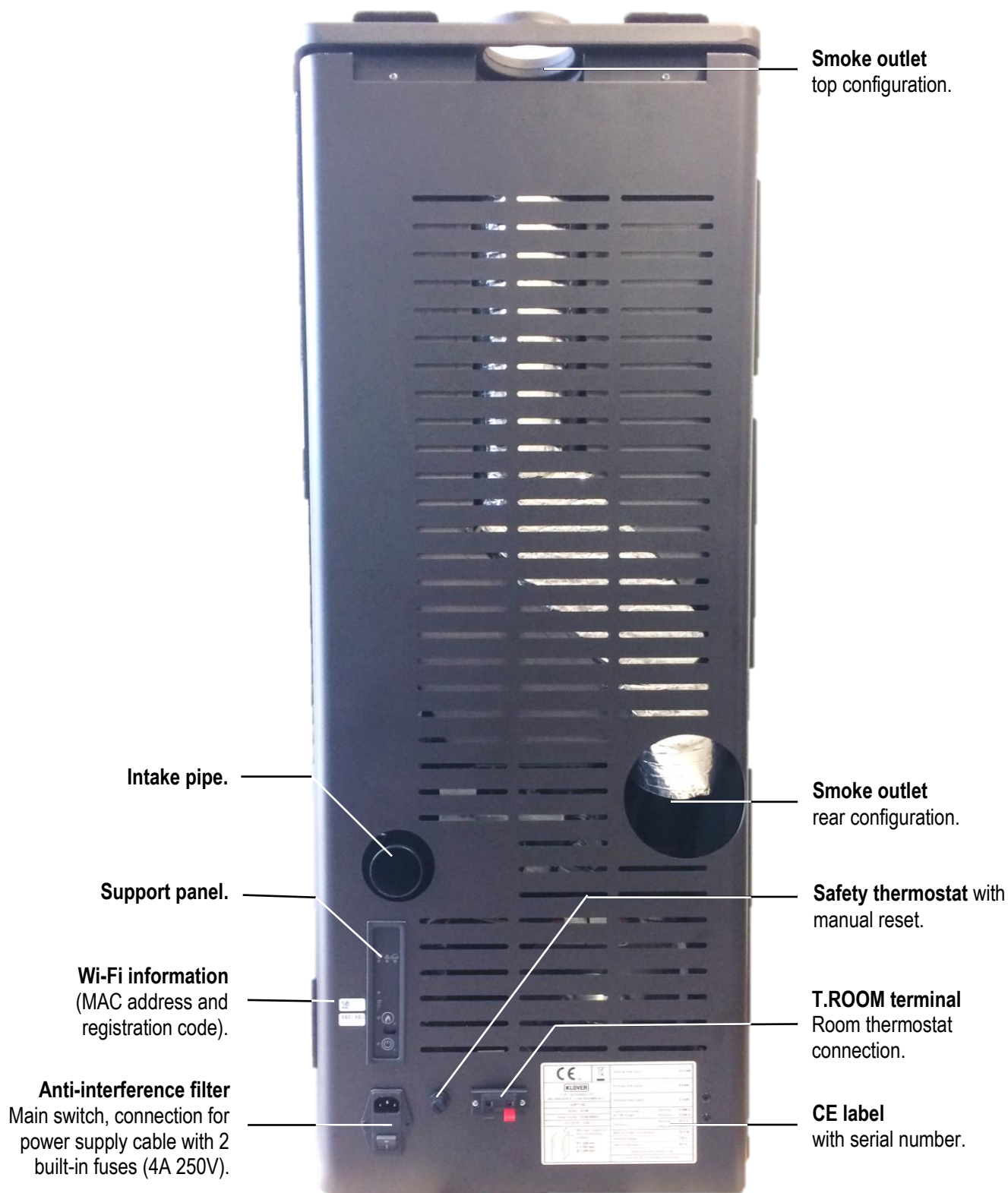

Overall dimensions SOFT 80

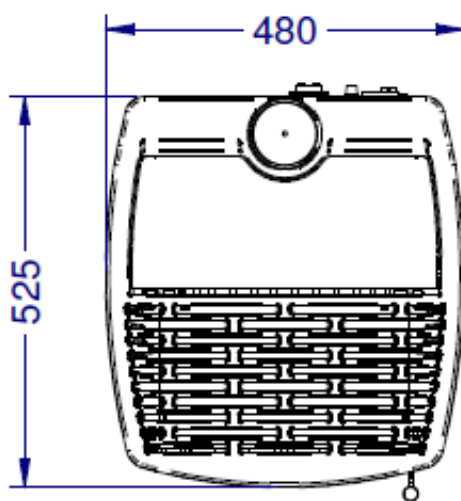
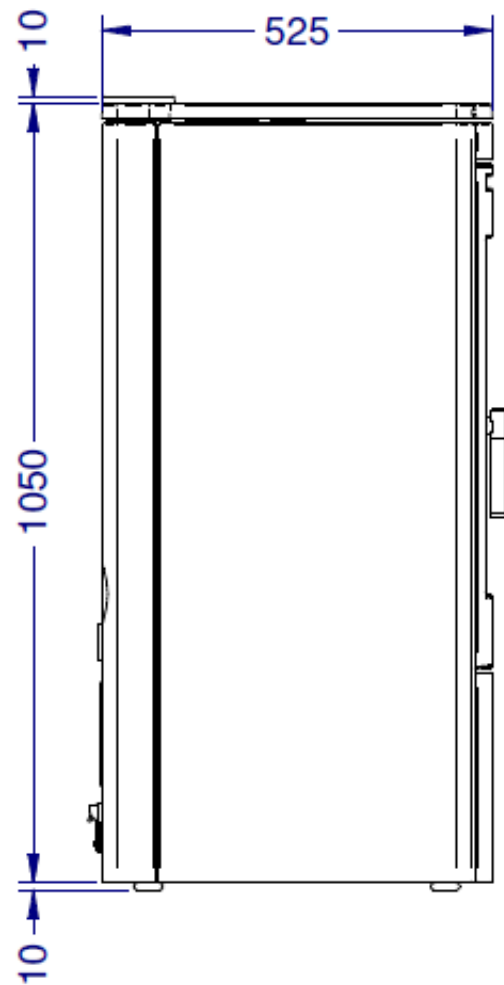
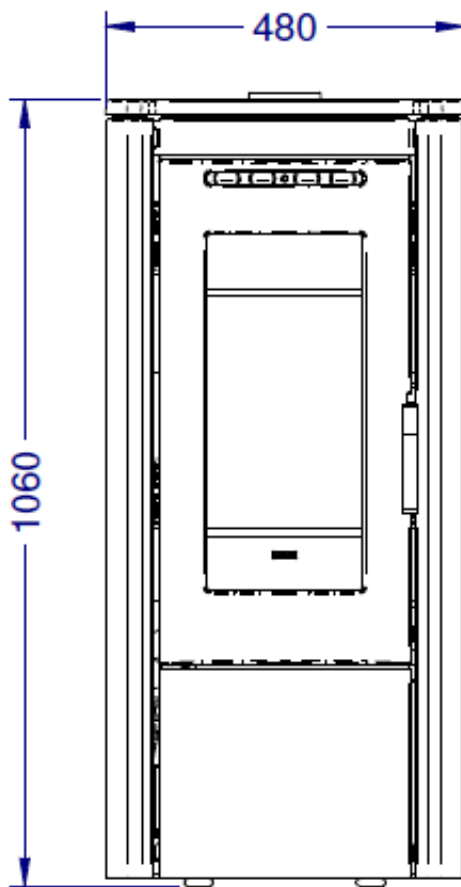

Overall dimensions SOFT 100

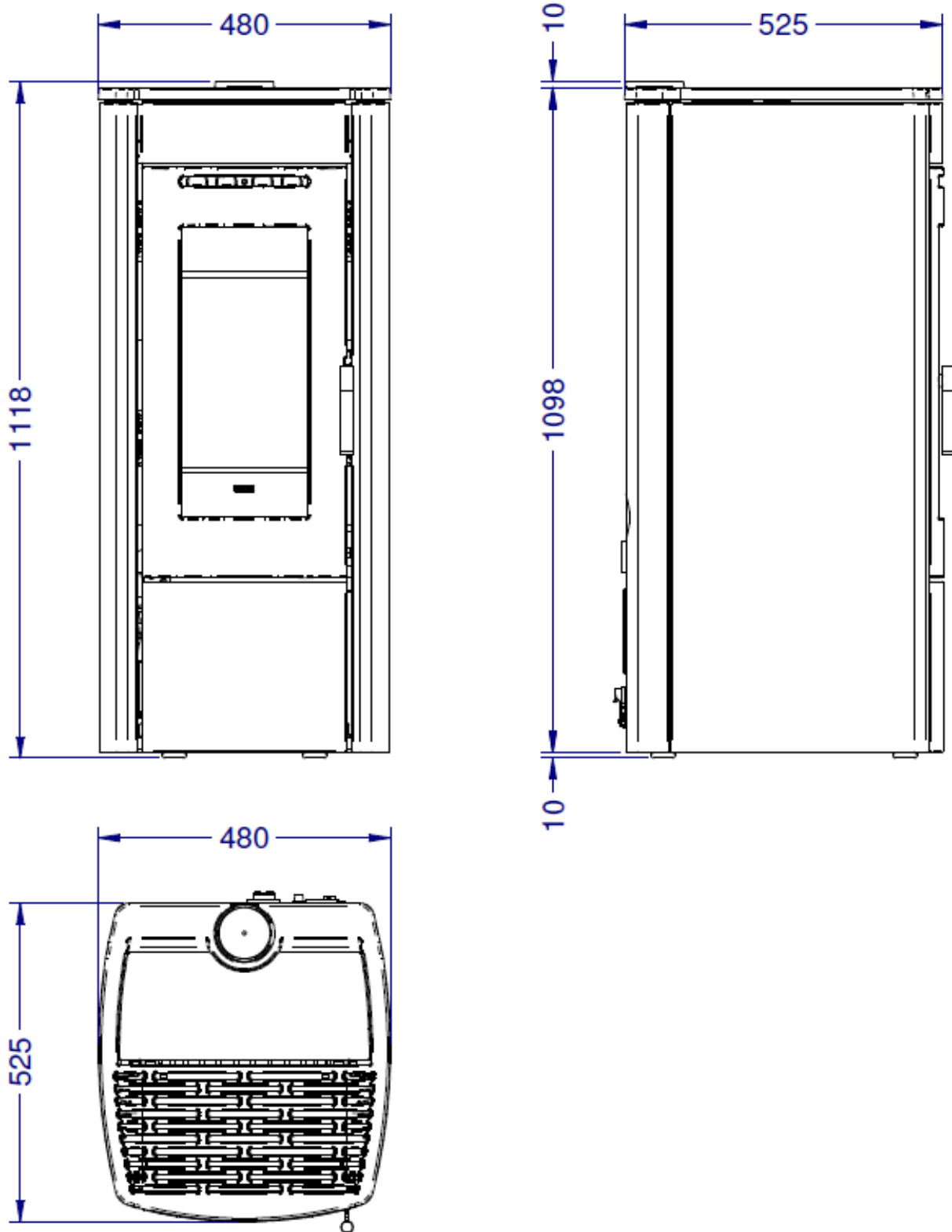

Technical sheet for SOFT 80 connections

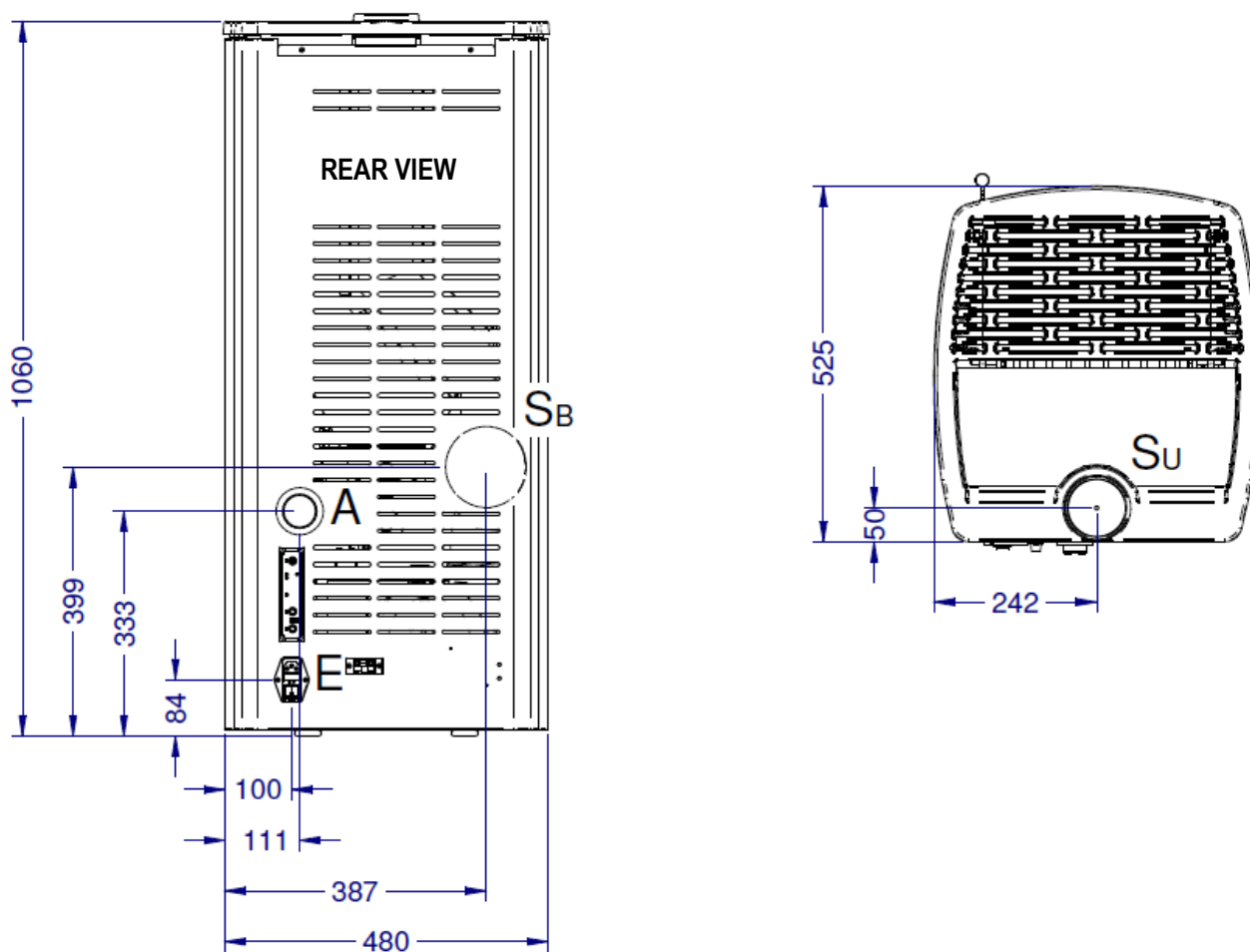

Description of connections

A = Intake pipe	50 mm
S _b = Rear flue gas outlet	80 mm M
S _u = Upper flue gas outlet	80 mm M
E = Electricity connection	

Technical sheet for SOFT 100 connections

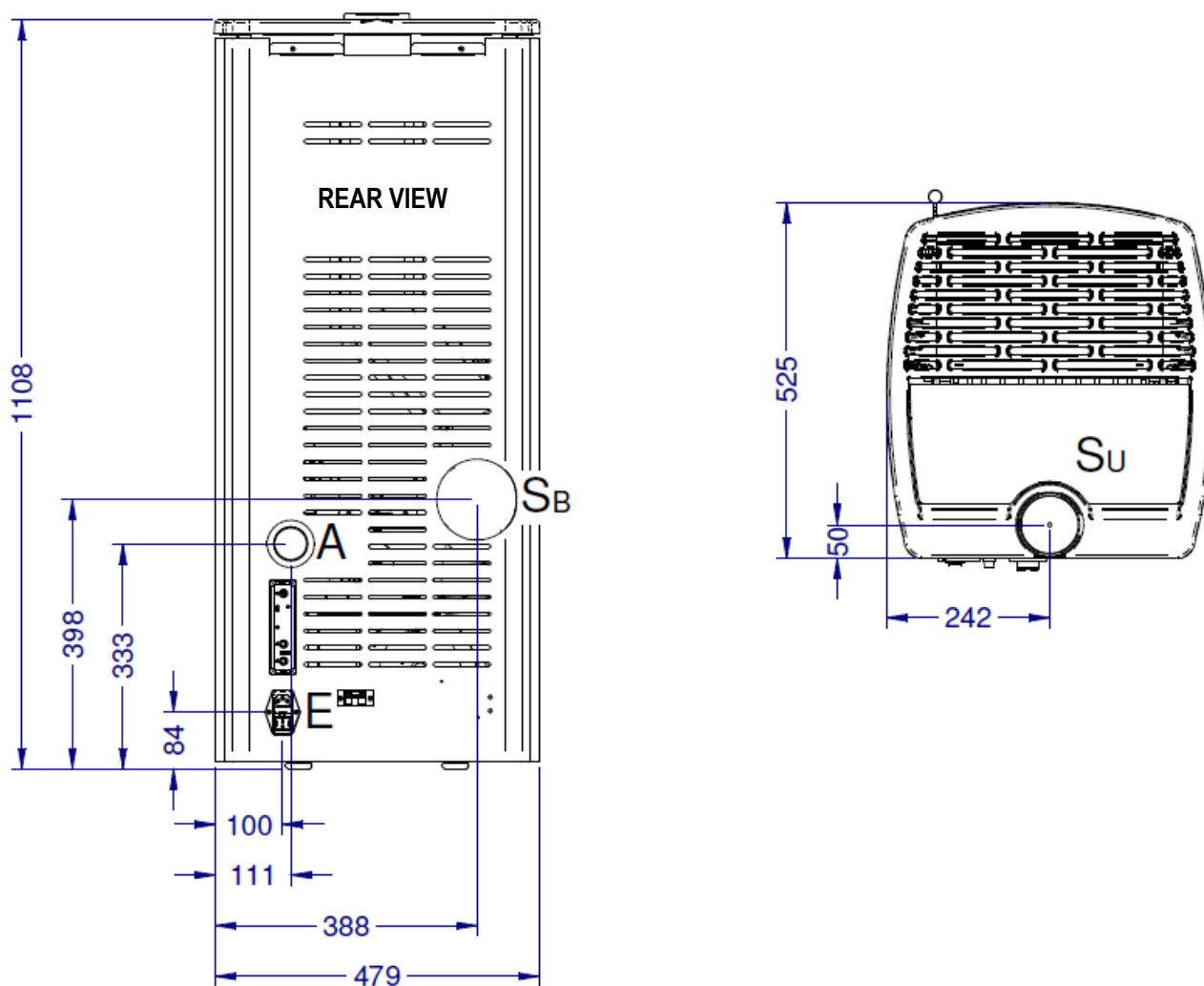

Description of connections

A = Intake pipe	50 mm
S_b = Rear flue gas outlet	80 mm M
S_u = Upper flue gas outlet	80 mm M
E = Electricity connection	

Technical specifications SOFT 80

Nominal heat input	kW (Kcal/h)	8,01 (6.889)
Reduced heat input	kW (Kcal/h)	2,70 (2.322)
Nominal heat output	kW (Kcal/h)	7,41 (6.373)
Reduced heat output	kW (Kcal/h)	2,55 (2.193)
Efficiency at nominal heat output	%	92,5
Efficiency at reduced heat output	%	94,5
CO at 13% oxygen at nominal heat output	%	0,012
CO at 13% oxygen at reduced heat output	%	0,054
Maximum power uptake	Watt	340*
Power uptake when running	Watt	30
Nominal voltage	V	230
Nominal frequency	Hz	50
Flue outlet diameter	mm	80
Air intake pipe diameter	mm	40
Minimum chimney draught at nominal heat output	Pa	10,4
Minimum chimney draught at reduced heat output	Pa	9,8
Combustion gas mass at nominal heat output	g/s	5,6
Combustion gas mass at reduced heat output	g/s	3,5
Pellet tank capacity	kg	20
Average exhaust flue gas temperature at nominal heat output	°C	115
Average exhaust flue gas temperature at reduced heat output	°C	60
Width	mm	480
Height	mm	1050
Depth	mm	525
Minimum safety distance from flammable materials (side/rear/front)	mm	200 / 200 / 800
Weight	kg	145

* Power consumption only during the ignition cycle.

The appliance's heat output may vary in relation to the type of pellets used.

Technical specifications SOFT 100

Nominal heat input	kW (Kcal/h)	10,3 (8.858)
Reduced heat input	kW (Kcal/h)	2,7 (2.322)
Nominal heat output	kW (Kcal/h)	9,56 (8.222)
Reduced heat output	kW (Kcal/h)	2,55 (2.193)
Efficiency at nominal heat output	%	92,5
Efficiency at reduced heat output	%	94,5
CO at 13% oxygen at nominal heat output	%	0,008
CO at 13% oxygen at reduced heat output	%	0,054
Maximum power uptake	Watt	340*
Power uptake when running	Watt	32
Nominal voltage	V	230
Nominal frequency	Hz	50
Flue outlet diameter	mm	80
Air intake pipe diameter	mm	50
Minimum chimney draught at nominal heat output	Pa	10,6
Minimum chimney draught at reduced heat output	Pa	9,8
Combustion gas mass at nominal heat output	g/s	6,6
Combustion gas mass at reduced heat output	g/s	3,5
Pellet tank capacity	kg	24
Average exhaust flue gas temperature at nominal heat output	°C	122
Average exhaust flue gas temperature at reduced heat output	°C	60
Width	mm	480
Height	mm	1100
Depth	mm	525
Minimum safety distance from flammable materials (side/rear/front)	mm	200 / 200 / 800
Weight	kg	155

* Power consumption only during the ignition cycle.

The appliance's heat output may vary in relation to the type of pellets used.

Pellet properties

The appliance has been tested with all types of pellets available on the market. The pellets must have the following properties:

- Diameter 6 mm.
- Maximum length 35 mm.
- Maximum humidity content 8–9 %.
- Made of 100% wood. Totally additive-free.
- Maximum ash residue 1.1 %.

To obtain optimal efficiency from the appliance, we recommend using good quality pellets. **Pellets should be poured into the tank using a shovel, and not directly from the bag.**

Good quality pellets should have the following properties:

- Constant-diameter cylinders with a smooth, shiny surface;
- Low amount of sawdust inside the packages;
- After grabbing a bunch of pellets and placing them into a container filled with water, good quality pellets will sink and poor quality ones will tend to float;
- The quality certification data, in particular conformity to international standards such as EN14961-2, DIN 51731 and O-NORM M7135, should be indicated on the packaging;
- The packages should be intact since pellets tend to absorb humidity. Humidity not only reduces the calorific value and increases the amount of flue gases expelled, but also causes swelling of the product which may create problems with the appliance.

The production of pellets must comply with international standards (such as EN14961-2, DIN 51731 and O-NORM M7135) which define minimum values for checking pellet quality. To facilitate the right choice of the combustible material, we indicate below one of the most common certification marks identifying pellet quality:

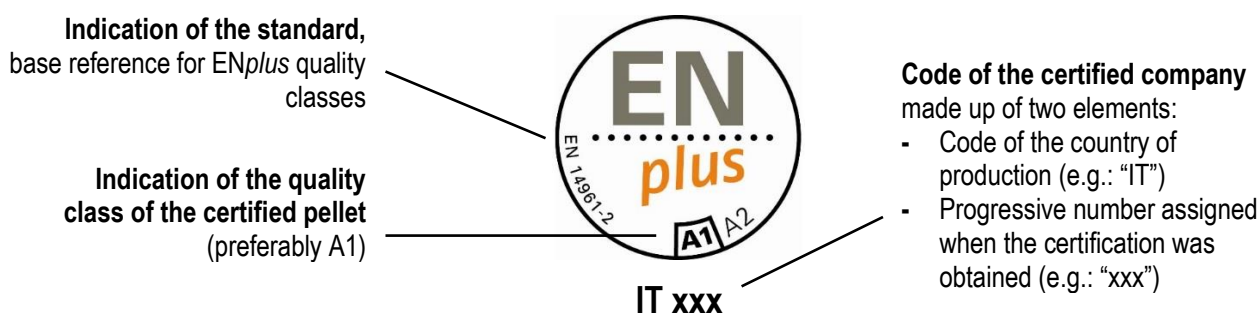

The use of poor quality pellets or any other material can damage the appliance's operation, voiding the warranty and exempting the manufacturer from all liability.

In order to guarantee trouble-free combustion, the pellets must be stored in a dry place.

REQUIREMENTS OF THE PLACE OF INSTALLATION

Positioning

The initial phase for best installation of the appliance is to determine its optimum location; the following elements need to be considered:

- The possibility of creating an external air vent;
- The possibility of creating a straight flue, preferably coaxial to the outlet of the appliance;
- Ease of access for cleaning the appliance, the flue gas exhaust pipes and the flue.

The unit must be installed on a floor with a suitable load capacity. If the existing building does not fulfil this requirement appropriate measures (e.g. load distribution plate) must be taken.

The minimum safety distance from flammable materials must be at least 200 mm from the sides and 800 mm from the front of the appliance.

Relocating the appliance should not be done by forcing on the handle, glass or ceramics.

The installation must guarantee easy access for cleaning the appliance, the flue gas exhaust pipes and the flue, and any subsequent maintenance operation by the Authorised technical assistance centre.

Once you have found the best location for the appliance, position it following the instructions given below.

The appliance must not be installed in small rooms, bedrooms, bathrooms or in areas with an explosive atmosphere.

Spaces around and above the appliance

The figure below shows the minimum distances from walls or other not-easily-removable furniture, that need to be taken into consideration when positioning the appliance.

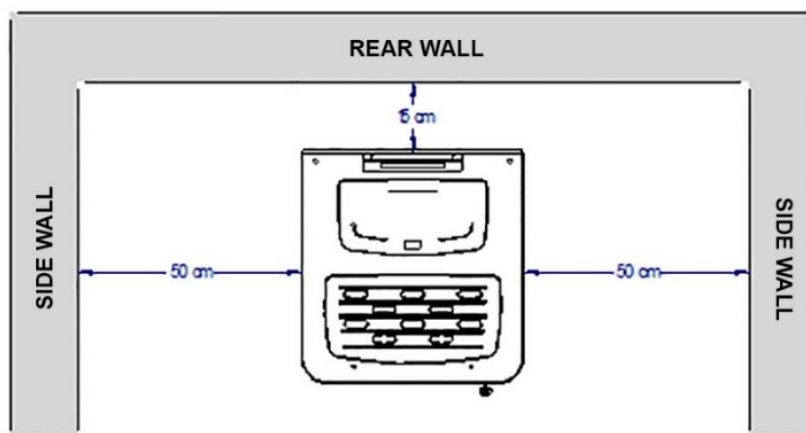

Any shelves or false ceilings mounted above the appliance must be at least 150 cm away from the top part of it. Furniture and movable objects made from flammable materials must be positioned at least 50 cm from the side surfaces of the appliance; these objects must be moved when performing maintenance on the appliance. Protect all structures that can catch fire against the radiated heat of the fire.

External air intake

During operation, the appliance takes in air from the environment in which it is installed; It is therefore essential that this air is replaced through an external air vent. The absence of the air vent may affect the flue draught and therefore the combustion and the safety of the appliance.

Therefore **it is mandatory** to install an external air vent with a minimum completely free passage of **at least 80 cm²** (round hole with minimum diameter of 15 cm protected with a special fixed large mesh grid).

If the wall behind the appliance is on the outside, we recommend you make the hole near it at about 20 cm above the ground (see example in Fig. A).

If it is not possible to put an air vent in the wall behind the appliance, make a hole in a perimeter wall in the room where it is installed. If it not possible to put the external air vent in the same room as where the appliance is installed, this hole can be made in an adjoining room as long as this room communicates permanently, by means of a transit hole (15 cm minimum diameter).

The hole must be protected externally with a fixed grille. The protective grille must be checked periodically to ensure that it is not obstructed, thereby impeding the passage of air. **Therefore keep the air vents clear of obstructions.**

The UNI 10683 Standard FORBIDS the drawing of combustion air from garages, warehouses storing combustible materials, or from business premises with a fire hazard.

If there are other heating or extraction devices inside the room, the air vents must guarantee a sufficient amount of air for properly operating all the devices.

Only sealed appliances (e.g. C type gas appliances, according to the UNI 7129 Standard) or appliances that do not cause a lower pressure compared with the external environment can pre-exist or be installed in the place where the appliance is installed.

Extractor fans can cause malfunctions to the appliance if used in the same room.

Do not connect the external air vent directly to the appliance through piping. If there are other heating or extraction devices inside the room, the air vents must guarantee a sufficient amount of air for properly operating all the devices.

Only sealed appliances or appliances that do not cause a lower pressure compared with the external environment can pre-exist or be installed in the place where the appliance is installed.

Extractor fans can cause malfunctions to the appliance if used in the same room.

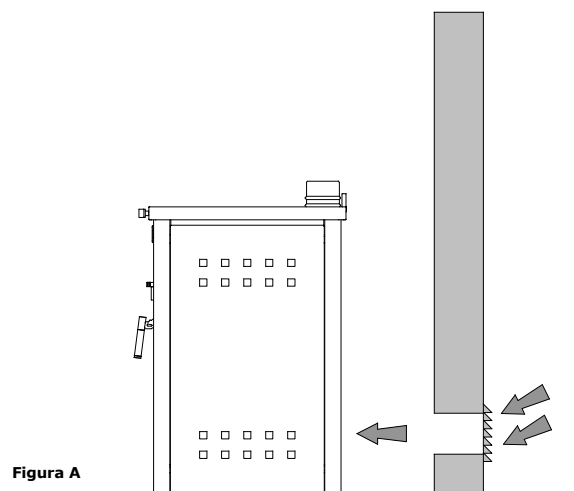

Chimney and Flue pipe

The chimney is essential to the efficient operation of a Klover appliance. The chimney should be designed and constructed according to these instructions, and relevant regulations including Building Regulations Approved Document J.

Shape and size of chimney: A round chimney of 125mm diameter is recommended. 125mm is also the minimum diameter which should be used. If the appliance is DEFRA Exempt then it should be connected to a 125mm chimney as standard (assuming that the outlet is not larger than 125mm). If it is not DEFRA Exempt then a calculation according to BS EN 13384-1:2002 must be completed if it is to be connected to a 125mm diameter chimney.

The maximum recommended round chimney diameter is 150mm.

Square or rectangular cross-sections must have rounded corners with radius not less than 20 mm. Rectangular cross-sections must have a maximum ratio of 1.5 between the sides.

The chimney must have a constant, and unobstructed, internal cross section.

Under no circumstances should the chimney be of a smaller diameter than the appliance outlet.

Connecting flue pipe: Short runs of single skin flue pipe to connect to the chimney may be run in a (minimum) diameter of 100mm (as long as this is not smaller than the appliance outlet).

Existing chimneys: Existing masonry chimneys should be lined with flexible stainless steel liner and the liner should be insulated. All connections must be appropriately sealed.

Existing chimneys must be inspected, be clear of obstruction and have been swept clean immediately before installation of the lining system.

No shared chimneys: Each appliance must connect to its own flue. No other appliance must connect to the same flue or chimney. No other pipes or conduits must pass through the chimney or flue.

Sealed joints and connections: The appliance works with the combustion chamber in negative pressure and the flue pipe under positive pressure; it is essential that all joints and flue and chimney connections are sealed. Single skin and twin wall flue pipe should incorporate silicone seals at each joint. Other connections should be sealed with a suitable sealant (for example high temperature silicone). All seals must be able to withstand 250°C or more.

Suitable materials: Flue and chimney products used, including fixings and components, must be made of suitable, non-combustible materials conforming to the applicable regulations.

Aluminium and fibre cement pipes are forbidden.

Orientation and initial vertical rise: The flue system should run as vertically as possible as any deviations off the vertical can adversely affect the draw. 45° is the maximum off-vertical angle than may be used. Non-vertical sections should make up no more than ¼ of the effective height of the flue or chimney (measured from the appliance outlet to the top of the chimney), and must not be longer than 2,000 mm.

There should be no more than 4 bends in the system, with a tee counting as 2 bends.

Securely fix and support the system to avoid vibration and movement.

90° bends should not be used. When using the rear outlet on the appliance a 90° tee should be used with sweeping access and debris collection space.

When using the rear outlet any horizontal run should not exceed 150mm, including the arm of the tee.

An initial vertical run of 600mm from the appliance is recommended before any change in direction.

Cleaning Access: The system must provide access so that the entire system can be swept and cleaned.

Flue pipes must not pass through rooms in which the installation of combustion devices is prohibited.

IT IS STRICTLY FORBIDDEN TO INSTALL FLUE DAMPERS/BUTTERFLY VALVES.

Heat shielding: If combustible materials are present then minimum separation distances will need to be adhered or heat shielding will be required. Please refer to Building Regulations Approved Document J, and also these installation instructions.

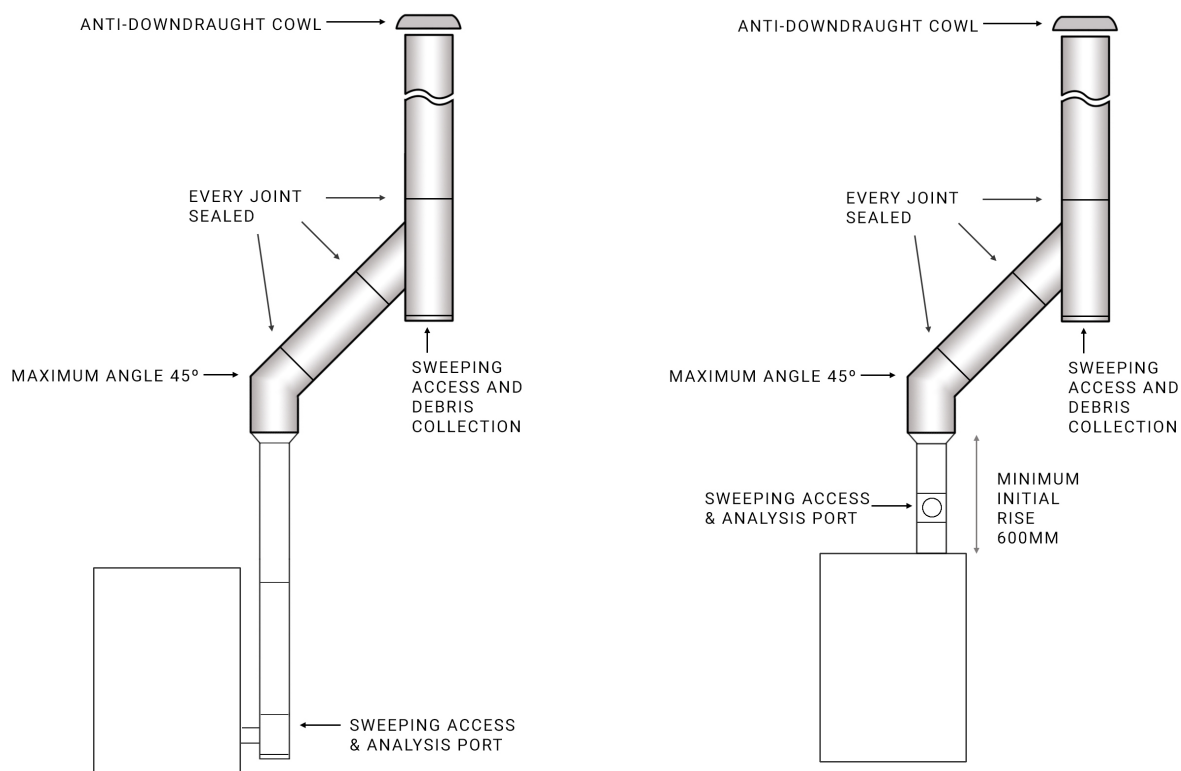

Height and draught: In order for the appliance to perform satisfactorily the chimney height must be sufficient to ensure a draught of 12 Pa so as to clear the products of combustion and prevent smoke problems into the room. A chimney height of not less than 4.5 m measured vertically from the outlet of the stove to the top of the chimney should be satisfactory. Alternatively the calculation procedure given in BS EN 13384-1:2002 may be used as the basis for deciding whether a particular chimney design will provide sufficient draught.

The outlet from the chimney should be above the roof of the building in accordance with the provisions of Building Regulations Approved Document J diagram 17 or 18. Please see the diagram below.

Point where flue passes through weather surface (Notes 1, 2)	Clearances to flue outlet
A At or within 600mm of the ridge	At least 600mm above the ridge
B Elsewhere on a roof (whether pitched or flat)	At least 2300mm horizontally from the nearest point on the weather surface and: a) at least 1000mm above the highest point of intersection of the chimney and the weather surface; or b) at least as high as the ridge.
C Below (on a pitched roof) or within 2300mm horizontally to an openable rooflight, dormer window or other opening (Note 3)	At least 1000mm above the top of the opening.
D Within 2300mm of an adjoining or adjacent building, whether or not beyond the boundary (Note 3)	At least 600mm above any part of the adjacent building within 2300mm.
Notes 1) The weather surface is the building external surface, such as its roof, tiles or external walls. 2) A flat roof has a pitch less than 10°. 3) The clearances given for A or B, as appropriate, will also apply. 4) A vertical flue fixed to an outside wall should be treated as equivalent to an inside flue emerging at the nearest edge of the roof.	

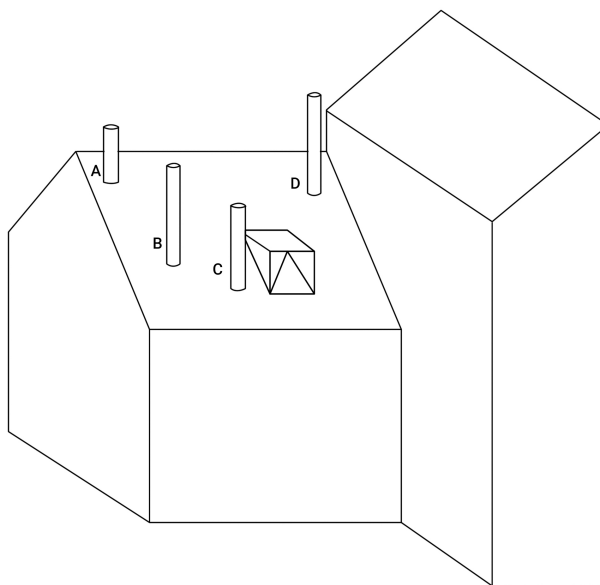

Termination/Cowl: The cowl terminates the chimney and it is recommended that an effective anti-downdraft cowl should always be used. It must have a usable outlet cross-section no less than double that of the flue onto which it is inserted. It must prevent rainwater or snow entry. It must ensure the discharge of combustion by-products even in the event of winds from every direction and inclination.

ELECTRICAL CONNECTION

The electric connection must only be performed by **qualified staff**, in compliance with all general and local safety regulations.

Check that the power supply voltage and frequency correspond to 220 V – 50 Hz.

The appliance's safety is ensured when it is properly connected to an efficient earthing system.

When making the electric connection to the mains power supply, include a 6 A – Id 30 mA magnetothermic residual-current device with suitable breaking load. The electric connections, including the earth connection, must be made after shutting off the electrical system.

When completing the system, bear in mind that the cables must be laid in an unmovable manner and far from parts subject to high temperatures. During the final wiring of the circuit, only use components with a suitable electrical protection rating. Do not pass electrical cables in the immediate vicinity of the flue gas pipe, unless they are insulated with suitable materials.

KLOVER S.r.l. declines all responsibility for injury to persons and animals or damage to objects due to failure to earth the appliance or to comply with IEC specifications.

Connection to the room thermostat

One or more terminal blocks are located behind the appliance to connect any room thermostats (*refer to "Components of the appliance"*).

The table below describes the operation of the terminal blocks found on the rear panel of the appliance.

<i>Terminal block</i>	<i>Description</i>	<i>Type of management</i>	<i>Action</i>
1	Main room	Only with room thermostat *	<p>With the contact CLOSED, the appliance continues to work at the set power, regardless of the SET ROOM (button 1) value and the status of any other room thermostats or probes connected.</p> <p>With the contact OPEN, the appliance enters the modulation mode, provided that the room temperature set in SET ROOM (button 1) is fulfilled and that any other room thermostats or probes connected are fulfilled.</p>

* Connect a non-powered room thermostat to manage a simple dry contact and, preferably, with a settable hysteresis value.

DESCRIPTION OF COMPONENTS

Remote control

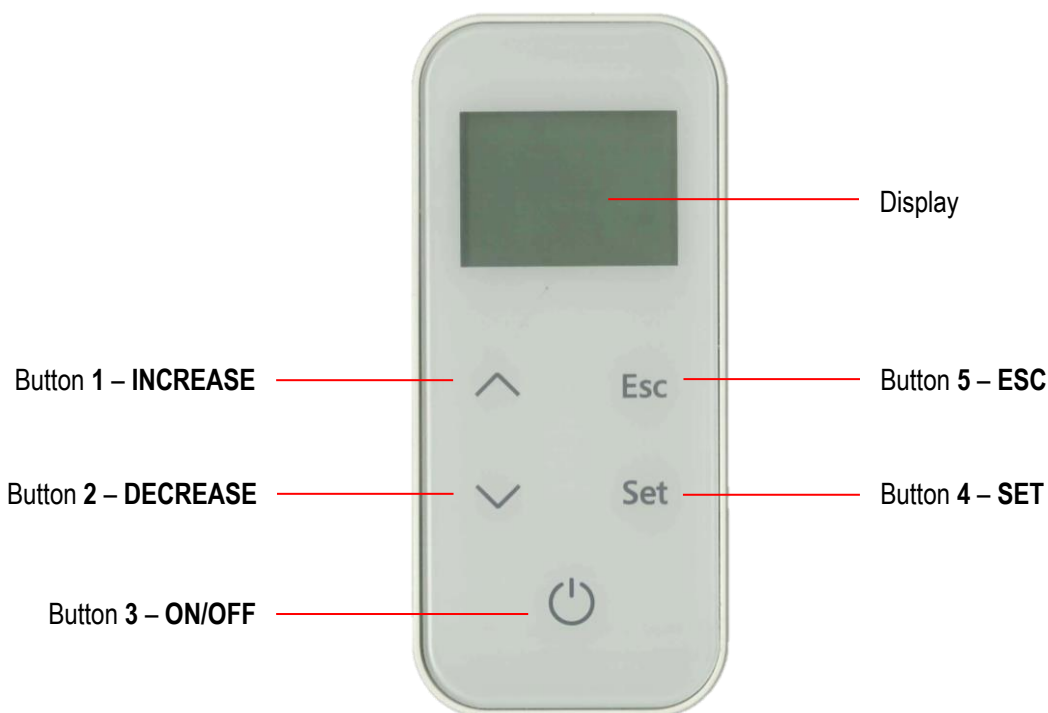

The remote control must be powered by 3 x 1.5 V AAA batteries (model LR03 / MN2400); the battery life depends on how frequently the remote control is used.

The table describes the operation of the buttons on the remote control.

Button	Description	Mode	Action
1	INCREASE	When pressed the first time...	Allows for modifying the "SET ROOM" room temperature.
		In programming mode...	Changes/increases the value of the selected menu item. Increases the room temperature/working power value.
2	DECREASE	When pressed the first time...	Allows for modifying the "SET OUTPUT" working power.
		In programming mode...	Changes/decreases the value of the selected menu item. Decreases the room temperature/working power value. In "SET DUCTING", it modifies the value of the frontal fan.
3	ON/OFF	When pressed the first time...	It switches on the display.
		In work mode...	Switches the appliance off when pressed for 2 seconds.
		In off mode...	Switches the appliance on when pressed for 2 seconds.
		In alarm lock mode...	Disengages the alarm.
4	SET	In menu/programming mode...	Goes to the previous menu level, without saving the changes made.
		When pressed the first time...	Accesses the user menu.
		In menu mode...	Goes to the next menu, saving the changes made.
5	ESC	In programming mode...	Goes to the next sub-menu item, saving the changes made.
		When pressed the first time...	Allows for modifying the speed of the frontal fan "SET DUCTING".
		In menu mode...	Goes to the previous menu, saving the changes made.
		In programming mode...	Goes to the previous sub-menu item, storing the changes made.

Support panel

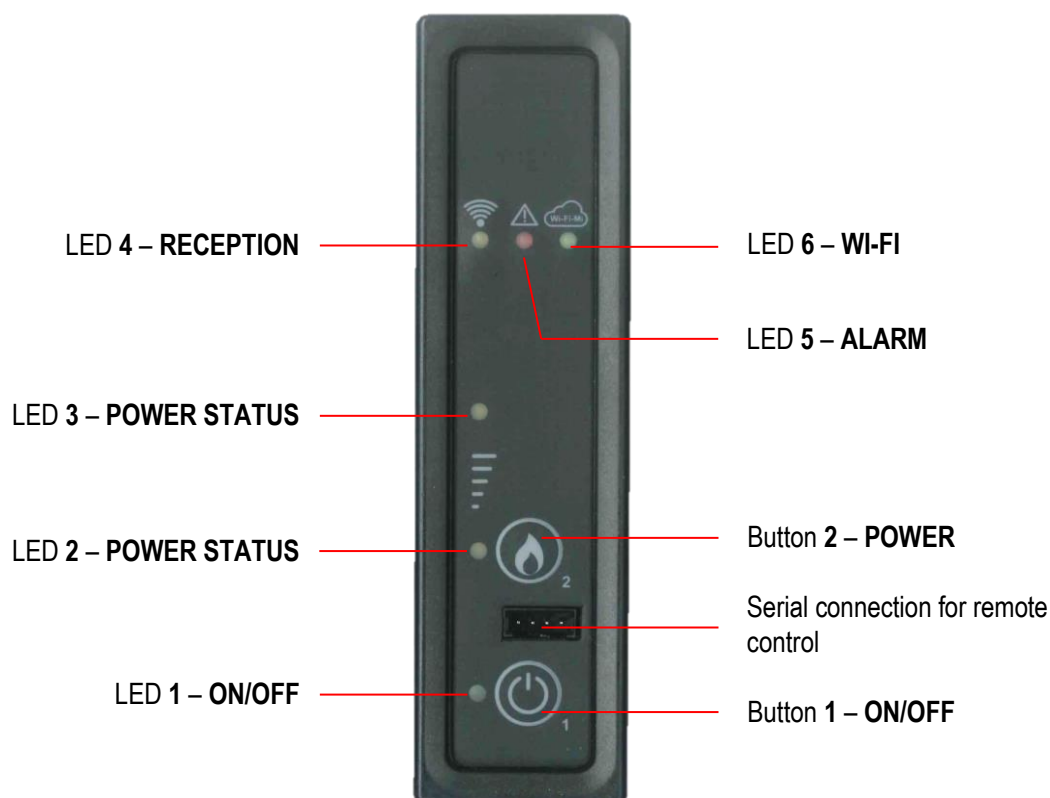

The underlying table describes the operation of the buttons on the remote control.

Button	Description	Mode	Action
1	ON/OFF	In work mode...	Switches the appliance off when pressed for 2 seconds.
		In off mode...	Switches the appliance on when pressed for 2 seconds.
		In alarm lock mode...	Disengages the alarm.
2	POWER	Whenever pressed...	Allows for modifying the "SET OUTPUT" working power, by selecting among 3 available power levels (1, 3 or 5).

The underlying table describes the operation of the LEDs present on the support panel.

LED	Description	Status	Action
1	ON/OFF	Off	The appliance is off.
		Flashing	The appliance is switching off.
		Lit	The appliance is on.
2 and 3	POWER STATUS	LED 2 Lit, LED 3 Off	Power set-point set to 1
		LED 2 Lit, LED 3 Lit	Power set-point set to 3
		LED 2 Off, LED 3 Lit	Power set-point set to 5
4	RECEPTION	Lit	Switches on when the PCB receives a signal from the remote control.
5	ALARM	Lit	The appliance is in alarm mode.
6	WI-FI	Off	The appliance is not connected to a Wi-Fi network.
		Lit	The appliance is connected to a Wi-Fi network.

The support panel allows for managing the basic functions concerning the appliance's operation when there is no remote control.

The following operations can therefore be carried out:

- **SWITCHING ON/OFF:** by pressing and holding button 1 (On/Off) for 2 seconds
- **WORKING POWER CHANGE:** whenever button 2 (Power) is pressed, the working power can be varied by selecting one of the three available power levels (1, 3 or 5). With the help of LEDs 2 and 3 (Power status), it is possible to verify which power level was chosen (see LED table).

Display

The remote control display shows information on the appliance's operating status.

The display can be switched on by pressing button 3 (On/Off).

The underlying figure shows the display during normal operating conditions.

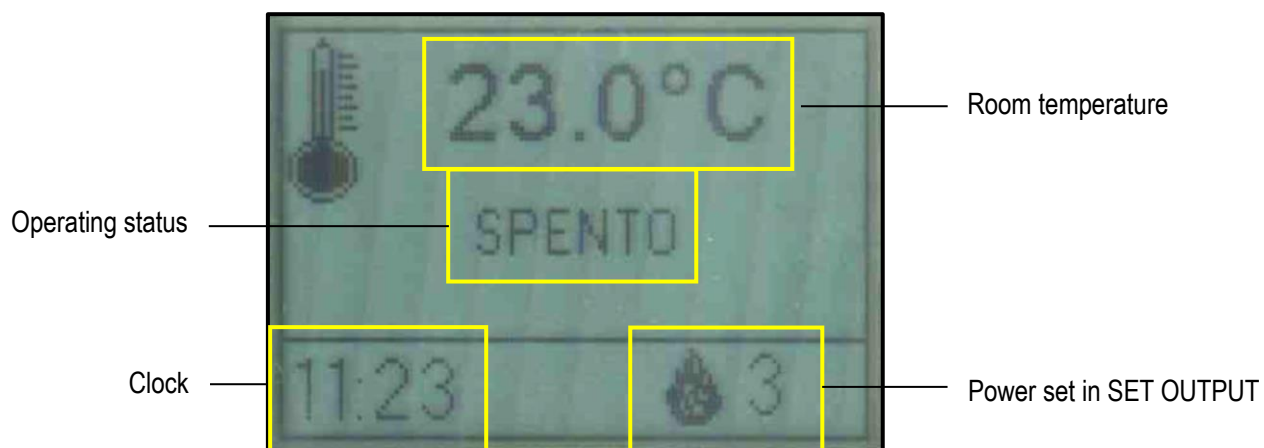

By accessing the menu through button 4 (Set), it is possible to obtain various types of display modes and perform settings according to the selected menu.

The figure below shows the display when the menus are being browsed.

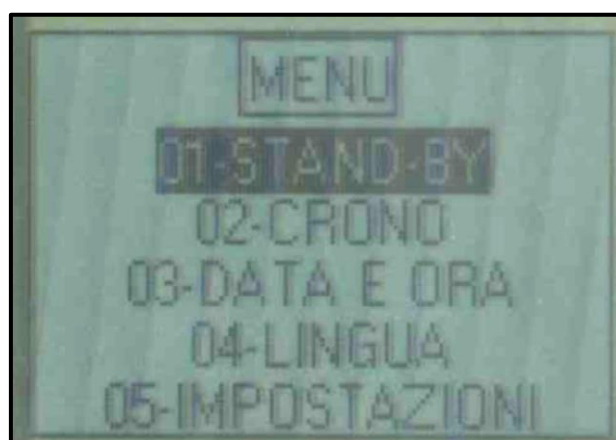

THE MENU

Pressing button 4 (Set) of the remote control allows for accessing the menu.

The menu is divided into various items and levels that allow for accessing the settings and programming options of the appliance.

Buttons 1 and 2 (Increase and Decrease) can be used to select the menu to be modified.

Button 4 (Set) can be used to access the menu to be modified, saving the changed made.

Button 5 (Set) can be used to return to the previous menu level, saving the changed made.

Inside the menus to be modified, buttons 1 and 2 (Increase and Decrease) can be used to modify the value set in the selected menu.

Listed below are the menus present on the PCB with the relevant explanations.

Menu 01 – Stand-by

If not enabled, the shutting down of the appliance is disabled even when the temperature set in “SET ROOM” is reached.

The working power will nevertheless be modulated; the word “MODULATION” will appear on the display.

If enabled, the appliance enter the modulation and/or shutdown mode once the temperature set in “SET ROOM” is reached. During the modulation phase, the wording “OK ST-BY” will appear on the display; when the appliance shuts down, “STAND-BY” appears.

The image below shows the display when STAND-BY is enabled:

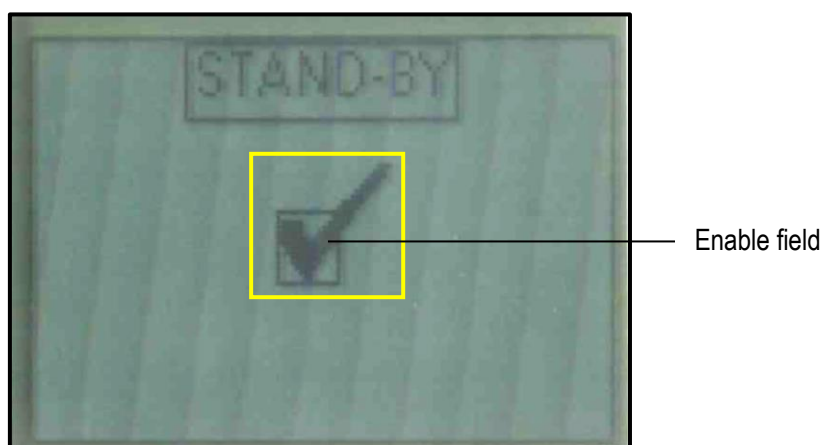

Menu 02 – Chrono

Allows for accessing the various timer programmes (daily, weekly and weekend).

In order to prevent any undesired switching on/off operations, only activate and use a single programme at a time (daily, weekly or weekend programme).

- **Sub-menu 02 – 01 – Enabl. chrono**

Allows for enabling and disabling all the timer's functions. For correct use, it should be enabled with buttons 1 or 2 (Increase and Decrease) when at least one on/off programme (daily, weekly or weekend) is enabled.

The image below shows the display when the timer is enabled:



- **Sub-menu 02 – 02 – Daily chrono**

Allows for enabling, disabling and setting the daily programme functions.

The daily timer has two time slots delimited by the set times, as shown in the following diagram (they do not have to be used simultaneously):

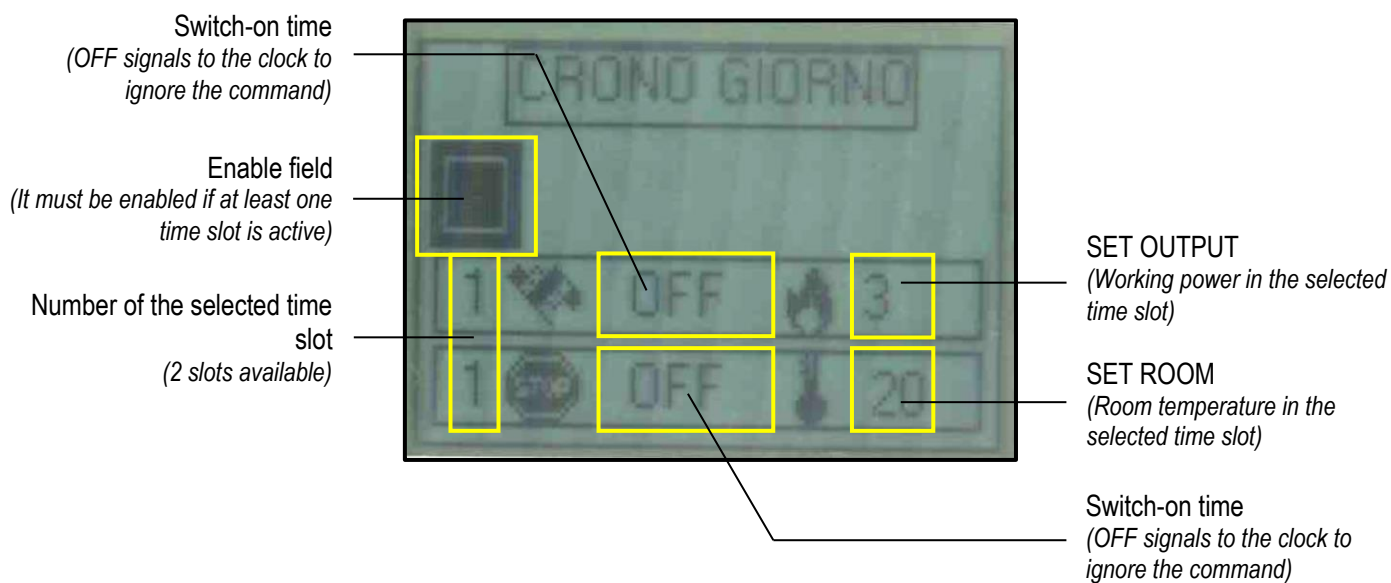

- Buttons 1 and 2 (Increase and Decrease) are used to modify the selected value.
- Button 4 (Set) is used to select the next value.
- Button 5 (Esc) is used to select the previous value.
- Button 3 (ON/OFF) is used to return to the previous menu.

• Sub-menu 02 – 03 – Weekly chrono

Allows for enabling, disabling and setting the weekly timer functions.

The weekly timer has four time slots delimited by the set times, as shown in the following diagram (they do not have to be used simultaneously):

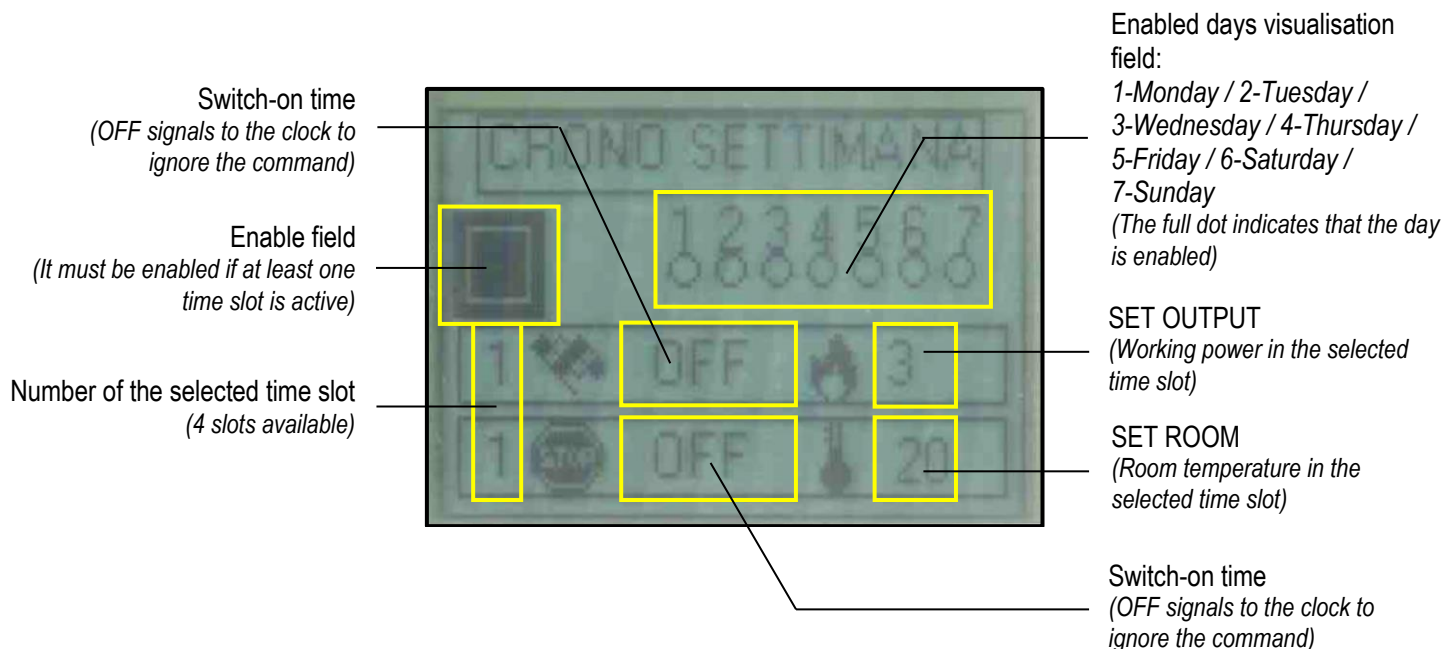

- Buttons 1 and 2 (Increase and Decrease) are used to modify the selected value.
- Button 4 (Set) is used to select the next value.
- Button 5 (Esc) is used to select the previous value.
- Button 3 (ON/OFF) is used to return to the previous menu.

After setting the switch-on/off times and the power and temperature set-points, it is necessary to select the days on which to enable the reference time slot. Shown below is the window in which the days must be enabled:

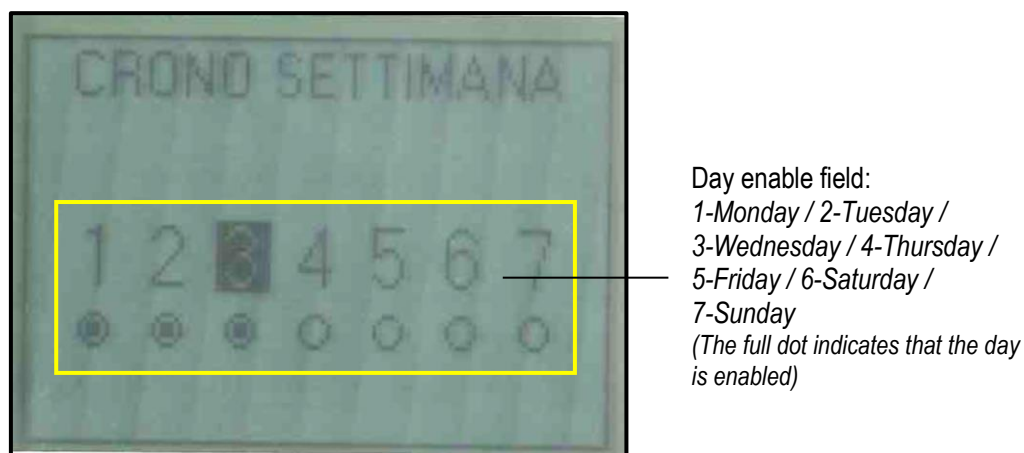

- Button 1 (Increase) is used to enable the selected day.
- Button 2 (Decrease) is used to disable the selected day.
- Button 4 (Set) is used to select the next day.
- Button 5 (Esc) is used to select the previous day.
- Button 3 (ON/OFF) is used to return to the previous menu.

• Sub-menu 02 – 04 – Week-end chrono

Allows for enabling, disabling and setting the weekend timer functions (applies to Saturday and Sunday).

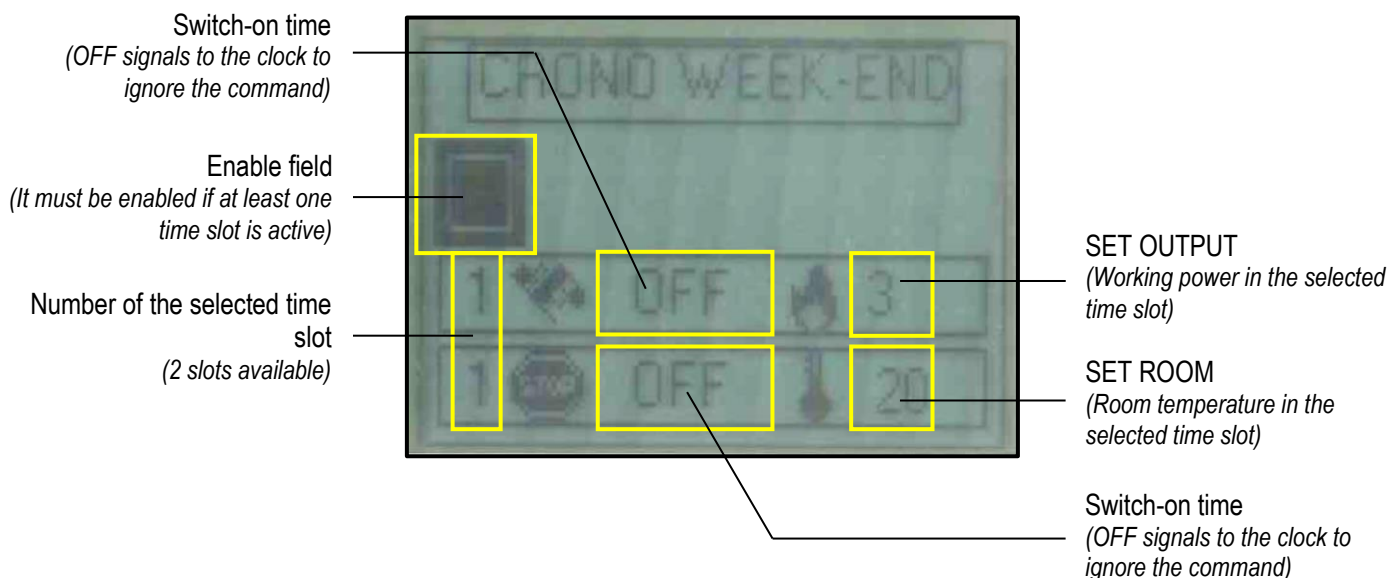

- Buttons 1 and 2 (Increase and Decrease) are used to modify the selected value.
- Button 4 (Set) is used to select the next value.
- Button 5 (Esc) is used to select the previous value.
- Button 3 (ON/OFF) is used to return to the previous menu.

Menu 03 – Set clock

It allows you to set the day, time and current date.

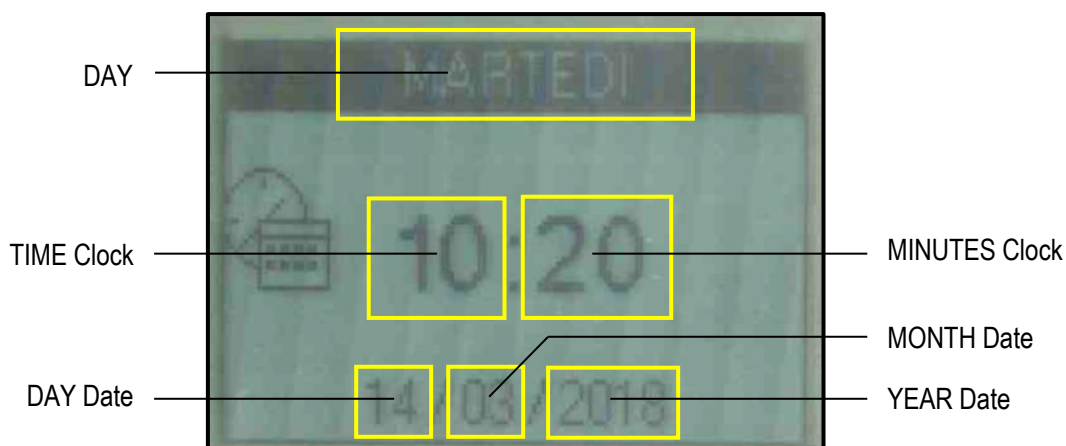

- Buttons 1 and 2 (Increase and Decrease) are used to modify the selected value.
- Button 4 (Set) is used to select the next value.
- Button 5 (Esc) is used to select the previous value.
- Button 3 (ON/OFF) is used to return to the previous menu.

Menu 04 – Language

Allows you to select the dialogue language from the available choices (Italian, English, French, German and Spanish).

Menu 05 – Settings

It allows for adjusting the various remote control settings.

The table below indicates the settings with the relevant meaning:

<i>Menu</i>	<i>Meaning</i>	<i>Settable values *</i>
BOARD BEEPS	Enables/disables the beep sound on the power PCB	ON – OFF
BACKLIGHT ON	Regulates the duration of display illumination	2 – 10 sec
DISPLAY ON	Regulates the period the display remains ON	15 – 60 sec ON
BRIGHTNESS	Enables/disables the illumination of the display	ON – OFF
CONTRAST	Regulates the contrast of the display	15 – 60 #
KEY BEEPS	Enables/disables the beeps every time the remote control keys are pressed	ON – OFF

* The settings can affect the life of the batteries in the remote control.

Menu 06 – Initial load

Enables pellet pre-loading for 90 seconds when the appliance is switched off and cold. Start the function with button 1 (Increase) and stop it with button 3 (On/Off). This may be useful if the appliance is switched on after the tank has been completely emptied, or when it is filled for the first time. **Warning: once the operation has been completed, before switching on the appliance you should empty any pellets left inside the ash box.**

Menu 07 – Stove status

It allows for viewing the instantaneous status of the appliance, with the operating conditions of the various devices connected to it. Several pages are displayed in succession. The data is reserved for Technical Assistance Centre. The table below indicates the various devices with the relevant meaning:

<i>Display wording</i>	<i>Meaning</i>
L04-270218 (example)	Code of the firmware loaded in the control unit.
AIR 1.0 (example)	Code of the firmware loaded in the remote control.
T.SMOKE	Indicates the temperature measured by the probe inside the combustion chamber.
T.ROOM	Indicates the room temperature measured by the probe on the remote control.
T.ROOM 1	Indicates the temperature in ducted room 1 as measured by the probe, if there is one connected. Indicates the status of the room thermostat, if there is one connected: (OFF = R.T. contact OPEN = Thermostat not triggered); (ON = R.T. contact CLOSED = Thermostat triggered).
T.ROOM 2	Indicates the temperature in ducted room 2 as measured by the probe, if there is one connected. Indicates the status of the room thermostat, if there is one connected: (OFF = R.T. contact OPEN = Thermostat not triggered); (ON = R.T. contact CLOSED = Thermostat triggered).
ASP.RPM	Indicates the speed of the fume extractor.
LOAD	Indicates the pellet loading interval.
STATUS T.A.	Indicates the status of the main room thermostat. (OFF = R.T. contact OPEN = Thermostat not triggered); (ON = R.T. contact CLOSED = Thermostat triggered).
AIR SPEED	Indicates the speed of the front air fan.
DUCT. 1	Indicates the speed of the air in ducted room 1.
DUCT. 2	Indicates the speed of the air in ducted room 2.
TIMER 1	Indicates the end (in minutes) of the current operating phase.
TIMER 2	Indicates the end (in seconds) of the current operating phase.
ALARM DELAY	In the event of an alarm, it indicates the time (in seconds) after which the alarm appears on the display.
T.MOTHERBOARD	Indicates the temperature measured by the probe inside the control unit.

G.A.S.	Indicates the status of the brazier cleaner. (OFF = Contact OPEN = Brazier not aligned) (ON = Contact CLOSED = Brazier aligned)
PELLET LEV.	Indicates the status of the pellet level sensor inside the tank. (OFF = Sensor covered = Pellets in the tank above the reserve limit) (ON = Sensor uncovered = Pellets in the tank below the reserve limit)
SERVICE	Indicates the hours remaining before servicing, to be requested from the Technical Assistance Centre.

Menu 08 – WiFi status

Allows for viewing the current status of the built-in Wi-Fi board.

The image below shows the display of the Wi-Fi board status:



The table below indicates the various items with the relevant meaning:

Display wording	Meaning	Values displayed	
SIGNAL	Indicates the value of the Wi-Fi signal measured by the reception board.	0 to 100	
CHANNEL	Indicates the channel to which the Wi-Fi board is connected.	1 – 6 – 11	
VERSION	Indicates the firmware version is loaded on the Wi-Fi board.	-	
WIFI STATUS	Indicates the status of the Wi-Fi board.	1	Initialisation
		2	Access Point
		3	Update download phase
		4	Update
		5	Station search
		6	Station found
		7	Attempt to connect to server
		8	Wi-Fi connection active
RESET	Allows for resetting the previously configured Wi-Fi connection.	-	

Menu 09 – User settings *

Menu reserved for expert users only; allows for calibrating pellet loading (TYPE PELLET) and the flue gas extraction speed (TYPE CHIMNEY) in a limited manner, according to the procedures indicated in the following table:

Menu	Meaning	Settable values
TYPE PELLETT	By increasing the value by a single unit, the pellet load is increased by about 2%.	-9 to +9
	By reducing the value by a single unit, the pellet load is reduced by about 2%.	
TYPE CHIMNEY	By increasing the value by a single unit, the flue gas extractor speed (and therefore the flow of combustion air) is increased by about 3%.	-9 to +9
	By reducing the value by a single unit, the flue gas extractor speed (and therefore the flow of combustion air) is reduced by about 3%.	

*** Unauthorised access can cause serious damage to equipment, objects and the environment, as well as personal injuries. Klover declines all responsibility deriving from improper calibration of these values.**

Menu 10 – Technical settings

Allows for accessing all data reserved for the Technical Assistance Centre. Access is protected by a password. Unauthorised access can cause serious damage to equipment, objects and the environment, as well as personal injuries.

INITIAL SETTINGS

Connecting the remote control

Whenever the product is switched on for the first time or the user wishes to change the connection channel, the remote control should be interfaced with the support panel mounted on the device, by proceeding as follows:

1. Simultaneously press and hold for a few seconds buttons 3 (On/Off) and 4 (Set) of the remote control.
2. The wording "RADIO ID MENU" will appear alongside – if previously configured – the channel with which the remote control has been associated.
3. Press button 2 (Decrease) of the remote control to select "NEW" and confirm with button 4 (Set).
4. Use button 1 or 2 (Increase or Decrease) of the remote control to select the channel on which to make the connection, without confirming with button 4 (Set).
5. Simultaneously press and hold buttons 1 (On/Off) and 2 (Power) of the support panel until all LEDs light up.
6. Confirm the previously selected channel using button 4 (Set) of the remote control, which will then start searching for the channel to which it must connect.
7. If the operation was carried out correctly, the remote control will display the appliance's usage window. If not, a message will appear to signal that the channel has not been found; in such case, repeat the operation.

Connection to the Wi-Fi network

The appliance is equipped with a Wi-Fi board that enables it to be remotely controlled via the "My Klover" Web app, which can be downloaded to smartphones, tablets or PCs from various stores (Apple, Android, etc.).

The procedure for connecting the Wi-Fi board to the domestic network is explained below ([also refer to the "Menu 08 – WiFi status" paragraph in the "THE MENU" chapter](#)):

1. Power the appliance by touching the "ON/OFF main switch" located on the rear of the appliance itself.
2. Check that inside "Menu 08 – WIFI STATUS" of the remote control, under "WIFI STATUS", value "02" (Access Point) is present; if not, run the "RESET" procedure present in "Menu 08 – WIFI STATUS".
3. Use a device equipped with a Wi-Fi peripheral (PC / tablet / smartphone) to make the connection to the Wi-Fi network created from the Wi-Fi module.
The name of the network to be searched (SSID) will be similar to "Klover-Wifi_xxxxxx", where "xxxxxx" denotes the part of the MAC address of the module.
Check that the device equipped with a Wi-Fi peripheral (PC / tablet / smartphone) has actually connected to the network created by the appliance's Wi-Fi module.

4. Open the current browser (Internet Explorer, Firefox, Safari, etc.) used by the device and enter the following address in the address bar: <http://192.168.1.1> .



5. The home page of the Wi-Fi module will open up (Welcome to Wi-Fi Setup). Select the language to be used for the successive Wi-Fi module configuration menus.



6. A new page will open up (Welcome to Wi-Fi Setup) containing all the data relative to the previous configuration. To reconnect the module to the indicated network, go to "Menu 08 – WIFI STATUS" of the remote control, select "RESET" and wait for value "08" (Module connected) to appear under "WIFI STATUS". If you wish to connect to a new network, press the Search Wi-Fi Networks button.

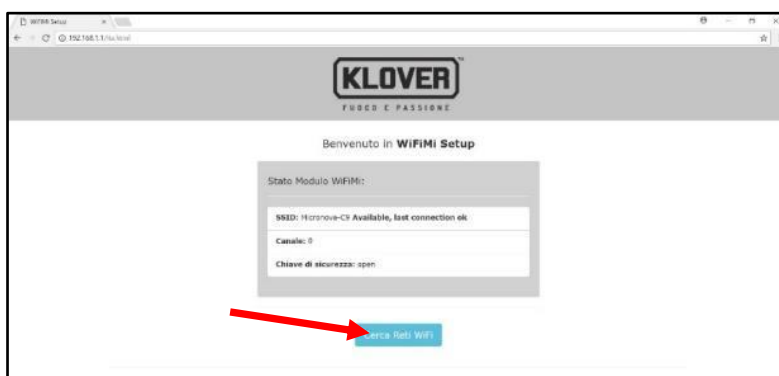

7. The last configuration page will then open up (Search available Wi-Fi networks). Select the network to be used from the list in order to connect the appliance to the Internet then enter the password for the selected network. If the network is hidden, click on Custom SSID and enter the two parameters requested.

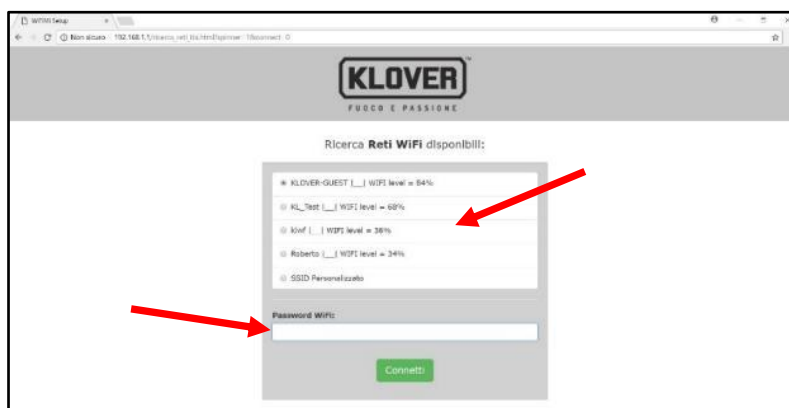

8. Click on "Connect" to connect the appliance to the selected Wi-Fi network.

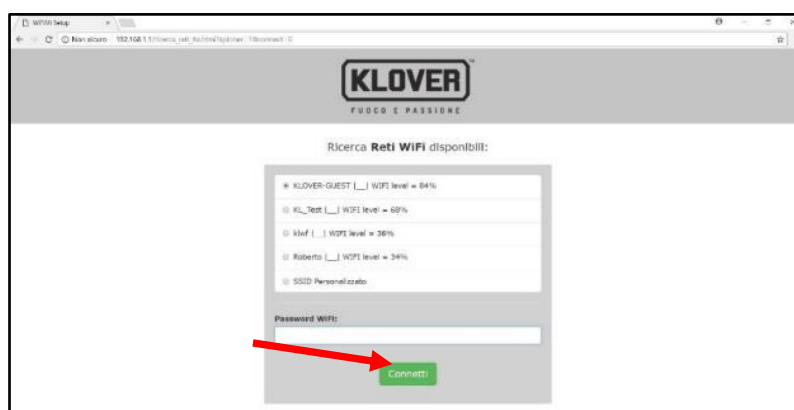

9. Within "Menu 08 – WIFI STATUS" of the remote control, check that value "08" (Module connected) appears under "WIFI STATUS".



10. At this point, the device you have purchased will be stably connected to the Internet. Open the current browser of the device (PC / tablet / smartphone) and enter the following address in the address bar: <https://appwifi.klover.it/it/login/>. The page of the "My Klover" Web app will open up; click on the "Register" section in the main menu. After completing the registration, you will receive a confirmation e-mail in your mailbox. The registration can be made from the "My Klover" app, which can be downloaded to smartphones, tablets or PCs from various stores (Apple, Android, etc.).
11. Return to the home page of the "My Klover" app and access your account by entering the credentials (e-mail address and password) previously used for the registration phase. You can now add a new appliance by clicking in the "Add stove" section of the main menu.

The following information will be requested during the procedure:

- **ITEM CODE (Model)** and **SERIAL NUMBER**, which can be found on the CE label affixed to the appliance.

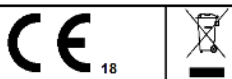
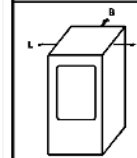
Model	 KLOVER 37047 San Bonifacio (VR) web: www.klover.it e-mail: klover@klover.it AURA 80 Model: A80 Serial number: A80-A0001 EN 14785 : 2006	Nominal heat input	: 8,5 kW
		Nominal heat output	: 7,8 kW
Serial number	 Minimum clearance from combustible material: R = 150 mm L = 150 mm B = 200 mm	Reduced heat output	: 2,5 kW
		Carbon monoxide at 13% Oxygen	Nominal : 0,006 % Reduced : 0,058 %
		Efficiency	Nominal : 91,8 % Reduced : 93,8 %
		Medium power consumption	: 66 W
		Nominal voltage	: 230 V
		Nominal frequency	: 50 Hz
		<i>Read instruction before using</i>	
		<i>Use only recommended combustible</i>	

- **MAC ADDRESS** and **REGISTRATION CODE**, which appear on the label affixed near the “Support panel” (see “Components of the appliance”).

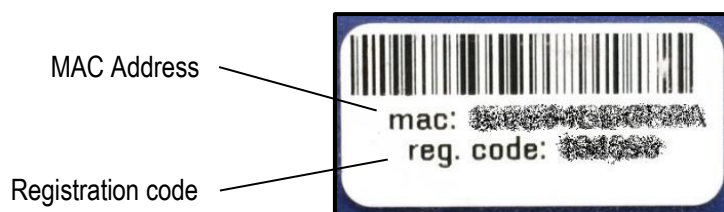

12. At this point, the appliance will be added and can be managed through the Web app from any device (PC / tablet / smartphone) connected to the Internet.

It can be accessed from the address <http://appwifi.klover.it/> or via the “My KLOVER” app, which can be downloaded from various stores (Apple, Android, etc).

COMMISSIONING

Initial start-up

Perform the following operations:

- Connect the appliance to the electrical system using the cable provided;
- Set the “power ON/OFF switch” on the rear side of the appliance to “1” (on);
- Fill the pellet tank; for the initial start-up, we recommend observing the procedure specified in “MENU 06 – INITIAL LOAD” to avoid having to fill the entire auger feed channel (**this operation should be carried out whenever the appliance runs out of pellets**).
- Switch the appliance on by pressing the “ON/OFF” button located on remote control (button 3) or on the support panel (button 1). Refer to the instructions provided below. **Warning: before switching on the appliance, make sure the brazier is clean and that there are no pellets inside it; otherwise, empty and/or clean it.**

We recommend using good quality pellets so as to avoid impairing the appliance’s operation. Damage caused by poor quality pellets shall not be covered by the warranty.

Do not pour pellets manually into the brazier.

Ignition cycle

Prolonged pressing of button 3 (On/Off) on the remote control or of button 1 (On/Off) on the support panel allows for switching the appliance on.

The ignition cycle can last maximum 20–25 minutes and is divided into five steps:

Phase	Display wording	Meaning	Duration
1	CHECK UP	Brazier cleaning cycle	Roughly 30 seconds
2	LOAD PELLET	Pre-loading of the brazier with pellets (continuous pellet loading) to fill the brazier sufficiently to allow correct ignition	Roughly 4 minutes
3	FIRE WAIT	Stand-by for flame ignition after pre-loading (pellet loading suspended)	Roughly 4 minutes
4	FIRE WAIT / LOAD PELLET	Loading of pellets into brazier (intermittent pellet loading)	Not ascertainable
5	FLAME LIGHT	Flame stabilisation to allow uniform ignition of all pellets that were not burned in the previous phases	Roughly 8 minutes

At the end of the ignition cycle, the appliance enters the work mode at the power set under “SET OUTPUT”.

If the ignition fails, the display will show the “*FAILED IGNITION*” alarm.

The alarm may also occur if the brazier is dirty; in this case, clean the brazier and restart the appliance.

Warning: during the ignition phase and normal operation of the appliance, keep at a safe distance from the latter and do not stand in front of it.

Work mode

During the normal work phase, pressing button 1 (Increase) allows for setting the “*SET ROOM*” (room temperature set-point) at which the appliance enters the “*MODULATION*” economy mode, provided that all the other room thermostats or probes (if any) have been fulfilled (also refer to “*Connection to the room thermostat or to a supplementary room probe*”).

- With “Menu 01-STAND-BY” enabled, the appliance switches off automatically by entering the “OK ST-BY” status after the time set in Pr44 (default setting 10 minutes); after the switch-off phase, it will switch back on automatically if the room temperature falls below the temperature delta set at Pr43 (default setting 1°C), or room temperature < (“*SET ROOM*” – Pr43).
- With “Menu 01-STAND-BY” not enabled, the appliance enters the “*MODULATION*” mode once the set room temperature is reached, but will not switch off automatically.

If the above condition occurs when the switch-off cycle is not yet completed, please wait until the cycle terminates.

The brazier cleaning cycle (indicated in the display by “*CLEANING FIRE-POT*”) is done at pre-defined time intervals for a pre-defined duration (see “*PCB parameters*”).

Switch-off cycle

Pressing button 3 (On/Off) on the remote control or button 1 (On/Off) on the support panel switches the appliance off. The display will show “*FINAL CLEANING*”. Pellet loading stops and the flue gas extractor speed increases to maximum and then switches off once the appliance has cooled, with “*OFF*” appearing on the display. In addition, during this phase the brazier is cleaned and emptied.

Modifying the main room temperature set-point

- To modify the room temperature, simply select “*SET ROOM*” by pressing button 1 (Increase).
- Press buttons 1 and 2 (Increase and Decrease) to modify the value and confirm with button 4 (Set) or 5 (Esc); it is possible to set a value between 7°C and 40°C.

- By pressing button 3 (On/Off) or waiting a few seconds without confirming, the set value is not saved.

During this operation, the display will appear as shown below:



SET ROOM
(Main room temperature
set-point of zone 1,
settable to between 7°C
and 40°C)

During the work phase, the appliance enters the “MODULATION” economy mode when this temperature value is reached (see “Work phase”).

Modifying the power set-point

- To modify the working power, simply select “SET OUTPUT” by pressing button 2 (Decrease).
- Press buttons 1 and 2 (Increase and Decrease) to modify the value and confirm with button 4 (Set) or 5 (Esc); it is possible to set a power value between 1 and 5.
- By pressing button 3 (On/Off) or waiting a few seconds without confirming, the set value is not saved.

During this operation, the display will appear as shown below:



SET OUTPUT
(Working power settable to
between 1 and 5)

Modifying the fan air speed set-point

- To modify the speed of the frontal air fan, simply select “SET AIR” by pressing button 5 (Esc).
- Press button 2 (Decrease) to modify the value associated with the frontal air fan and confirm with button 4 (Set) or 5 (Esc); it is possible to manually set a speed value between 1 and 5, or an automatic speed (A) associated with the value set under “SET OUTPUT” (see “Modifying the power set-point”).
- By pressing button 3 (On/Off) or waiting a few seconds without confirming, the set value is not saved.

During this operation, the display will appear as shown below:

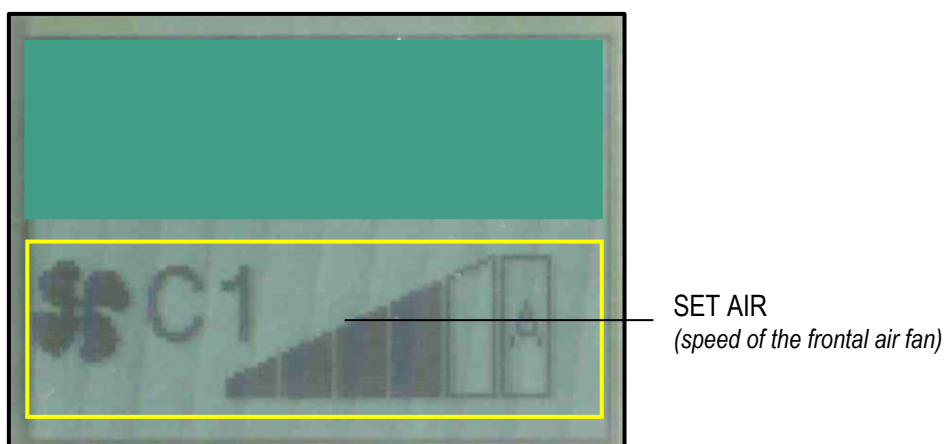

PROBLEMS, ALARMS, USEFUL ADVICE

Useful info...

Listed below is some important information regarding the appliance:

- It is normal for the appliance to emit a smell of paint during its first few days of operation. We recommend ventilating the installation room during the initial start-up. During the first few days of operation, we also recommend running the appliance at high power.
- The boiler unit is treated with anti-oxidant paint in order to protect it against oxidation in the event of long periods of inactivity. After the initial start-up, this paint no longer preserves its original features and any wear of the paint inside the combustion chamber should not be regarded as a manufacturing defect.
- Do not use water to clean the inside of the combustion chamber; any oxidation of the combustion chamber after long periods of inactivity should not be regarded as a manufacturing defect.
- Any perceived noise during operation may be caused by the expansion settling of the plates making up the boiler body. These noises are enhanced especially during the ignition and switch-off phases of the appliance and are not to be regarded as manufacturing defects.
- If the ignition fails, take the pellets out of the brazier; only once all the unburned pellets have been removed can a new ignition phase be attempted.
- Any perceived smell of smoke (especially during the ignition phase) should not be regarded as a manufacturing defect.
- The appliance works exclusively with wooden pellets; do not burn different fuels.
- The noise level of the appliance is enhanced if the pellet container is empty. Therefore, we recommend always keeping the pellet level to at least half-tank.
- If there is soot and fine particulate in the room where the appliance is installed, check the seal on the smoke pipes and the filter of the ash vacuum device used for cleaning.

What happens if...

...the pellets do not ignite

If the ignition fails, the display will show the alarm message *"FAILED IGNITION"*.

Cancel the alarm and restore the appliance to its standard condition by pressing button 3 (On/Off) for a few seconds.

If the ignition fails, take the pellets out of the brazier; only once all the unburned pellets have been removed can a new ignition phase be attempted.

...the fire door is open or not properly closed

If the door is left open or not properly closed, pellet loading will not start and the appliance will not switch on. If the fire door is opened during normal operation, the appliance will enter the *"THERMAL SAFETY"* alarm mode.

...the pellet tank cover is open or not properly closed

If the pellet tank cover is left open or not properly closed, pellet loading will not start and the appliance will not switch on. If the cover is opened during normal operation, the appliance will enter the "NO DEPRESSURE" alarm mode.

...the flue pipe is dirty, clogged or incorrectly installed

If the flue pipe is dirty, clogged or incorrectly manufactured, pellet loading will not start and the appliance will not switch on. If the flue pipe is obstructed during normal operation, the appliance will enter the "NO DEPRESSURE" alarm mode.

...the pellet tank overheats

If the pellet tank overheats (>85°C), the pellet will not be loaded because the manual reset thermostat intervenes. If this occurs during normal operation, the appliance will enter the "THERMAL SAFETY" alarm mode. It is therefore necessary to reset the "manual reset safety thermostat" (refer to "Components of the appliance") before switching the appliance on again. To reset the thermostat, it is necessary to remove the black cap and press the underlying button.

...lack of power (blackout)

If a power blackout occurs for a shorter time than Pr48, when power is restored the appliance will immediately re-start in the working mode (recovering the set working power).

If the outage lasts longer than Pr48, when power is restored the appliance will enter the "CLEANER STAND-BY" mode and run the entire switch-off and cleaning cycle until the appliance cools. When this phase is over, the appliance can be restarted resuming work at the set power.

Previous status	Black-out duration	Status after power restore
OFF	any	OFF
CHECK UP	any	CHECK UP
LOAD PELLET	any	BLACK OUT ALARM
FIRE WAIT	any	BLACK OUT ALARM
FIRE WAIT / LOAD PELLET	any	BLACK OUT ALARM
FLAME LIGHT	Duration < Pr48	FLAME LIGHT
FLAME LIGHT	Duration > Pr48	CLEANER STAND-BY with automatic re-ignition after machine cooling
WORK (any phase)	Duration < Pr48	WORK (any phase)
WORK (any phase)	Duration > Pr48	CLEANER STAND-BY with automatic re-ignition after machine cooling
CLEANING FIRE-POT	Duration < Pr48	CLEANING FIRE-POT
CLEANING FIRE-POT	Duration > Pr48	CLEANER STAND-BY with automatic re-ignition after machine cooling
FINAL CLEANING	any	FINAL CLEANING and after cooling OFF
STAND-BY	any	STAND-BY

Alarm signals

The following table describes the different alarms which may appear.

DISPLAY VISUALISATION	ORIGIN OF ALARM
AL. 01 – BLACK OUT	Black-out alarm. When power cuts off in certain conditions (see "What happens if...").
AL. 02 – SMOKE TEMP.	Faulty or disconnected smoke temperature probe.
AL. 03 – REG.ENCODER	This occurs when the speed of the smoke extractor does not correspond to the set speed.
AL. 04 – NO ENCODER	Smoke extractor or smoke extractor encoder faulty. This occurs when the (tachometer) encoder in the extractor detects an extractor speed equal to 0.
AL. 05 – FAILED IGNITION	No ignition. This occurs when the minimum temperature in the combustion chamber (Pr13) is not reached within the maximum ignition cycle time (Pr01).
AL. 06 – CHECK PELLETS	Sudden shutdown during the work phase. This occurs when the temperature in the combustion chamber drops below the minimum threshold (Pr13) during the work phase.
AL. 07 – THERMAL SAFETY	Temperature safety device. This occurs when the safety thermostat intervenes (pellet tank overheating) or when the fire door is open or not correctly closed. If the safety thermostat intervenes, it needs to be reset manually (refer to "Components of the appliance").

AL. 08 – NO DEPRESSURE	Lack of depression. This occurs when the smoke pressure switch intervenes due to poor draught in the flue pipe or when the pellet tank cover is open.
AL. 10 – LOAD ALARM	This occurs when there is continuous loading of pellets (the auger gearmotor does not stop for at least 0.2 seconds during the maximum work interval of 8.0 seconds). Before the alarm is activated, a safety relay intervenes and forcibly cuts off the power supply to the gearmotor.
AL. 11 – INSUFF. DRAUGHT	This occurs when the measured combustion air flow is below the set threshold. NOT APPLICABLE TO THIS PRODUCT.
AL. 12 – CLEANER FAULT	This occurs when the brazier is not correctly aligned during the cleaning phase (initial or during shutdown).

Every alarm causes the appliance to switch-off immediately. The alarm status is reached after the time set on Pr11 (set by default to 90 sec.) and can be reset by pressing and holding button 3. In case of anomalies, contact the *Klover authorised Technical Assistance Centre*.

CLEANING AND MAINTENANCE

Precautions before cleaning

Before carrying out any cleaning or maintenance operations, make sure that:

- the appliance is off and has cooled down completely;
- the ash is completely cold.
- the ash vacuum device used for cleaning is suitable and its filter is in good condition.

Before re-starting the appliance, re-install all previously removed components.

During cleaning operations, use the personal protective devices specified in Directive 89/391/EEC.

The required cleaning frequency depends on the type and quality of the pellets used. The schedule indicated below may therefore vary.

Any problem affecting the appliance caused by lack of cleaning will not be covered by the warranty. Failing to fulfil these operations could affect the safety of the product.

Cleaning operations may be carried out by the end user, as indicated in the paragraph below.

Routine cleaning

The ordinary cleaning of the appliance must be done at least every 30 hours of operation or after 6–8 ignition cycles, so as to always guarantee efficient performance and optimal operation. Proceed as illustrated below:



Use the appropriate *cleaning hook for the front scraper* to pull out the front rod and then move it forward and backwards to clean off combustion residues from the air exchanger (Figure 1). Suck up the residual ash deposited above the flame separator (Figure 2).



Remove the brazier covering ring and the grille then eliminate the combustion residues (Figures 3 and 4).



Vacuum the ash deposited inside the brazier (Figure 5) and outside of it (Figure 6). If necessary, scrape the bottom to eliminate any combustion residues.

WARNING: use suitable ash vacuum devices equipped with a fine-mesh filter in order to prevent ash from being blown into the room and damages to the vacuum cleaner. We do not recommend the use of normal vacuum cleaners.

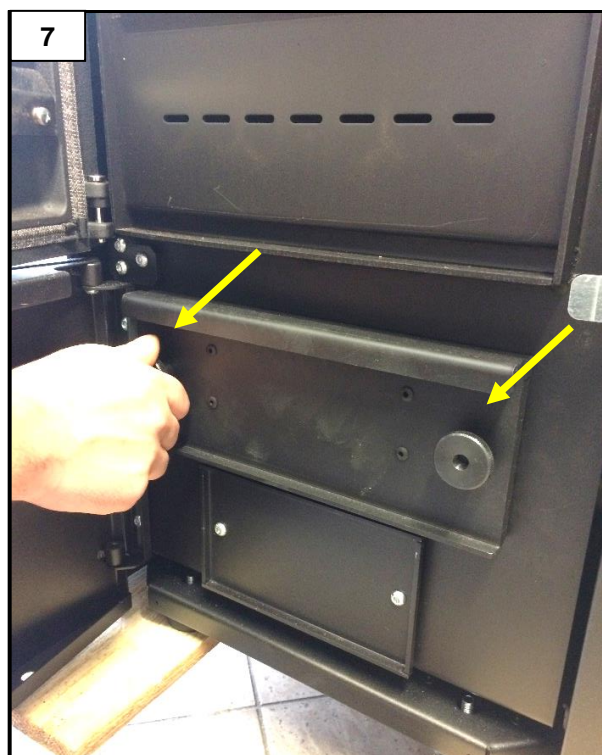

After opening the lower inspection door, remove the two knobs on the ash box (Figure 7) and empty the latter (Figure 8).



Vacuum any residues inside the ash box compartment (Figure 9).

Reassemble all the previously removed components, making sure that the seals guarantee perfect tightness.

Non-routine cleaning

Non-routine cleaning of the appliance must be done at least every 30 days so as to always guarantee its efficient performance and optimal operation. Proceed as illustrated below:

Perform routine cleaning;



Remove the cover of the inspection port by loosening the two screws (Figure 10) and vacuum any residues inside the inspected compartment (Figure 11).



To ensure correct operation, it is necessary to remove the sawdust deposited on the bottom of the tank (Figure 12) at least once every 30 days. **The pellet tank must be emptied at the end of every season.**

Annual cleaning

Annual cleaning of the appliance must be carried out at least once a year so as to always guarantee its efficient performance and optimal operation. Proceed as illustrated below:

Perform routine and extraordinary cleaning;

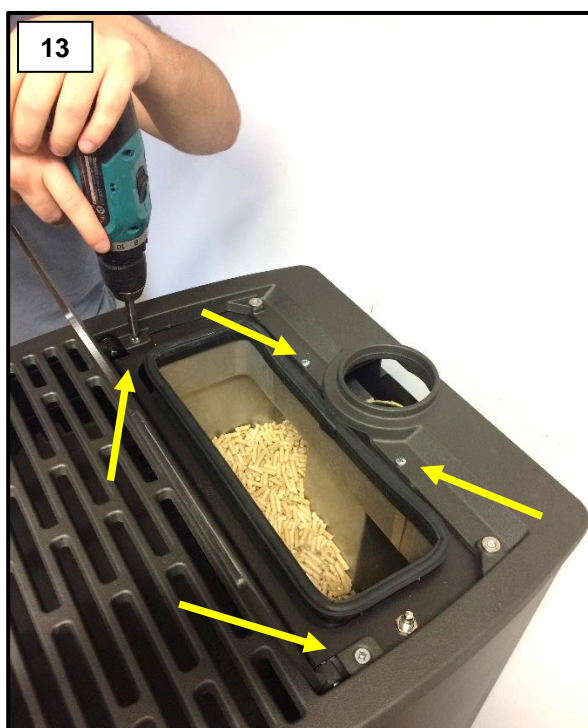

Remove the cast iron top, by loosening the two screws shown in the picture (Figure 13).

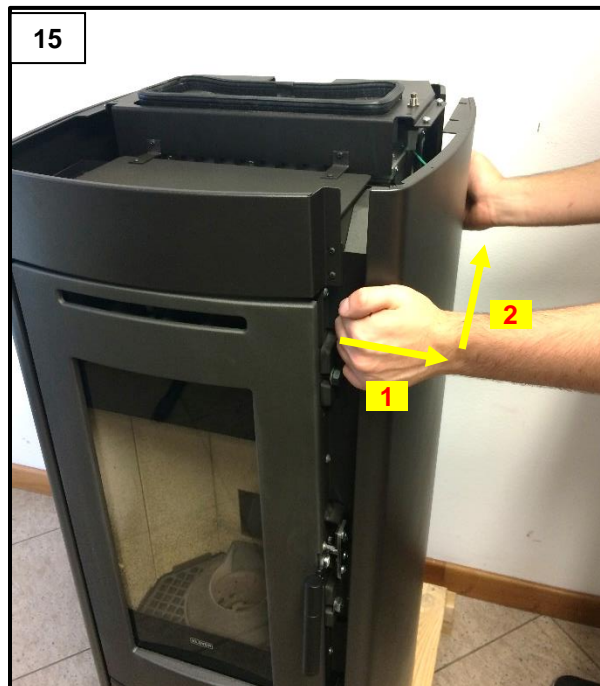
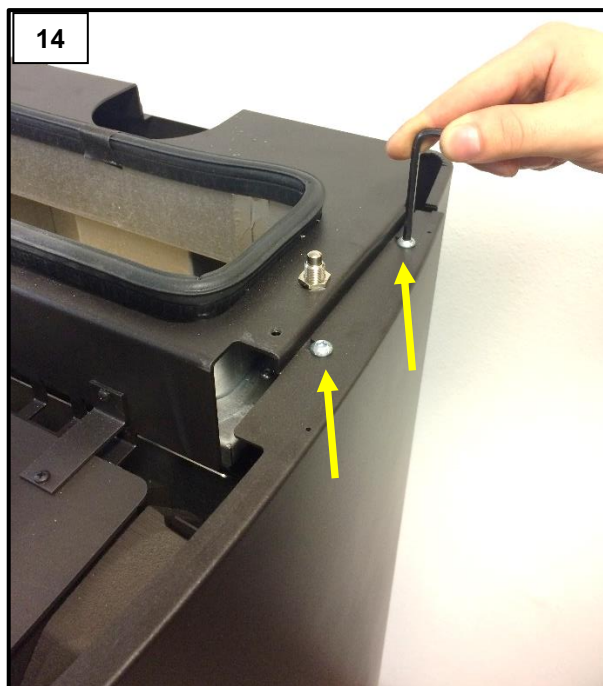

Loosen the two screws shown in the picture (Figure 14) and dismantle the two RH and LH side panels (Figure 15).



Remove the cover of the cast iron top (Figure 17), by loosening the five screws shown in the picture (Figure 16).



Use a pipe cleaner or a vacuum cleaner to remove any dust residues from the cast iron heat exchanger (Figure 18).

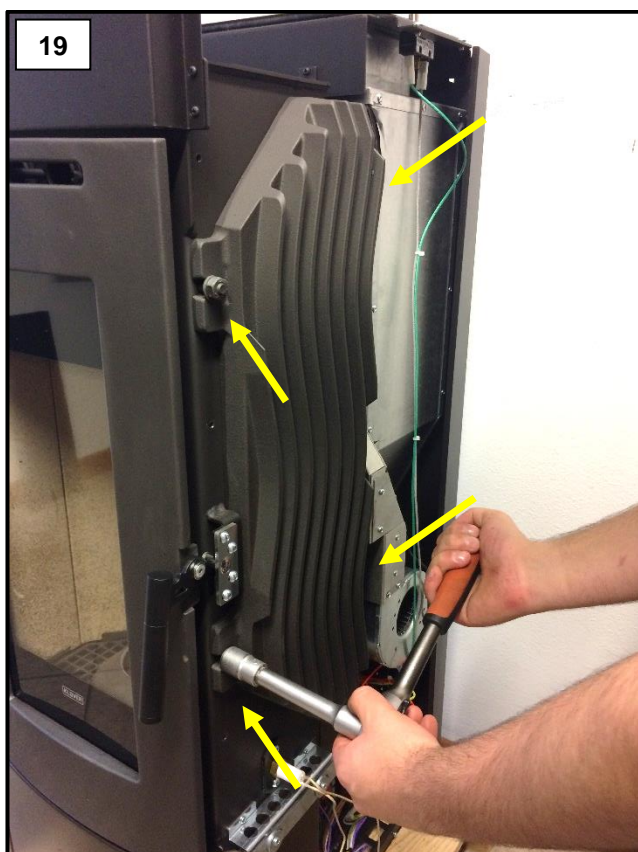

Remove the cast iron heat exchanger (Figure 20), by loosening the 4 nuts shown in the picture (Figure 19).

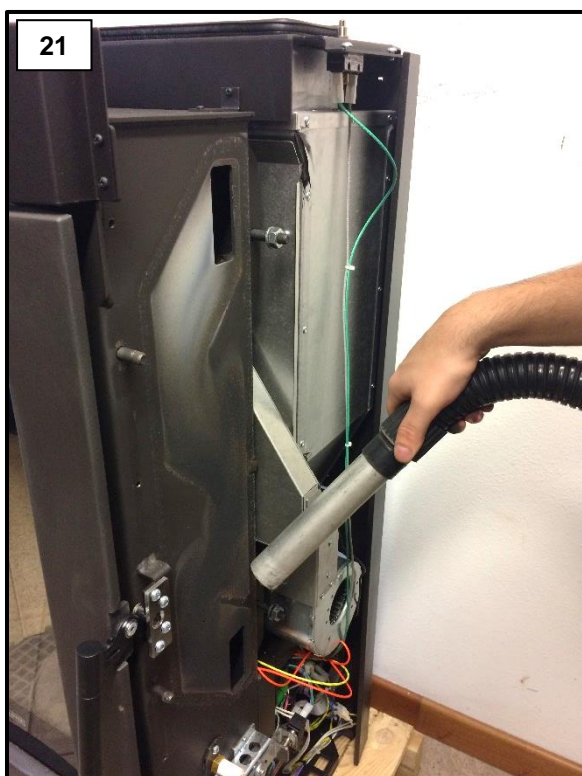

Use a steel scraper to scrape the side walls of the stove (Figure 21) and the inner walls of the cast iron heat exchanger (Figure 22) then vacuum the residues.

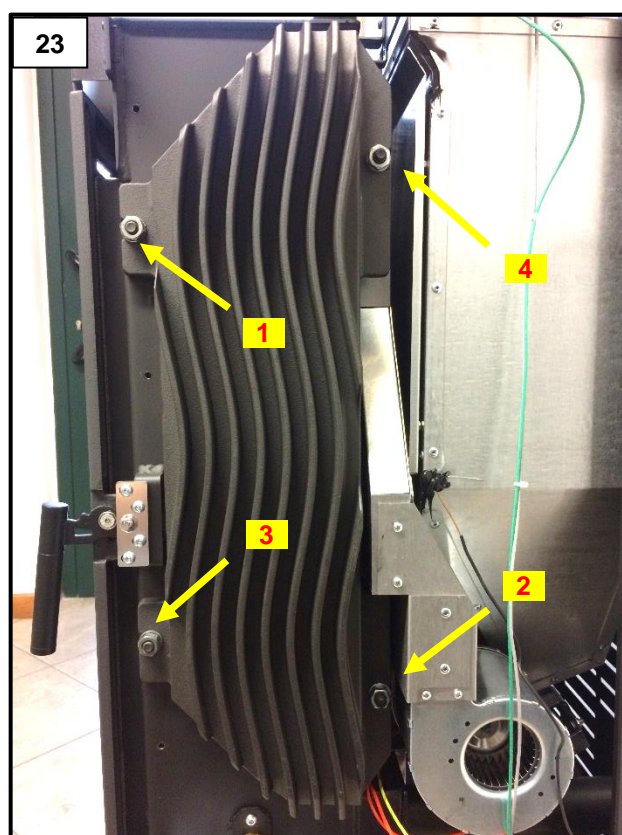

Reassemble all the previously removed components, making sure that the seals guarantee perfect tightness. When tightening the nuts of the cast iron heat exchanger, it is advisable to observe the sequence shown in the picture (from 1 to 4) to ensure the adequate tightness of the seal (Figure 23).

Cleaning the vermiculite components

The vermiculite panels do not require any special maintenance. If necessary, they must be dusted gently using a brush only. To avoid jeopardising their durability, they must not be cleaned using abrasive sponges, wet cloths or the tube of the ash vacuum device placed directly in contact with it.

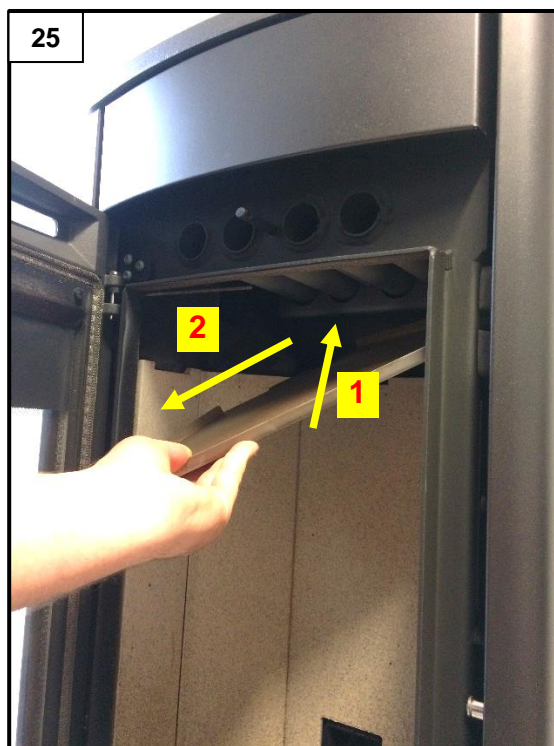

Remove the flame separator as shown in the picture (Figures 24 and 25).

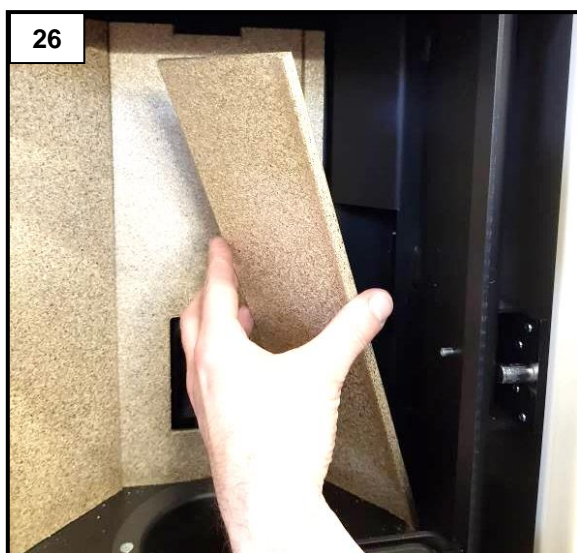

To remove the vermiculite components, first remove the outer panels and then the rear panel (Figures 26 and 27).
WARNING: handle the vermiculite panels very carefully as they do not withstand impacts.

Cleaning the glass-ceramic panel

Always clean the glass when the appliance is off and has cooled down completely. Use a damp cloth or a detergent specifically formulated for glass-ceramic. Do not use abrasive sponges. Do not clean the glass if it is still warm; temperature changes can cause it to break.

Cleaning the flue

The flue must be cleaned at least once a year, at the beginning of winter, and whenever it becomes necessary. It is important to check for any obstructions in the flue before switching the appliance on following long periods of inactivity.

If the flue is not cleaned, the operation of the appliance and its components may be impaired.

The frequency of cleaning of the appliance and flue depends on the quality of the pellets used.

USE PREMIUM-QUALITY PELLETS FOR BEST RESULTS.

Maintenance

Timely and systematic maintenance is essential for guaranteeing correct operation, optimal heating performance and durability of the entire device. Therefore, the device should be checked by qualified staff at least once a year at the beginning of the season.

It is necessary to periodically check the seals as they guarantee air- and water-tightness of the appliance and its efficient operation; if they are worn or damaged, they must be replaced immediately by contacting a ***Klover authorised Technical Assistance Centre***.

For proper operation, the appliance must undergo routine maintenance performed by a *Klover authorised Technical Assistance Centre* at least once a year.

PCB PARAMETERS

The parameters stored on the PCB are essential for the correct operation of the device.

The following parameters are already stored when the appliance is tested directly in the factory; these parameters stem from rigorous tests using several types of pellets and must not be modified without the authorisation of Klover S.r.l. to avoid impairing the appliance's operation.

The company shall not be held liable for any damage caused by the incorrect entry of parameters.

Parameter tables SOFT 80

"CLEANER SETTINGS" parameters - Model S80 (L09_161018)						
Parameter	Menu level	Description	Display wording	Measurement	Value field	Database o9
Pr51	M10 – 01 – 01	ON time for brazier cleaning gearmotor	CLEANER DURATION	Seconds	0 – 120	13
Pr52	M10 – 01 – 02	Time from switching off after which the brazier cleaning cycle starts	CLEANER DELAY	Minutes	1 – 15	6
Pr53	M10 – 01 – 03	Time from switching on after which the brazier cleaning cycle starts	CLEANER STAND-BY	Hours	1 – 24	9

"DUCTING SETTINGS" parameters - Model S80 (L09_161018)						
Parameter	Menu level	Description	Display wording	Measurement	Value field	Database o9
Pr55	M10 – 03 – 01	Enables ducting operation	ENABLE DUCT.	Off / Mode	Off S1 – S2 – S1+2 T1 – T2 – T1+2 A1 – A2 – A1+2	A1
Pr56	M10 – 03 – 02	Allows for choosing whether the ducted air fans can be switched "OFF".	DUCTED OFF	On – Off	On – Off	On
Pr57	M10 – 03 – 03	Heat exchanger 2 (ducting 1) in power 1 work phase	DUCT.1 SPEED-S1	Volt	65 – 225	150
Pr58	M10 – 03 – 04	Heat exchanger 2 (ducting 1) in power 2 work phase	DUCT.1 SPEED-S2	Volt	65 – 225	160
Pr59	M10 – 03 – 05	Heat exchanger 2 (ducting 1) in power 3 work phase	DUCT.1 SPEED-S3	Volt	65 – 225	170
Pr60	M10 – 03 – 06	Heat exchanger 2 (ducting 1) in power 4 work phase	DUCT.1 SPEED-S4	Volt	65 – 225	180
Pr61	M10 – 03 – 07	Heat exchanger 2 (ducting 1) in power 5 work phase	DUCT.1 SPEED-S5	Volt	65 – 225	195
Pr62	M10 – 03 – 08	Heat exchanger 3 (ducting 2) in power 1 work phase	DUCT.2 SPEED-S1	Volt	65 – 225	65
Pr63	M10 – 03 – 09	Heat exchanger 3 (ducting 2) in power 2 work phase	DUCT.2 SPEED-S2	Volt	65 – 225	65
Pr64	M10 – 03 – 10	Heat exchanger 3 (ducting 2) in power 3 work phase	DUCT.2 SPEED-S3	Volt	65 – 225	65
Pr65	M10 – 03 – 11	Heat exchanger 3 (ducting 2) in power 4 work phase	DUCT.2 SPEED-S4	Volt	65 – 225	65
Pr66	M10 – 03 – 12	Heat exchanger 3 (ducting 2) in power 5 work phase	DUCT.2 SPEED-S5	Volt	65 – 225	65

"GENERAL SETTINGS" parameters - Model S80 (L09_161018)						
Parameter	Menu level	Description	Display wording	Measurement	Value field	Database o9
Pr38	M10 – 04 – 01	Re-start block	RESTART BLOCK	Minutes	0 – 10	5
Pr39	M10 – 04 – 02	Time for considering the device off	OFF TIME	Minutes	0 – 20	10
Pr40	M10 – 04 – 03	Pre-loading time in ignition	PRE-LOAD START	Seconds	0 – 255	215
Pr41	M10 – 04 – 04	Stand-by time after pre-loading	AFTER PRE-LOAD	Seconds	0 – 255	230
Pr42	M10 – 04 – 05	Extractor speed in pre-loading phase	PRE-LOAD SMOKE SPEED	Rpm	350 – 2800	2300
Pr43	M10 – 04 – 06	Temperature delta on "SET ROOM" for automatic switching on/off	DELTA ON-OFF	°C	0.0 – 10.0	1.0
Pr44	M10 – 04 – 07	Automatic switch-off delay (timer after reaching "SET ROOM")	AUTO OFF DELAY	Minutes	2 – 120	10
Pr45	M10 – 04 – 08	Power change delay	POWER CHANGE	Seconds	0 – 240	60
Pr46	M10 – 04 – 09	Heat exchanger 1 speed (primary) in the switch-off phase	AIR SPEED OFF	Volt	65 – 225	195
Pr47	M10 – 04 – 10	Keypad lock enabling	KEY LOCK	On – Off	On – Off	Off
Pr48	M10 – 04 – 11	Time after which an alarm is triggered in the event of a blackout	BLACK OUT TIME	Seconds	0 – 60	30
Pr49	M10 – 04 – 12	Time after which the "NO PELLET" alarm triggers if "PELLET RESERVE"	ALARM RESERVE	Minutes	1 – 180	60
Pr50	M10 – 04 – 13	Enabling of the pellet level sensor (only on configured models)	PELLET RESERVE	On – Off	On – Off	Off

"FACTORY SETTINGS" parameters - Model S80 (L09_161018)						
Parameter	Menu level	Description	Display wording	Measurement	Value field	Database o9
Pr01	M10 – 05 – 01	Ignition cycle maximum time	START TIME	Minutes	5 – 25	18
Pr02	M10 – 05 – 02	Time for flame stabilisation after ignition	FL. LIGHT TIME	Minutes	0 – 15	9
Pr03	M10 – 05 – 03	Time interval between the two brazier cleaning cycles	CADENCE CLEANING	Minutes	3 – 240	60
Pr04	M10 – 05 – 04	Auger gearmotor ON time in ignition phase	AUGER START	Seconds	0.1 – 8.0	0,8
Pr05	M10 – 05 – 05	Auger gearmotor ON time during the stabilisation phase	AUGER FL. LIGHT	Seconds	0.1 – 8.0	1,2
Pr06	M10 – 05 – 06	Auger gearmotor ON time in power 1 work phase	AUGER POWER 1	Seconds	0.1 – 8.0	1,8
Pr07	M10 – 05 – 07	Auger gearmotor ON time in power 2 work phase	AUGER POWER 2	Seconds	0.1 – 8.0	2,4
Pr08	M10 – 05 – 08	Auger gearmotor ON time in power 3 work phase	AUGER POWER 3	Seconds	0.1 – 8.0	3,0
Pr09	M10 – 05 – 09	Auger gearmotor ON time in power 4 work phase	AUGER POWER 4	Seconds	0.1 – 8.0	3,8
Pr10	M10 – 05 – 10	Auger gearmotor ON time in power 5 work phase	AUGER POWER 5	Seconds	0.1 – 8.0	4,5
Pr11	M10 – 05 – 11	Time after which the alarm is signalled following an anomaly	ALARMS DELAY	Seconds	0 – 120	90
Pr12	M10 – 05 – 12	Brazier cleaning duration	CLEANING DURATION	Seconds	0 – 120	60
Pr13	M10 – 05 – 13	Minimum temperature of the combustion chamber in order to consider the appliance on	MINIMUM THRESHOLD	°C	70 – 280	180
Pr14	M10 – 05 – 14	Maximum temperature of the combustion chamber	MAXIMUM THRESHOLD	°C	200 – 880	800
Pr15	M10 – 05 – 15	Combustion chamber temperature threshold for starting the air exchangers	BLOWER THRESHOLD	°C	100 – 720	180
Pr16	M10 – 05 – 16	Smoke extraction speed in ignition phase	SMOKE SP. START	Rpm	500 – 2800	2100
Pr17	M10 – 05 – 17	Smoke extraction speed in start phase	SMOKE SP. FL. LIGHT	Rpm	500 – 2800	2000
Pr18	M10 – 05 – 18	Smoke extraction speed in power 1 work phase	SMOKE SPEED P1	Rpm	500 – 2800	1550
Pr19	M10 – 05 – 19	Smoke extraction speed in power 2 work phase	SMOKE SPEED P2	Rpm	500 – 2800	1700
Pr20	M10 – 05 – 20	Smoke extraction speed in power 3 work phase	SMOKE SPEED P3	Rpm	500 – 2800	1900
Pr21	M10 – 05 – 21	Smoke extraction speed in power 4 work phase	SMOKE SPEED P4	Rpm	500 – 2800	2100
Pr22	M10 – 05 – 22	Smoke extraction speed in power 5 work phase	SMOKE SPEED P5	Rpm	500 – 2800	2200
Pr23	M10 – 05 – 23	Heat exchanger 1 (primary) speed in power 1 work phase	AIR SPEED P.1	Volt	65 – 225	150
Pr24	M10 – 05 – 24	Heat exchanger 1 (primary) speed in power 2 work phase	AIR SPEED P.2	Volt	65 – 225	160
Pr25	M10 – 05 – 25	Heat exchanger 1 (primary) speed in power 3 work phase	AIR SPEED P.3	Volt	65 – 225	170
Pr26	M10 – 05 – 26	Heat exchanger 1 (primary) speed in power 4 work phase	AIR SPEED P.4	Volt	65 – 225	180
Pr27	M10 – 05 – 27	Heat exchanger 1 (primary) speed in power 5 work phase	AIR SPEED P.5	Volt	65 – 225	195
Pr28	M10 – 05 – 28	Combustion chamber temperature threshold for considering the device off	THRESHOLD OFF	°C	50 – 250	170
Pr29	M10 – 05 – 29	Smoke extraction speed in the brazier cleaning phase	SMOKE SP. CLEANING	Rpm	700 – 2800	2800
Pr30	M10 – 05 – 30	Auger gearmotor ON time in the cleaning phase	AUGER CLEANING	Seconds	0.0 – 8.0	1,0
Pr31	M10 – 05 – 31	Enabling of a primary room temperature probe connected to the board	MOTHERBOARD PROBE	On – Off	On – Off	Off
Pr32	M10 – 05 – 32	Pre-heating time	PREHEAT TIME	Seconds	0 – 250	0
Pr33	M10 – 05 – 33	PELLET CRUISE CONTROL modulation threshold	CRUISE THRESHOLD	°C	120 – 880	540
Pr34	M10 – 05 – 34	Temperature delta on PELLET CRUISE CONTROL modulation threshold	CRUISE DELTA	°C	20 – 60	40
Pr35	M10 – 05 – 35	PELLET CRUISE CONTROL modulation time	CRUISE TIME	Minutes	1 – 10	3
Pr36	M10 – 05 – 36	Time after which the intervention of the Technical Assistance Centre is requested	SERVICE HOURS	Hours	Off 260 – 2800	2000

"RELAX SETTINGS" parameters - Model S80 (L09_161018)						
Parameter	Menu level	Description	Display wording	Measurement	Value field	Database o9
Pr150	M10 – 10 – 01	Heat exchanger 1 (primary) speed during the work phase with "RELAX FUNCTION" enabled	RELAX AIR SPEED	Volt	Off 65 – 225	Off
Pr151	M10 – 10 – 02	"RELAX FUNCTION" activation time	RELAX TIME	Minutes	30 – 254 On	30

Parameter tables SOFT 100

"CLEANER SETTINGS" parameters - Model S100 (L09_161018)						
Parameter	Menu level	Description	Display wording	Measurement	Value field	Database P0
Pr51	M10 – 01 – 01	ON time for brazier cleaning gearmotor	CLEANER DURATION	Seconds	0 – 120	13
Pr52	M10 – 01 – 02	Time from switching off after which the brazier cleaning cycle starts	CLEANER DELAY	Minutes	1 – 15	6
Pr53	M10 – 01 – 03	Time from switching on after which the brazier cleaning cycle starts	CLEANER STAND-BY	Hours	1 – 24	9

"DUCTING SETTINGS" parameters - Model S100 (L09_161018)						
Parameter	Menu level	Description	Display wording	Measurement	Value field	Database P0
Pr55	M10 – 03 – 01	Enables ducting operation	ENABLE DUCT.	Off / Mode	Off S1 – S2 – S1+2 T1 – T2 – T1+2 A1 – A2 – A1+2	A1
Pr56	M10 – 03 – 02	Allows for choosing whether the ducted air fans can be switched "OFF".	DUCTED OFF	On – Off	On – Off	On
Pr57	M10 – 03 – 03	Heat exchanger 2 (ducting 1) in power 1 work phase	DUCT.1 SPEED-S1	Volt	65 – 225	150
Pr58	M10 – 03 – 04	Heat exchanger 2 (ducting 1) in power 2 work phase	DUCT.1 SPEED-S2	Volt	65 – 225	160
Pr59	M10 – 03 – 05	Heat exchanger 2 (ducting 1) in power 3 work phase	DUCT.1 SPEED-S3	Volt	65 – 225	170
Pr60	M10 – 03 – 06	Heat exchanger 2 (ducting 1) in power 4 work phase	DUCT.1 SPEED-S4	Volt	65 – 225	180
Pr61	M10 – 03 – 07	Heat exchanger 2 (ducting 1) in power 5 work phase	DUCT.1 SPEED-S5	Volt	65 – 225	195
Pr62	M10 – 03 – 08	Heat exchanger 3 (ducting 2) in power 1 work phase	DUCT.2 SPEED-S1	Volt	65 – 225	65
Pr63	M10 – 03 – 09	Heat exchanger 3 (ducting 2) in power 2 work phase	DUCT.2 SPEED-S2	Volt	65 – 225	65
Pr64	M10 – 03 – 10	Heat exchanger 3 (ducting 2) in power 3 work phase	DUCT.2 SPEED-S3	Volt	65 – 225	65
Pr65	M10 – 03 – 11	Heat exchanger 3 (ducting 2) in power 4 work phase	DUCT.2 SPEED-S4	Volt	65 – 225	65
Pr66	M10 – 03 – 12	Heat exchanger 3 (ducting 2) in power 5 work phase	DUCT.2 SPEED-S5	Volt	65 – 225	65

"GENERAL SETTINGS" parameters - Model S100 (L09_161018)						
Parameter	Menu level	Description	Display wording	Measurement	Value field	Database P0
Pr38	M10 – 04 – 01	Re-start block	RESTART BLOCK	Minutes	0 – 10	5
Pr39	M10 – 04 – 02	Time for considering the device off	OFF TIME	Minutes	0 – 20	10
Pr40	M10 – 04 – 03	Pre-loading time in ignition	PRE-LOAD START	Seconds	0 – 255	215
Pr41	M10 – 04 – 04	Stand-by time after pre-loading	AFTER PRE-LOAD	Seconds	0 – 255	230
Pr42	M10 – 04 – 05	Extractor speed in pre-loading phase	PRE-LOAD SMOKE SPEED	Rpm	350 – 2800	2300
Pr43	M10 – 04 – 06	Temperature delta on "SET ROOM" for automatic switching on/off	DELTA ON-OFF	°C	0.0 – 10.0	1.0
Pr44	M10 – 04 – 07	Automatic switch-off delay (timer after reaching "SET ROOM")	AUTO OFF DELAY	Minutes	2 – 120	10
Pr45	M10 – 04 – 08	Power change delay	POWER CHANGE	Seconds	0 – 240	60
Pr46	M10 – 04 – 09	Heat exchanger 1 speed (primary) in the switch-off phase	AIR SPEED OFF	Volt	65 – 225	195
Pr47	M10 – 04 – 10	Keypad lock enabling	KEY LOCK	On – Off	On – Off	Off
Pr48	M10 – 04 – 11	Time after which an alarm is triggered in the event of a blackout	BLACK OUT TIME	Seconds	0 – 60	30
Pr49	M10 – 04 – 12	Time after which the "NO PELLET" alarm triggers if "PELLET RESERVE"	ALARM RESERVE	Minutes	1 – 180	60
Pr50	M10 – 04 – 13	Enabling of the pellet level sensor (only on configured models)	PELLET RESERVE	On – Off	On – Off	Off

"FACTORY SETTINGS" parameters - Model S100 (L09_161018)						
Parameter	Menu level	Description	Display wording	Measurement	Value field	Database P0
Pr01	M10 – 05 – 01	Ignition cycle maximum time	START TIME	Minutes	5 – 25	18
Pr02	M10 – 05 – 02	Time for flame stabilisation after ignition	FL. LIGHT TIME	Minutes	0 – 15	9
Pr03	M10 – 05 – 03	Time interval between the two brazier cleaning cycles	CADENCE CLEANING	Minutes	3 – 240	60
Pr04	M10 – 05 – 04	Auger gearmotor ON time in ignition phase	AUGER START	Seconds	0.1 – 8.0	0,8
Pr05	M10 – 05 – 05	Auger gearmotor ON time during the stabilisation phase	AUGER FL. LIGHT	Seconds	0.1 – 8.0	1,2
Pr06	M10 – 05 – 06	Auger gearmotor ON time in power 1 work phase	AUGER POWER 1	Seconds	0.1 – 8.0	2,0
Pr07	M10 – 05 – 07	Auger gearmotor ON time in power 2 work phase	AUGER POWER 2	Seconds	0.1 – 8.0	2,6
Pr08	M10 – 05 – 08	Auger gearmotor ON time in power 3 work phase	AUGER POWER 3	Seconds	0.1 – 8.0	3,2
Pr09	M10 – 05 – 09	Auger gearmotor ON time in power 4 work phase	AUGER POWER 4	Seconds	0.1 – 8.0	4,0
Pr10	M10 – 05 – 10	Auger gearmotor ON time in power 5 work phase	AUGER POWER 5	Seconds	0.1 – 8.0	4,9
Pr11	M10 – 05 – 11	Time after which the alarm is signalled following an anomaly	ALARMS DELAY	Seconds	0 – 120	90
Pr12	M10 – 05 – 12	Brazier cleaning duration	CLEANING DURATION	Seconds	0 – 120	60
Pr13	M10 – 05 – 13	Minimum temperature of the combustion chamber in order to consider the appliance on	MINIMUM THRESHOLD	°C	70 – 280	180
Pr14	M10 – 05 – 14	Maximum temperature of the combustion chamber	MAXIMUM THRESHOLD	°C	200 – 880	800
Pr15	M10 – 05 – 15	Combustion chamber temperature threshold for starting the air exchangers	BLOWER THRESHOLD	°C	100 – 720	180
Pr16	M10 – 05 – 16	Smoke extraction speed in ignition phase	SMOKE SP. START	Rpm	500 – 2800	2100
Pr17	M10 – 05 – 17	Smoke extraction speed in start phase	SMOKE SP. FL. LIGHT	Rpm	500 – 2800	2000
Pr18	M10 – 05 – 18	Smoke extraction speed in power 1 work phase	SMOKE SPEED P1	Rpm	500 – 2800	1600
Pr19	M10 – 05 – 19	Smoke extraction speed in power 2 work phase	SMOKE SPEED P2	Rpm	500 – 2800	1750
Pr20	M10 – 05 – 20	Smoke extraction speed in power 3 work phase	SMOKE SPEED P3	Rpm	500 – 2800	1950
Pr21	M10 – 05 – 21	Smoke extraction speed in power 4 work phase	SMOKE SPEED P4	Rpm	500 – 2800	2150
Pr22	M10 – 05 – 22	Smoke extraction speed in power 5 work phase	SMOKE SPEED P5	Rpm	500 – 2800	2300
Pr23	M10 – 05 – 23	Heat exchanger 1 (primary) speed in power 1 work phase	AIR SPEED P.1	Volt	65 – 225	150
Pr24	M10 – 05 – 24	Heat exchanger 1 (primary) speed in power 2 work phase	AIR SPEED P.2	Volt	65 – 225	160
Pr25	M10 – 05 – 25	Heat exchanger 1 (primary) speed in power 3 work phase	AIR SPEED P.3	Volt	65 – 225	170
Pr26	M10 – 05 – 26	Heat exchanger 1 (primary) speed in power 4 work phase	AIR SPEED P.4	Volt	65 – 225	180
Pr27	M10 – 05 – 27	Heat exchanger 1 (primary) speed in power 5 work phase	AIR SPEED P.5	Volt	65 – 225	195
Pr28	M10 – 05 – 28	Combustion chamber temperature threshold for considering the device off	THRESHOLD OFF	°C	50 – 250	170
Pr29	M10 – 05 – 29	Smoke extraction speed in the brazier cleaning phase	SMOKE SP. CLEANING	Rpm	700 – 2800	2800
Pr30	M10 – 05 – 30	Auger gearmotor ON time in the cleaning phase	AUGER CLEANING	Seconds	0.0 – 8.0	1,0
Pr31	M10 – 05 – 31	Enabling of a primary room temperature probe connected to the board	MOTHERBOARD PROBE	On – Off	On – Off	Off
Pr32	M10 – 05 – 32	Pre-heating time	PREHEAT TIME	Seconds	0 – 250	0
Pr33	M10 – 05 – 33	PELLET CRUISE CONTROL modulation threshold	CRUISE THRESHOLD	°C	120 – 880	560
Pr34	M10 – 05 – 34	Temperature delta on PELLET CRUISE CONTROL modulation threshold	CRUISE DELTA	°C	20 – 60	40
Pr35	M10 – 05 – 35	PELLET CRUISE CONTROL modulation time	CRUISE TIME	Minutes	1 – 10	3
Pr36	M10 – 05 – 36	Time after which the intervention of the Technical Assistance Centre is requested	SERVICE HOURS	Hours	Off 260 – 2800	2000

"RELAX SETTINGS" parameters - Model S100 (L09_161018)						
Parameter	Menu level	Description	Display wording	Measurement	Value field	Database P0
Pr150	M10 – 10 – 01	Heat exchanger 1 (primary) speed during the work phase with "RELAX FUNCTION" enabled	RELAX AIR SPEED	Volt	Off 65 – 225	Off
Pr151	M10 – 10 – 02	"RELAX FUNCTION" activation time	RELAX TIME	Minutes	30 – 254 On	30

WIRING DIAGRAM

COMPONENT KEY:

- M1 = Auger gearmotor
- M2 = Brazier cleaning gearmotor
- V = Primary air fan
- V1 = Ducted 1 air fan (configured models only)
- V2 = Ducted 2 air fan (configured models only)
- C = Spark plug
- A = Smoke extractor with tachometer

SAFETY DEVICES KEY:

- ALp = Fire door closure micro-switch
- ALt = Manual reset thermostat
- ALf = Smoke pressure switch
- ALS = Pallet tank door closing micro-switch

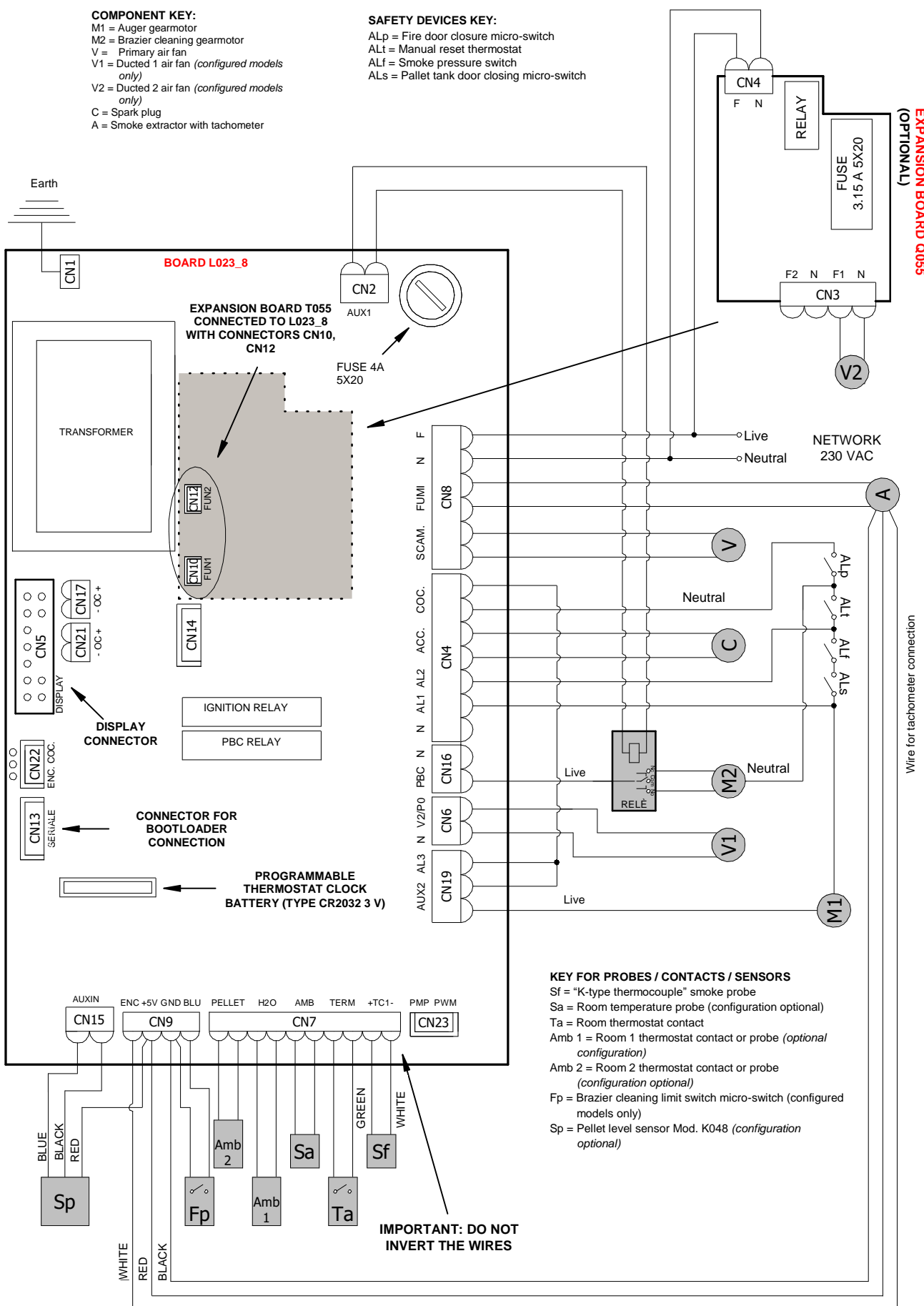

- KEY FOR PROBES / CONTACTS / SENSORS**
- Sf = "K-type thermocouple" smoke probe
 - Sa = Room temperature probe (configuration optional)
 - Ta = Room thermostat contact
 - Amb 1 = Room 1 thermostat contact or probe (optional configuration)
 - Amb 2 = Room 2 thermostat contact or probe (configuration optional)
 - Fp = Brazier cleaning limit switch micro-switch (configured models only)
 - Sp = Pellet level sensor Mod. K048 (configuration optional)

IMPORTANT: DO NOT INVERT THE WIRES

STANDARD WARRANTY CONDITIONS

1. General information

This standard warranty ("**Klover Warranty**") is issued by Klover S.r.l., San Bonifacio, Via A. Volta no. 8, for the products shown on the website www.klover.it (the "**Products**"). The Klover Warranty does not affect the rights provided for by European directive 99/44/EC or by Italian legislative decree no. 206/2005 "Consumer Code", where applicable.

The Klover Warranty is limited to Italy. Klover S.r.l. invites Consumers not based in Italy to contact the dealer from which they bought the Product, to obtain the current warranty conditions.

2. Activation of Warranty

The Klover Warranty must be activated within 60 days from the date of purchase on the website www.klover.it, under the "*Register your warranty*" section. Enter the requested data and attach the delivery note or other tax document proving the purchase (e.g. receipt).

Alternatively, the warranty certificate, which can be found in each Product pack (hereinafter the "**Warranty Certificate**"), must be sent to Klover S.r.l. within the same 60-day term from the date of purchase, by following the instructions on the certificate.

When registering or sending the guarantee, please ensure that the customer's copy of the Warranty Certificate is retained. It must be duly completed and signed by the Consumer and by the installer, together with the delivery note or other fiscally valid document proving the purchase, in order for the Klover Warranty to be valid.

3. Two-year Klover Warranty

The Klover Warranty covers the free repair of the Product and all its constituent parts found to be defective at origin, due to defects that Klover S.r.l. ascertains to be exclusively ascribable to the manufacturer. If the Product cannot be repaired in any way, it will be replaced. In both cases, there will be no change to the date of expiry of the warranty terms valid when the Product was purchased.

The Klover Warranty offers all the advantages of a service guaranteed directly by Klover S.r.l. through its network of authorised technical assistance centres (hereinafter "**TAC**") in Italy. The list can be found on the website www.klover.it. The Klover Warranty will remain valid for 2 years from the date of purchase of the Product, if proven by a delivery note or other fiscally valid document (e.g. receipt), stating the name of the seller, the product purchased and the date of purchase. The Product's components replaced "out of warranty" by the authorised TAC at the Consumer's expense after the two-year warranty period has expired will be guaranteed by Klover S.r.l. for 1 year from the date of replacement, excluding the relevant intervention, labour and ancillary costs.

4. Five-year Klover Warranty

If the initial start-up service is provided by an authorised TAC within 3 months from the date of purchase, the Consumer will be entitled to the Klover Warranty on the "boiler body" for a period of 5 years from the date of purchase.

The cost of the initial start-up service is borne by the Consumer.

This Klover Warranty is valid provided that the periodic maintenance is carried out by the local TAC specified in the user manual (for example, to preserve the boiler bodies with Safe Top, the Long Life protection must be used annually).

The initial start-up report, duly filled in and signed, must be stored carefully to ensure the validity of the Klover Warranty.

5. Complaints and Assistance

As envisaged in (Italian) Legislative Decree no. 24/2002, complaints should be submitted to the retailer through which the Product was purchased.

Once the retailer has checked that the Klover Warranty is in force and has not been invalidated, it will contact the local TAC to agree on the terms of intervention and to eliminate the reported fault. If the Consumer contacts the TAC directly, the assistance centre must immediately inform the retailer from which the Product was purchased.

If, while inspecting the Product, the TAC finds that the reported defect is not among those covered by the Warranty, the call-out and any works completed will be borne by the Consumer.

In order to improve the service and reduce the intervention times, the Consumers must provide the data of the relevant Product. In particular, the following information should be provided: • Warranty Certificate number • the name, model and serial number of the Product • the date of purchase • the reported defect.

Klover S.r.l. will not be held liable for any delays in carrying out repairs on the Product or replacing it.

6. Disclaimer

Klover Products must undergo functional testing before any related masonry works are carried out (for example before tiling, installation of pilasters or painting of the walls). Klover S.r.l. shall not be liable for any costs incurred as a result of

removal and/or reconstruction of related installations, or for any other ancillary intervention even if it is the result of works to replace defective parts.

Klover S.r.l. shall not be held liable for any faults of the Product ascribable to external conditions and/or events including, but not limited to, insufficient plant capacity, incorrect installation, lack of maintenance or maintenance not carried out in accordance with the instructions appearing in the use and maintenance manual, or misuse of the Product. The cost of any works will be borne by the Consumer in such cases.

Klover S.r.l. declines all liability for any damages that may be caused, directly or indirectly, to the Consumer and/or to a third party or to persons, animals or property as a result of failure to comply with all the relevant instructions concerning installation, use and maintenance of the Product. The injured party must prove the loss or damage, the defect and the relative causal connection, and must notify the retailer from which the Product was purchased, pursuant to Legislative Decree no. 24/2002.

7. Exclusions of the Klover Warranty

The Klover Warranty does not include:

- Defects to the Product not ascribable to manufacturing defects
- Defects to the Product related to incorrect or inappropriate installation
- Defects related to improper operation of the flue
- Defects to the Product caused by negligence, accidental breakage, normal wear and tear, tampering and/or damage during transport (scratches, dents etc.), including shipments sent free to destination, works carried out by unauthorised personnel and any additional damage caused by incorrect interventions by the Consumer
- Calibration of settings
- Damages caused by the use of poor or inappropriate fuel
- Transport costs.

The Klover Warranty excludes the following Product components:

- Glass-ceramic or tempered glass, ceramic/majolica tiling and/or coated steel and/or cast iron. Changes in colour shades, speckling, superficial cracking, shading and minor dimensional variations are not considered Product defects, but are characteristics of the artisan manufacturing process
- Painted, chrome-plated or gilded details, handles, ignition heaters
- All the external components of the Product on which the Consumer may intervene directly during use and/or maintenance, or which may be subject to wear and tear and/or the rust build-up, or blemishes on the steel caused by aggressive detergents, in particular the use of wood at a rate that exceeds the recommended hourly capacity, or the use of fuels that were not recommended or were not included in the instructions
- Refractory materials or vermiculite
- The pellet brazier, grille and cast iron cooking plate, the smoke deflector or flame separator, the seals, fuses or batteries in the Product's electronic system and any other removable component that may be subject to normal wear and tear
- Electrical and electronic parts found to be faulty as a result of non-standard electrical connections, natural disasters or voltage variations other than the nominal variation.

8. Competent Court

The Court of Verona shall have sole jurisdiction in the event of disputes.



F U O C O E P A S S I O N E

KLOVER S.r.l.

Via A. Volta, 8
37047 San Bonifacio (VR)
VAT No. 02324280235
www.klover.it