

ENGLISH

Main Revision 2.3
FPS: 001

SMART 80

Pellet boiler cooker

INSTALLATION, USE AND
MAINTENANCE, USEFUL TIPS



Applies to:
SM80
SM80-P (combi boiler with DHW)
SM80-B
SM80-BP (combi boiler with DHW)

KLOVER

F U O C O E P A S S I O N E

SERVICE DECLARATION

Ref. Annex III EU Regulation no. 305/2011

DoP/KLOVER-004

1. Identification number : **SM80**
2. Model and/or lot no. and/or serial no. (Art.11-4) : **SMART 80**
3. Intended use of the product according to the relevant harmonised technical specification : **Home heating appliance fed with wood pellets which can also produce domestic hot water KLOVER s.r.l.**
4. Name or trademark of the manufacturer (Art11-5) : **I - 37047 San Bonifacio (VR) – Via A. Volta, 8**
5. Name and address of the representative (Art.12-2) : **-**
6. Assessment and verification system of the performance constancy (Annex 5) : **System 3**
NB 1880
7. Notified laboratory : **ACTECO s.r.l.**
I - 33084 Cordenons (PN) – Via Amman, 41
- Number of test report (based on System 3) : **1880-CPR-025-15**
8. Declared performances

HARMONISED TECHNICAL SPECIFICATION	EN 14785
PERFORMANCE FEATURES	PERFORMANCE
Fire resistance	A1
Distance from combustible material	200 mm
Fuel spillage risk	Compliant
Emission of combustion products - Nominal power - Reduced power	CO at 13% of O ₂ 0,007 % CO at 13% of O ₂ 0,023 %
Effective temperature	Compliant
Electrical safety	Compliant
Accessibility and cleaning	Compliant
Maximum operating pressure	2,5 bar
Mechanical strength	NPD (performance not determined)
Thermal performance - Nominal power (reduced) - Nominal power (reduced) yielded to the environnr - Nominal power (reduced) yielded to water	22,6 kW (6,7 kW) 3,5 kW (1,2 kW) 19,1 kW (5,5 kW)
Yield - Nominal power - Reduced power	η 88,1 % η 91,4 %
Flue gas temperature - Nominal power - Reduced power	T 210,2 °C T 98,8 °C

9. The performance of the product referred to in points 1 and 2 is compliant with the declared performance in point 8.

This declaration is released on the sole responsibility of the manufacturer referred to in point 4.

Signed in the name and on behalf of the manufacturer by:

San Bonifacio (VR), 22/07/2015

Mario Muraro

Chairman of the Board

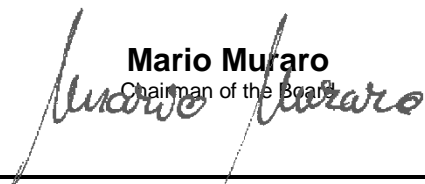

CONTENTS

CONTENTS	1
INTRODUCTION	4
IMPORTANT SAFETY INSTRUCTIONS.....	4
SMOKE CONTROL AREAS.....	5
INSTALLATION REGULATIONS.....	5
CO ALARMS.....	5
CONTROL OF SUBSTANCES HAZARDOUS TO HEALTH.....	6
EXTRACT VENTILATION.....	6
HEARTH.....	6
DISTANCE TO COMBUSTIBLES.....	6
COMBUSTION AIR SUPPLY.....	6
CONNECTION TO THE CENTRAL HEATING SYSTEM.....	6
ELECTRICAL CONNECTIONS.....	6
COMMISSIONING AND HANDOVER.....	7
HEALTH AND SAFETY.....	7
THE MACHINE AND THE PELLETS	7
COMPONENTS OF THE APPLIANCE.....	7
OVERALL DIMENSIONS / CONNECTIONS DATA SHEET (MODEL WITH UPPER FLUE GAS OUTLET).....	11
OVERALL DIMENSIONS / CONNECTIONS DATA SHEET (MODEL WITH REAR FLUE GAS OUTLET).....	12
TECHNICAL SPECIFICATIONS.....	13
PELLET PROPERTIES.....	14
REQUIREMENTS OF THE PLACE OF INSTALLATION	14
POSITIONING.....	14
SPACES AROUND AND ABOVE THE APPLIANCE.....	15
EXTERNAL AIR INTAKE.....	15
THE FLUE PIPE AND CONNECTION TO THE SAME.....	16
CHIMNEY.....	18
ELECTRICAL CONNECTION	19
CONTROL OF ANY COUPLED BOILER.....	20
CONTROL OF A POSSIBLE THREE-WAY MOTORISED VALVE FOR THE DHW SYSTEM (ON SM80-P AND SM80-BP MODELS ONLY).....	20
CONNECTION TO THE ROOM THERMOSTAT.....	21
PLUMBING CONNECTIONS	22
THE DISPLAY	23
THE MENU	25
INITIAL START-UP	29
FILLING THE SYSTEM FOR THE FIRST TIME.....	29
PELLET LOADING AND CONNECTION TO THE MAINS POWER SUPPLY.....	30
IGNITION CYCLE.....	30
WORKING MODE FROM POWER 1 TO POWER 5.....	31
WORKING MODE AT SANITARY POWER (IN PRE-SET MODELS ONLY).....	31
WORKING MODE IN COOKING PLATE / OVEN OUTPUT.....	31
SWITCH-OFF CYCLE.....	32
CHANGING THE WORKING POWER.....	33
CHANGING THE ROOM AND WATER TEMPERATURE.....	33
PROBLEMS, ALARMS, USEFUL ADVICES	34
USEFUL INFO.....	34
WHAT HAPPENS IF.....	34
ALARM SIGNALS.....	35
CLEANING AND MAINTENANCE	36
PRECAUTIONS BEFORE CLEANING.....	36
ROUTINE CLEANING.....	36
NON-ROUTINE CLEANING.....	37

YEARLY CLEANING	38
CLEANING THE CERAMIC GLASS	39
CLEANING THE COOKING PLATE	39
CLEANING THE FLUE PIPE	40
MAINTENANCE	40
PCB PARAMETERS	41
WIRING DIAGRAM	43
WARRANTY CONDITIONS	44

Dear Customer,

First of all we would like to thank you for choosing a “KLOVER” product and we hope you will be satisfied with this product.

Please read the warranty certificate carefully. This is found on the last page of this *User Guide*. Please contact the authorised Technical Assistance Centre (TAC) for the initial start-up of your stove and to validate the warranty.

We would like to thank you again for trusting KLOVER products, and we would also like to inform you that these models are the result of forty years of experience in the manufacture of solid fuel products using water as a heat transfer medium.

Every single detail of the product is manufactured by qualified staff, using the most advanced equipment.

The manual contains a detailed description of the appliance and its operation, instructions for proper installation, basic maintenance and control points, which must be periodically performed; furthermore it contains practical advice which helps to obtain maximum performance from the appliance with minimum fuel consumption.

Stay warm with KLOVER!

Technical Support

Klover pellet appliance is imported and distributed by Firepower Heating, Flightway, Dunkeswell, Honiton, Devon, EX14 4RD.

UK technical and product support is provided by Firepower Heating who can be reached on 0844 3320156.



Certificate number : KIWA0007/025 B – KIWA0007/026 B – KIWA0007/027 B – KIWA0007/028 B

Copyright

All rights reserved. The reproduction of any part of this manual, in any form, without the explicit written permission of KLOVER Srl is forbidden. The content of this manual may be modified without notice. Although the documentation contained in this manual has been carefully compiled and checked, KLOVER srl cannot be held liable for any damages arising from the use of the same.

Copyright © 2016 KLOVER srl

INTRODUCTION

Important safety instructions

Please read these instructions before installing and using the product.

- The installation and initial start-up of the appliance must be performed by skilled personnel trained in the relevant safety standards. They will be responsible for the definitive installation of the appliance and its proper operation. KLOVER srl shall not be held liable if these precautions are not observed.
- During installation of the appliance, all local regulations - including those referring to national and European Standards - must be observed.
- Connect the flue gas outlet to a flue with the specifications described in the "Flue and its connection" section of this User guide.
- The appliance is not suitable for installation on a shared flue system.
- If the flue should catch fire, use appropriate fire extinguishing equipment or call the fire brigade.
- Connect the product to an earthed power socket. Avoid using sockets controlled by switches or automatic timers.
- Do not use the power supply cable if damaged or worn.
- If a multiple socket is used, make sure that the total current draw of the connected devices does not exceed the rated current draw for the socket. Also make sure that the total current draw of all the devices connected to the socket does not exceed the maximum permitted level.
- Do not use flammable substances to clean the appliance or its parts.
- Do not leave flammable containers and substances in the place where the appliance is installed.
- The appliance works exclusively with wood pellets and only with the hearth door shut.
- NEVER open the door of the appliance during normal operation.
- The use of poor quality pellets or any other material can damage the appliance operation, voiding the warranty and exempting the manufacturer from all liability.
- Do not use the appliance as an incinerator or for any use other than that for which it was designed.
- Do not use fuels other than those recommended.
- Do not use liquid fuels.
- The appliance, and its outer surfaces in particular, become very hot to the touch during operation; handle with caution in order to avoid burns.
- Only use original spare parts recommended by the manufacturer.
- Do not make any unauthorised modifications to the appliance.
- Do not touch the hot components of the product (ceramic glass, flue pipe) during normal operation.
- Never touch the appliance if you are barefoot and/or if you have wet or damp parts of the body.
- Use the appropriate button to switch off the electrical panel. Do not disconnect the power supply cable while the appliance is operating.
- During the ignition phase and normal operation of the appliance, maintain the necessary safety distance and do not remain standing in front of it.
- Keep children away from the appliance when it is running since they could get burned by touching its hot components.
- Do not leave the packaging elements within reach of children or unassisted disabled persons.
- Children and inexperienced people must not be allowed to use the appliance.
- Do not use the appliance in ways other than those indicated in this user guide.
- The appliance is designed for indoor use only.
- This user guide constitutes an integral part of the appliance. If the product is sold to another user, this manual must be passed on to the new owner.
- The Smart 80/120 is a pellet boiler. The ability to cook is purely an incidental by-product of the production of heat when the boiler is in demand (see also "Working mode in Cooking plate / Oven output").
- During normal use the over door on the Smart 120 and the combustion chamber door on the Smart 80 and 120 become excessively hot. To avoid accidental contact and burns the use of a fireguard conforming to BS EN 8423:2010+A1:2016 (Fireguards for fires and heating appliances for domestic use. Specification) is essential.

KLOVER S.R.L. DECLINES ALL LIABILITY IN CASE OF ACCIDENTS DUE TO FAILURE TO COMPLY WITH THE SPECIFICATIONS OF THIS MANUAL.

KLOVER S.R.L. DECLINES ALL LIABILITY DUE TO INCORRECT USE OF THE PRODUCT BY THE USER, UNAUTHORISED MODIFICATION AND/OR REPAIRS, AND USE OF NON-ORIGINAL SPARE PARTS OR SPARE PARTS NOT SPECIFICALLY DESIGNED FOR USE ON THIS PRODUCT MODEL.

KLOVER S.R.L. SHALL NOT BE HELD LIABLE FOR THE STOVE'S INSTALLATION. THE INSTALLER IS THE SOLE PARTY RESPONSIBLE FOR THIS OPERATION AND IS ALSO ENTRUSTED WITH CHECKING THE FLUE, EXTERNAL AIR VENT AND THE CORRECTNESS OF THE PROPOSED INSTALLATION SOLUTIONS. ALL THE SAFETY REGULATIONS SET OUT IN THE SPECIFIC LAWS IN FORCE IN THE COUNTRY OF THE STOVE'S INSTALLATION MUST BE OBSERVED.

NON-ROUTINE MAINTENANCE MUST ONLY BE PERFORMED BY AUTHORISED AND QUALIFIED STAFF.

To ensure the validity of the warranty, the user must comply with the instructions contained in this guide and, in particular, must:

- Use the appliance within its operating limits;
- Regularly perform all maintenance activities;
- Authorise expert and competent people to use the appliance.

Failure to comply with the instructions contained in this guide shall automatically void the warranty.

Smoke Control Areas

Under the Clean Air Act local authorities may declare the whole or part of the district of the authority to be a smoke control area. It is an offence to emit smoke from a chimney of a building, from a furnace or from any fixed boiler if located in a designated smoke control area. It is also an offence to acquire an "unauthorised fuel" for use within a smoke control area unless it is used in an "exempt" appliance ("exempted" from the controls which generally apply in the smoke control area).

The Secretary of State for Environment, Food and Rural Affairs has powers under the Act to authorise smokeless fuels or exempt appliances for use in smoke control areas in England. In Scotland and Wales this power rests with Ministers in the devolved administrations for those countries. Separate legislation, the Clean Air (Northern Ireland) Order 1981, applies in Northern Ireland. Therefore it is a requirement that fuels burnt or obtained for use in smoke control areas have been "authorised" in Regulations and that appliances used to burn solid fuel in those areas (other than "authorised" fuels) have been exempted by an Order made and signed by the Secretary of State or Minister in the devolved administrations.

Further information on the requirements of the Clean Air Act can be found here: <http://smokecontrol.defra.gov.uk/>
Your local authority is responsible for implementing the Clean Air Act 1993 including designation and supervision of smoke control areas and you can contact them for details of Clean Air Act requirements"

"The Klover SMART 80 (models – SM80, SM80-BP, SM80-P, SM80-B) have been recommended as suitable for use in smoke control areas when burning wood pellets."

Installation Regulations

These operating and instructions cover the basic principles to ensure the correct installation of the pellet appliance, although particulars may need modification to reflect local site conditions. In all cases the installation must comply with current Building Regulations, Local Authority By-laws and other regulations that affect the installation of the appliance. The Building Regulations requirements can be met by adopting the relevant recommendations given in British Standards BS 8303, BS 6461 and BS 7566 as an alternative means to achieve an equivalent level of performance to that obtained by following the guidance given in Approved Document J.

Please note that it is a legal requirement under England and Wales Building Regulations that the installation of the stove is carried out under Local Authority Building Control approval or is installed by a Competent Person registered with a Government approved Competent Persons Scheme. HETAS Ltd operate such a Scheme and a listing of their Registered Competent Persons can be found on their website at www.hetas.co.uk.

CO Alarms

Building Regulations require that when a fixed solid fuel or wood/biomass appliance is installed in a dwelling a carbon monoxide alarm must be fitted in the same room as the appliance, we would also recommend that a Carbon Monoxide

alarm is fitted in any room through which the flue or chimney passes. Further guidance on the installation of the carbon monoxide alarm is available in BS EN 50292:2002 and from the alarm manufacturer's instructions. Provision of an alarm must not be considered a substitute for either installing the appliance correctly or ensuring regular servicing and maintenance of the appliance and chimney system.

Control of Substances Hazardous to Health

Some types of fire cement are caustic and should not be allowed to come into contact with the skin. In case of contact wash immediately with plenty of water or follow the COSHH assessment issued by the manufacturer of the product. This stove contains no asbestos. If there is a possibility of disturbing any asbestos in the course of installation then please seek specialist guidance and use appropriate protective equipment. When installing or servicing this boiler care should be taken to avoid the possibility of personal injury and any suitable personal protective equipment must be worn.

Extract ventilation

There must not be an extractor fan fitted in the same room as the boiler as this can cause the boiler to emit fumes into the room.

Hearth

The hearth should be able to accommodate the weight of the stove, which is given in the instruction manual. The boiler should always be installed on a non-combustible hearth of a size and construction that is in accordance with the provisions of the current Building Regulations Approved Document J.

Distance to combustibles

The clearance distances to combustible material beneath, surrounding or upon the hearth and walls adjacent to the hearth should comply with the guidance on the separation of combustible material given in Building Regulations Approved Document J and also in these stove instructions.

Combustion air supply

For the stove to perform efficiently and safely there must be an adequate air supply to the room in which the stove is installed to provide combustion air. The provision of air supply to the stove must be in accordance with current Building Regulations Approved Document J.

Connection to the central heating system

Ensure the heating system is correctly designed for the boiler. Full guidance is given in the main installation manual. Depending on the intended design of the heating installation and also on the output of the boiler, the central heating system must be in accordance with either: BS EN 14336:2004: Heating Systems in Buildings. Installation and commissioning of water based heating systems. BS EN 12828: 2003; Heating Systems in Buildings. Design of water based heating systems. BS EN 12831: 2003; Heating Systems in Buildings. Method for calculation of the design heat load.

Particular attention must be paid to the installation and correct functioning of any Thermal Safety Device where necessary.

Electrical connections

The installation of any electrical services during the installation of this boiler and the associated heating system must be carried out by a registered competent electrician and in accordance with the requirements of the latest issue of BS 7671.

Commissioning and handover

Before commissioning this boiler be sure to read and follow the operation manuals to ensure that everything is carried out in accordance with the correct procedures.

Ensure any loose parts are fitted in accordance with the instructions, ensure any packing pieces are removed from the stove prior to installation.

Once the stove is under fire check all seals for soundness and that the boiler and water system are operating correctly. Ensure that the flue is functioning correctly and that all products of combustion are vented safely to atmosphere via the chimney terminal.

On completion of the installation and commissioning ensure that the instruction manuals for the boiler are left with the customer. Ensure to advise the customer on the correct use of the appliance with the fuel likely to be used on the boiler and warn them to use only the recommended fuel for the boiler. The user should be given a demonstration of the required routine maintenance and safety checks. Remind the user of the importance of regular chimney sweeping and servicing by qualified persons to ensure continued safe operation of the boiler. Leave the boiler operational and inform the user that this is the case.

Health and Safety

Care must be taken when installing a Klover pellet appliance to ensure that the requirements of the Health and Safety at Work Act are met.

Adequate Handling facilities must be available for loading, unloading and site handling the appliance bearing in mind the weight of the appliance.

THE MACHINE AND THE PELLETS

Components of the appliance

The table below shows the standard features of the appliance:

Expansion tank	8 lt
Safety valve	2,5 bar
Pressure gauge	0 – 4 bar
Check valve	Yes
Manual air vent valve	Yes
Heating system pump	Yes. Mod.25/70
DHW heat exchanger	On SM80-P and SM80-BP models only
System load connection with cock	Yes
Electrical setting for the connection of the domestic water flow switch	Yes

The appliance is delivered with the following equipment:

- No. 1 user, installation and maintenance guide;
- No. 1 power supply cable;
- No. 1 key for opening technical compartment;
- No. 1 swab D.65-300 mm L.450 mm.

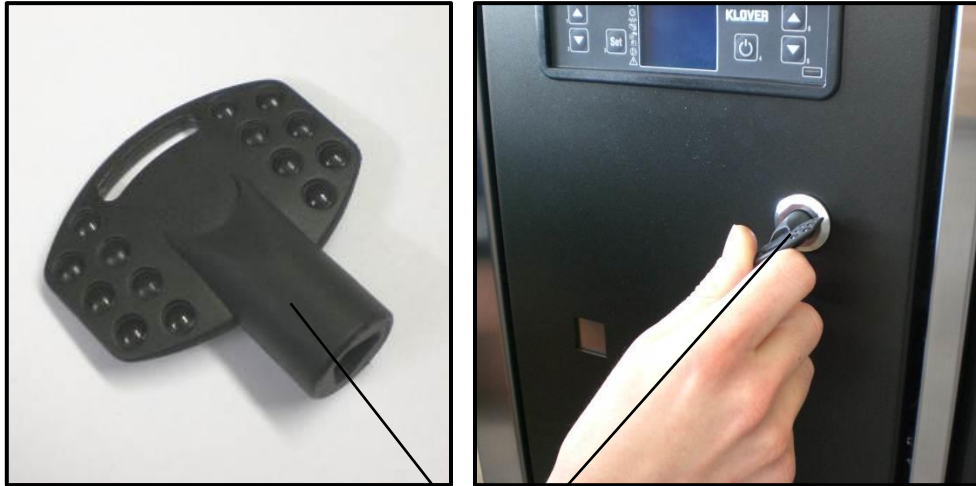

Key for opening technical compartment.



FRONT LEFT TECHNICAL COMPARTMENT

Safety thermostat with manual reset.

Main switch ON/OFF.

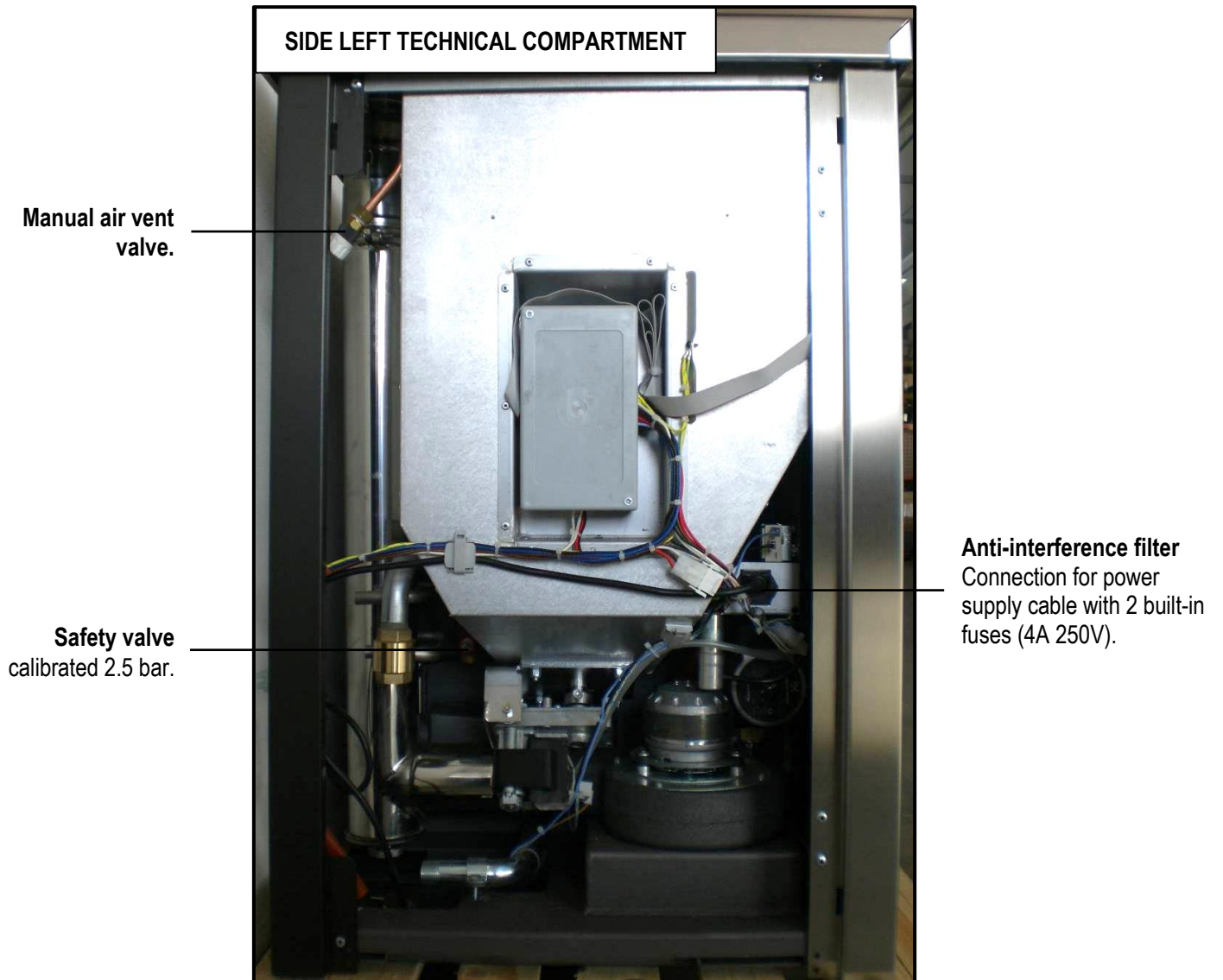

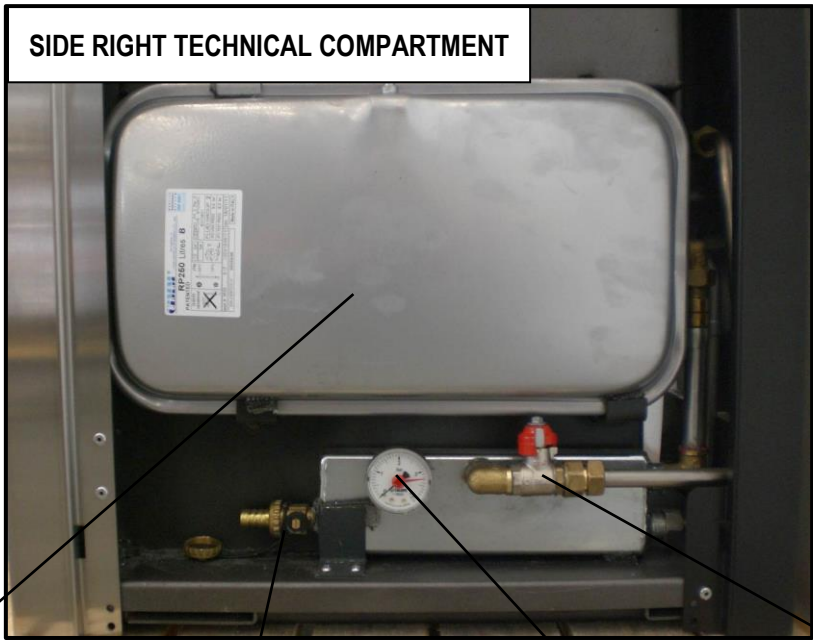

SIDE RIGHT TECHNICAL COMPARTMENT

Expansion tank
8 l with pre-load 1 bar.

Boiler body and system drain cock.

Manometer
(indicates the pressure of the heating system).

System load and boiler body.

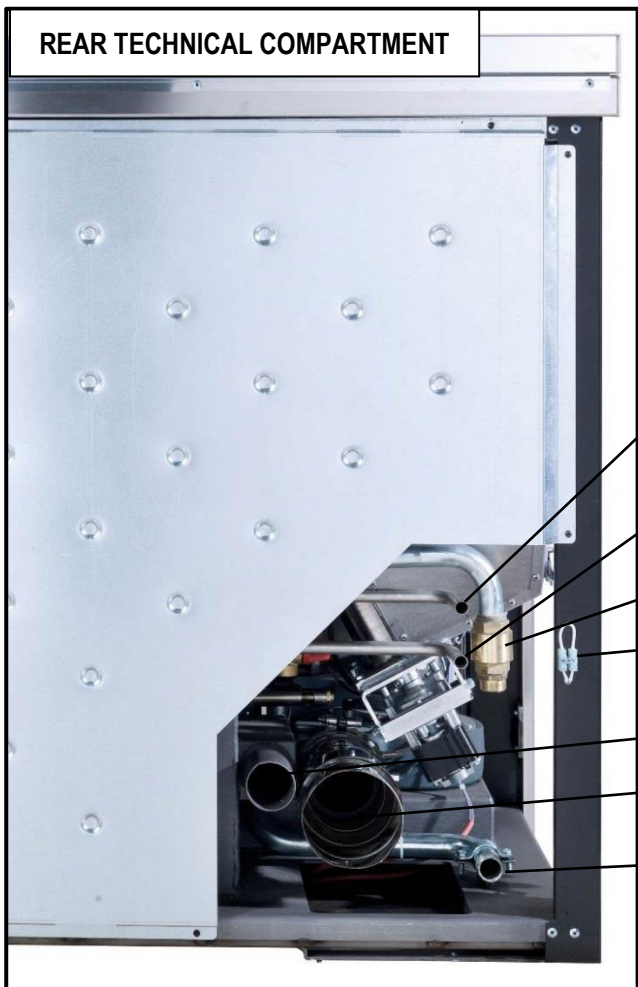

REAR TECHNICAL COMPARTMENT

Domestic hot water outlet pipe connection (on SM80-P and SM80-BP models only).

Domestic cold water inlet pipe connection (on SM80-P and SM80-BP models only) + **system load and boiler body.**

Heating system flow with check valve.

Terminal for room thermostat connection.

Combustion air inlet.

Flue gas outlet.

Heating system return.

Overall dimensions / Connections data sheet (Model with upper flue gas outlet)

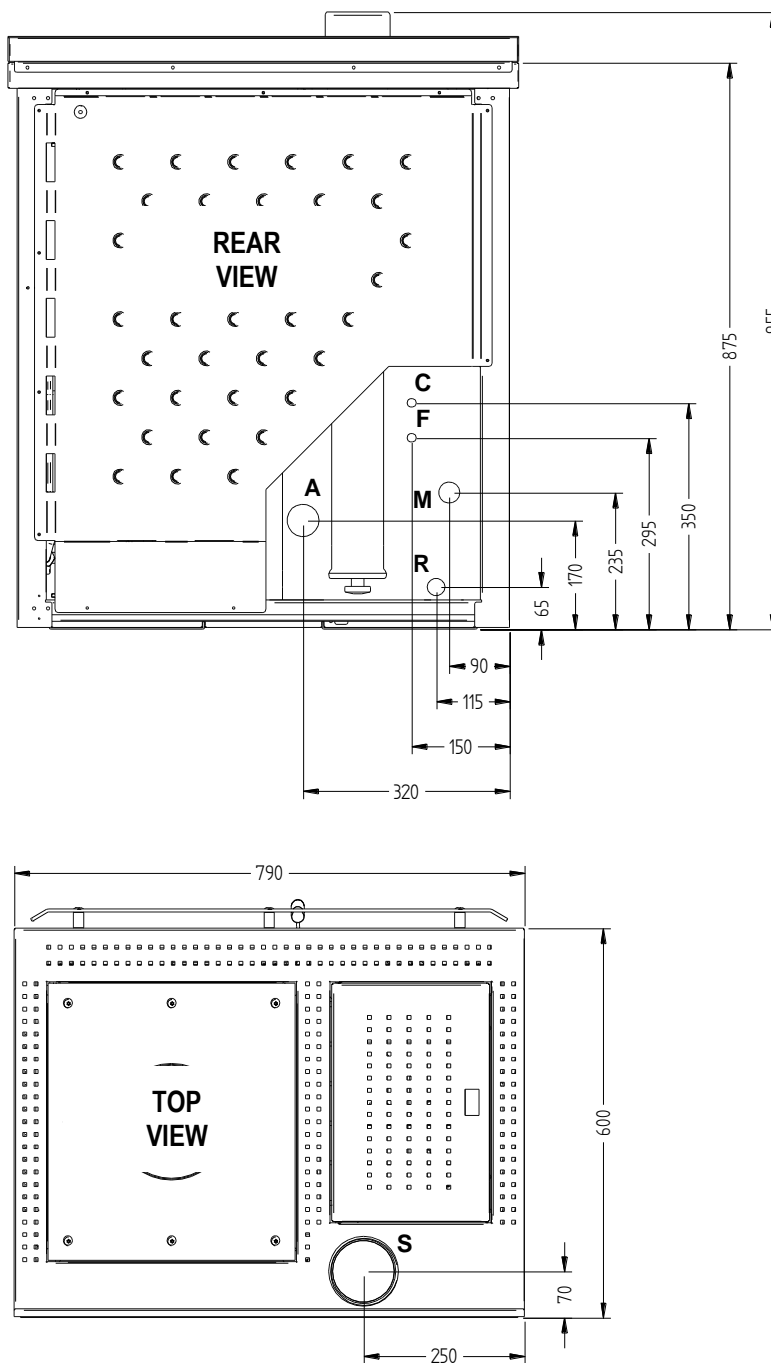

Description of connections

M = Heating system flow	3/4" F
R = Heating system return	3/4" M
F = Domestic cold water inlet (on SM80-P and SM80-BP models only) + system load and boiler body	14 mm
C = Domestic hot water outlet (on SM80-P and SM80-BP models only)	14 mm
A = Combustion air inlet	50 mm
S = Flue gas outlet	100 mm M

Overall dimensions / Connections data sheet (Model with rear flue gas outlet)

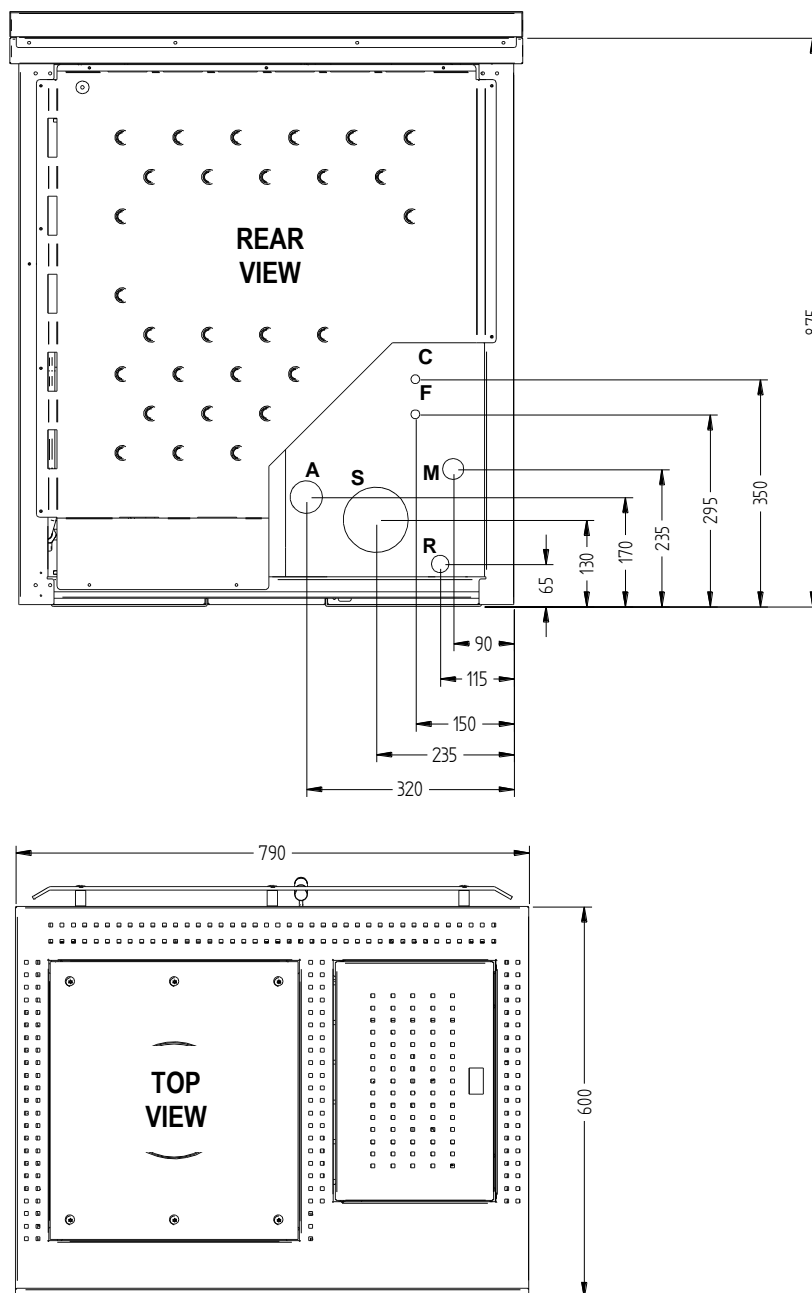

Description of connections

M = Heating system flow	3/4" F
R = Heating system return	3/4" M
F = Domestic cold water inlet (on SM80-P and SM80-BP models only) + system load and boiler body	14 mm
C = Domestic hot water outlet (on SM80-P and SM80-BP models only)	14 mm
A = Combustion air inlet	50 mm
S = Flue gas outlet	100 mm M

Technical Specifications

Nominal heat input	kW (Kcal/h)	25,7 (22.100)
Reduced thermal capacity	kW (Kcal/h)	7,4 (6.400)
Nominal thermal output	kW (Kcal/h)	22,6 (19.400)
Reduced thermal power	kW (Kcal/h)	6,8 (5.800)
Nominal power released to heating water	kW (Kcal/h)	19,1 (16.400)
Reduced power released to heating water	kW (Kcal/h)	5,5 (4.700)
Nominal power delivered to room due to radiation	kW (Kcal/h)	3,5 (3.000)
Reduced power delivered to room due to radiation	kW (Kcal/h)	1,2 (1.000)
Efficiency at thermal nominal power	%	88,1
Efficiency at reduced thermal power	%	91,4
CO at 13% oxygen at nominal thermal power	%	0,007
CO at 13% oxygen at reduced thermal power	%	0,023
Power consumption min - max	Watt	25 – 300*
Nominal voltage	V	220
Nominal frequency	Hz	50
Expansion vessel litres/preloading bar		8 / 1
Maximum operating/recommended pressure	bar	2,5 / 1,5
Flue pipe diameter	mm	100
Air intake pipe diameter	mm	50
Minimum chimney draught at nominal thermal power	Pa	12,1
Minimum chimney draught at reduced power	Pa	10
Combustion gas mass at nominal thermal power	g/s	13,3
Combustion gas mass at reduced power	g/s	7,4
Pellet tank capacity	Kg	32
Average exhaust flue gas temperature at nominal thermal power	°C	210,2
Average exhaust flue gas temperature at reduced power	°C	98,8
Boiler body capacity	litres	28
Width	mm	790
Height	mm	880
Depth	mm	600
Minimum safety distance from flammable materials	mm	200
Weight	Kg	235

* Power consumption only during the ignition cycle.

The appliance's heat output may vary depending on the type of pellets used.

Pellet properties

The appliance has been tested with all types of pellets available on the market. The pellets must have the following properties:

- Diameter 6 mm.
- Maximum length 35 mm.
- Maximum humidity content 8 – 9 %.
- 100% wood. Totally additive-free.
- Maximum ash residue 1.1 %.

To obtain good performance from the appliance, we recommend using good quality pellets. **Pellets should be poured into the tank using a shovel, and not directly from the bag.**

Good quality pellets should have the following properties:

- Constant diameter cylinders with a smooth, shiny surface;
- There should not be a lot of sawdust inside the packaging;
- After grabbing a bunch of pellets and placing them into a container filled with water, good-quality pellets will sink and poor-quality ones will tend to float;
- The quality certification data, in particular conformity to international standards such as EN14961-2, DIN 51731 and O-NORM M7135, should be indicated on the packaging;
- The packages should be intact since pellets tend to absorb humidity. Humidity not only reduces the calorific value and increases the amount of flue gases expelled, but also causes swelling of the product which may create problems with the appliance.

The production of pellets must be compliant with some international standards (such as EN14961-2, DIN 51731 and O-NORM M7135) which establish minimum values for quality checks on pellets. To facilitate the right choice of the combustible material you can find below one of the most common certification marks identifying the quality of the pellets:

Indication of the standard,
base reference for the quality
classes ENplus

**Indication of the quality
class of the certified pellet**
(preferable A1)



IT xxx

Code of the certified company
consisting of two elements:

- Symbol of the country of production (example "IT")
- Progressive number assigned at the acquisition of the certification (example "xxx")

The use of poor quality pellets or any other material can damage the appliance operation, voiding the warranty and exempting the manufacturer from all liability.

In order to guarantee trouble-free combustion, the pellets must be stored in a dry place.

REQUIREMENTS OF THE PLACE OF INSTALLATION

Positioning

The initial phase for best installation of the appliance is to determine its optimum location; the following elements need to be considered:

- The possibility of creating an external air vent;
- The possibility of creating a straight flue, preferably coaxial to the outlet of the appliance;
- Proximity to the main water drain and/or the boiler (if one already exists);
- Proximity or ease of connection to the water system;
- Ease of access for cleaning the appliance, the flue gas exhaust pipes and the flue.

The unit must be installed on a floor with a suitable load capacity. If the existing building does not fulfil this requirement appropriate measures (e.g. load distribution plate) must be taken.

The minimum safety distance from flammable materials must be at least 200 mm from the sides and back of the appliance.

Relocating the appliance should not be done by forcing on the handle, glass or ceramics.

The installation must guarantee easy access for cleaning the appliance, the flue gas exhaust pipes and the flue, and any subsequent maintenance operation by the Authorised technical assistance centre.

Once you have found the best location for the appliance, position it following the instructions given below.

Spaces around and above the appliance

The figure below shows the minimum distances from walls or other not-easily-removable furniture, that need to be taken into consideration when positioning the appliance.

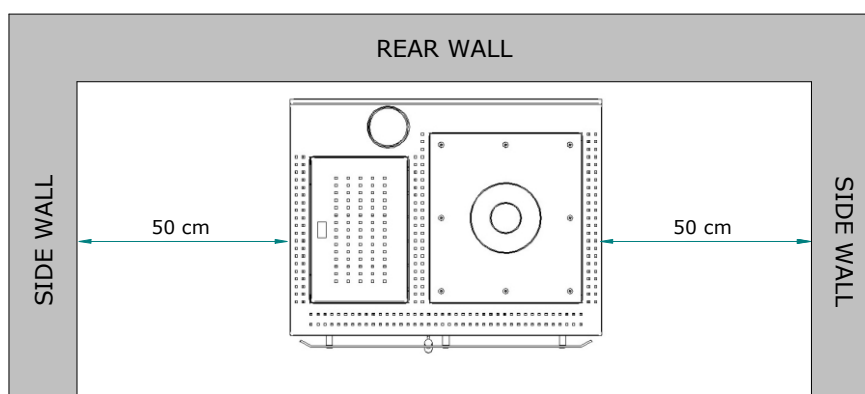

The hood assembled above the central heating cooker must be at least 70 cm away from its upper part (also see technical features in the instructions manual attached to the hood to be installed).

Any shelves or false ceilings mounted above the appliance must be at least 70 cm away from the top part of it.

Furniture and movable objects must be positioned at least 10 cm from the side surfaces of the appliance; these objects must be moved when performing maintenance on the appliance.

Protect all structures that can catch fire against the radiated heat of the fire.

Any extra intervention by the Authorised technical assistance centre, where it is necessary to disconnect the device from the system, will not be recognised under warranty as described in chapter "Warranty Conditions".

External air intake

During operation, the appliance takes in air from the environment in which it is installed; It is therefore essential that this air is replaced through an external air vent. The absence of the air vent may affect the flue draught and therefore the combustion and the safety of the appliance.

Therefore **it is mandatory** to install an external air vent with a minimum completely free passage of **at least 80 cm²** (round hole with minimum diameter of 15 cm protected with a special fixed large mesh grid).

If the wall behind the appliance is on the outside, we recommend you make the hole near it at about 20 cm above the ground (see example in Fig. A).

If it is not possible to put an air vent in the wall behind the appliance, make a hole in a perimeter wall in the room where it is installed. If it not possible to put the external air vent in the same room as where the appliance is installed, this hole can be made in an adjoining room as long as this room communicates permanently, by means of a transit hole (15 cm minimum diameter).

The hole must be protected externally with a fixed grille. The protective grille must be checked periodically to ensure that it is not obstructed, thereby impeding the passage of air. **Therefore keep the air vents clear of obstructions.**

Do not connect the external air vent directly to the appliance through piping. If there are other heating or extraction devices inside the room, the air vents must guarantee a sufficient amount of air for properly operating all the devices.

Only sealed appliances or appliances that do not cause a lower pressure compared with the external environment can pre-exist or be installed in the place where the appliance is installed.

Extractor fans can cause malfunctions to the appliance if used in the same room.



Figura A

Chimney and Flue pipe

The chimney is essential to the efficient operation of a Klover appliance. The chimney should be designed and constructed according to these instructions, and relevant regulations including Building Regulations Approved Document J.

Shape and size of chimney: A round chimney of 125mm diameter is recommended. 125mm is also the minimum diameter which should be used. If the appliance is DEFRA Exempt then it should be connected to a 125mm chimney as standard (assuming that the outlet is not larger than 125mm). If it is not DEFRA Exempt then a calculation according to BS EN 13384-1:2002 must be completed if it is to be connected to a 125mm diameter chimney.

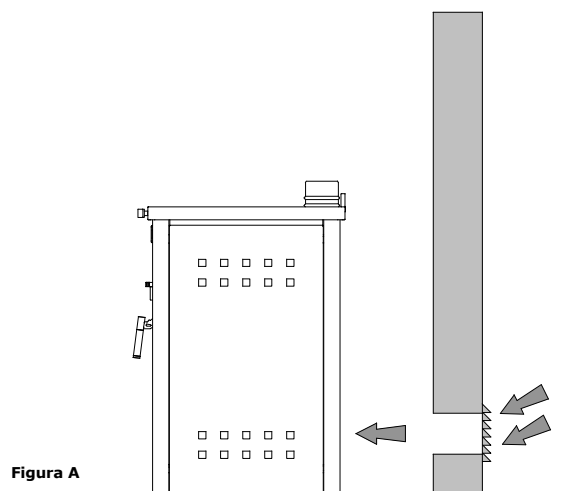
The maximum recommended round chimney diameter is 150mm.

Square or rectangular cross-sections must have rounded corners with radius not less than to 20 mm Rectangular cross-sections must have a maximum ratio of 1.5 between the sides.

The chimney must have a constant, and unobstructed, internal cross section

Under no circumstances should the chimney be of a smaller diameter than the appliance outlet.

Connecting flue pipe: Short runs of single skin flue pipe to connect to the chimney may be run in a (minimum) diameter of 100mm (as long as this is not smaller than the appliance outlet).

Existing chimneys: Existing masonry chimneys should be lined with flexible stainless steel liner and the liner should be insulated. All connections must be appropriately sealed.

Existing chimneys must be inspected, be clear of obstruction and have been swept clean immediately before installation of the lining system.

No shared chimneys: Each appliance must connect to its own flue. No other appliance must connect to the same flue or chimney. No other pipes or conduits must pass through the chimney or flue.

Sealed joints and connections: The appliance works with the combustion chamber in negative pressure and the flue pipe under positive pressure; it is essential that all joints and flue and chimney connections are sealed. Single skin and twin wall flue pipe should incorporate silicone seals at each joint. Other connections should be sealed with a suitable sealant (for example high temperature silicone). All seals must be able to withstand 250°C or more.

Suitable materials: Flue and chimney products used, including fixings and components, must be made of suitable, non-combustible materials conforming to the applicable regulations.

Aluminium and fibre cement pipes are forbidden.

Orientation and initial vertical rise: The flue system should run as vertically as possible as any deviations off the vertical can adversely affect the draw. 45° is the maximum off-vertical angle than may be used. Non-vertical sections should make up no more than ¼ of the effective height of the flue or chimney (measured from the appliance outlet to the top of the chimney), and must not be longer than 2,000 mm.

There should be no more than 4 bends in the system, with a tee counting as 2 bends.

Securely fix and support the system to avoid vibration and movement.

90° bends should not be used. When using the rear outlet on the appliance a 90° tee should be used with sweeping access and debris collection space.

When using the rear outlet any horizontal run should not exceed 150mm, including the arm of the tee.

An initial vertical run of 600mm from the appliance is recommended before any change in direction.

Cleaning Access: The system must provide access so that the entire system can be swept and cleaned.

Flue pipes must not pass through rooms in which the installation of combustion devices is prohibited.

IT IS STRICTLY FORBIDDEN TO INSTALL FLUE DAMPERS/BUTTERFLY VALVES.

Heat shielding: If combustible materials are present then minimum separation distances will need to be adhered or heat shielding will be required. Please refer to Building Regulations Approved Document J, and also these installation instructions.

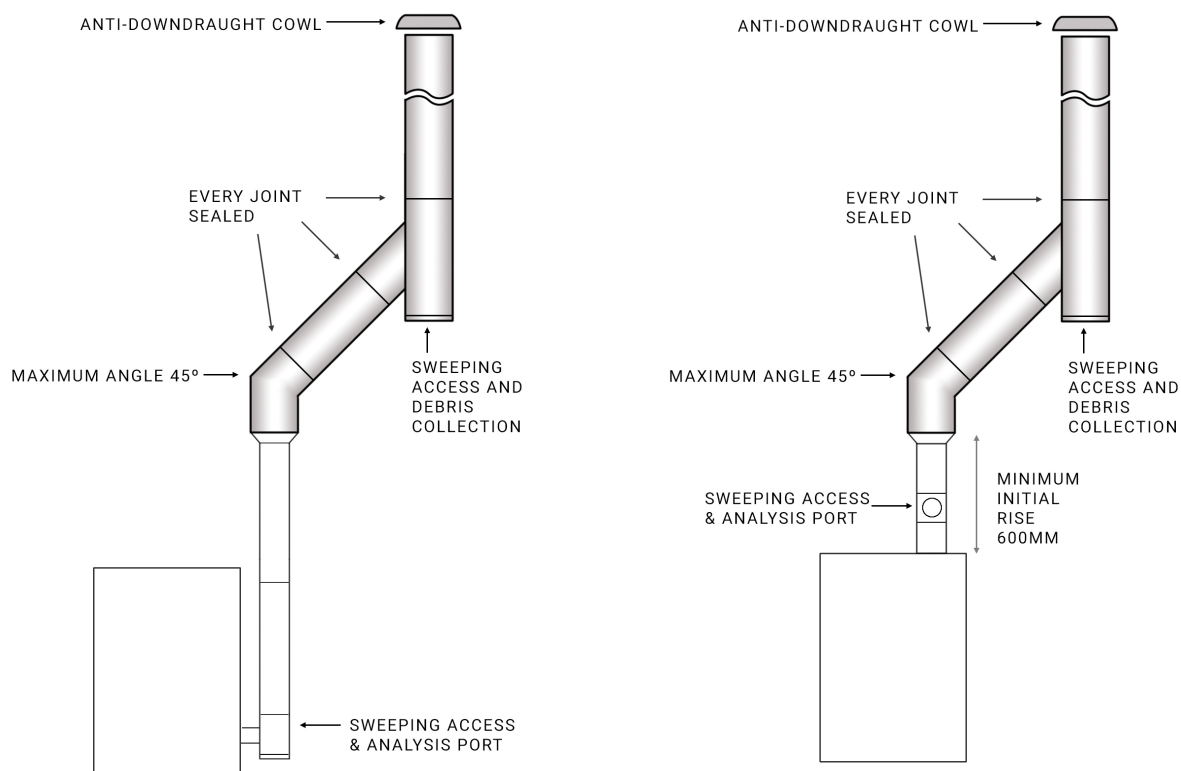

Height and draught: In order for the appliance to perform satisfactorily the chimney height must be sufficient to ensure a draught of 12 Pa so as to clear the products of combustion and prevent smoke problems into the room. A chimney height of not less than 4.5 m measured vertically from the outlet of the stove to the top of the chimney should be satisfactory. Alternatively the calculation procedure given in BS EN 13384-1:2002 may be used as the basis for deciding whether a particular chimney design will provide sufficient draught.

The outlet from the chimney should be above the roof of the building in accordance with the provisions of Building Regulations Approved Document J diagram 17 or 18. Please see the diagram below.

Point where flue passes through weather surface (Notes 1, 2)	Clearances to flue outlet
A At or within 600mm of the ridge	At least 600mm above the ridge
B Elsewhere on a roof (whether pitched or flat)	At least 2300mm horizontally from the nearest point on the weather surface and: a) at least 1000mm above the highest point of intersection of the chimney and the weather surface; or b) at least as high as the ridge.
C Below (on a pitched roof) or within 2300mm horizontally to an openable rooflight, dormer window or other opening (Note 3)	At least 1000mm above the top of the opening.
D Within 2300mm of an adjoining or adjacent building, whether or not beyond the boundary (Note 3)	At least 600mm above any part of the adjacent building within 2300mm.
Notes 1) The weather surface is the building external surface, such as its roof, tiles or external walls. 2) A flat roof has a pitch less than 10°. 3) The clearances given for A or B, as appropriate, will also apply. 4) A vertical flue fixed to an outside wall should be treated as equivalent to an inside flue emerging at the nearest edge of the roof.	

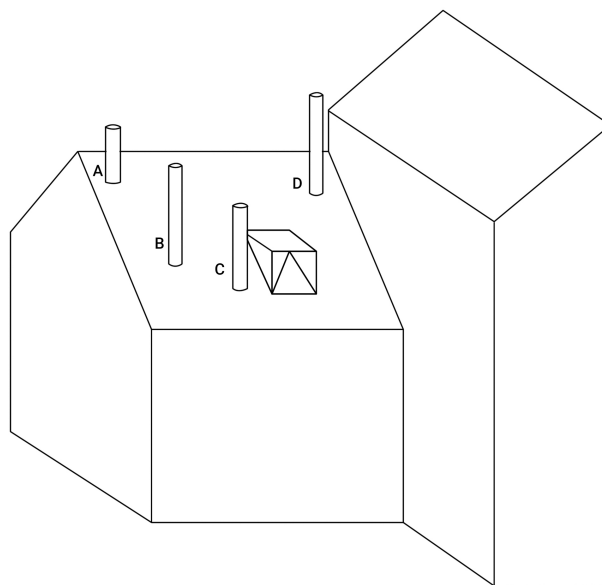

Termination/Cowl: The cowl terminates the chimney and it is recommended that an effective anti-downdraft cowl should always be used. It must have a usable outlet cross-section no less than double that of the flue onto which it is inserted. It must prevent rainwater or snow entry. It must ensure the discharge of combustion by-products even in the event of winds from every direction and inclination.

ELECTRICAL CONNECTION

The electric connection must only be performed by **qualified personnel** only, and all work must be in accordance with Building Regulations Part P and any other appropriate standards.

Check that the power supply voltage and frequency correspond to 220V – 50 Hz.

Product safety is only obtained when it is correctly connected to a suitable earthing system.

In the electric connection to the mains power supply, include a 6 A – Id 30 mA differential trip-switch with suitable breaking load. The electric connections, including the earth connection, must be made after shutting off the electrical system.

When completing the system, bear in mind that the cables must be laid in an unmovable manner and far from parts subject to high temperatures. During the final wiring of the circuit, only use components with a suitable electrical

Do not pass electric cables in the immediate vicinity of the flue gas pipe, unless they are insulated with suitable materials.

KLOVER srl declines all responsibility for injury to persons and animals or damage to objects due to failure to connect the appliance to earth or to comply with IEC specifications.

Control of any coupled boiler

If the pellet appliance is to be coupled with a previously installed boiler in the system (e.g. wall-hung gas boiler), you must ensure that the standard boiler stops when the pellet appliance takes over the heating of the system. The electrical setting, which is accessible from the *rear technical compartment*, intervenes on the standard boiler when the heating circulating pump of the pellet appliance starts up so as to avoid having two boilers operating simultaneously on the same system. The coupled boiler is however always available for the production of domestic hot water.

The two wires prepared on the back of the appliance (blue and brown wires) will have an output voltage of 220 V when the pellet appliance pump is working, and no voltage when the pump stops.

It is therefore necessary to connect the 2 wires to a relay that will control the Room Thermostat (R.T.) input of the coupled boiler (see the following example).

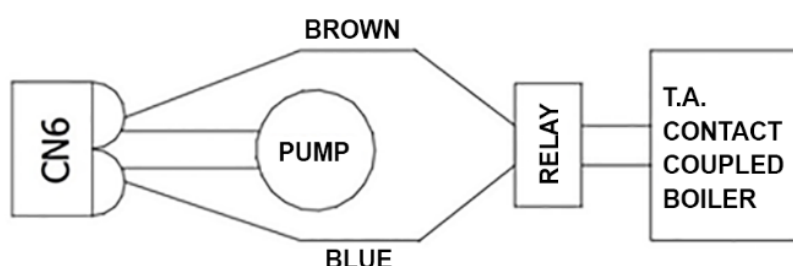

Control of a possible three-way motorised valve for the DHW system (on SM80-P and SM80-BP models only)

The pellet appliance is equipped as standard with a control for a possible 3-way motorised valve to be installed on the domestic water circuit (*for prepared models only*). In the *rear technical compartment* of the appliance there are four wires with fastons protected by a red seal, which can be used for controlling the valve (see also "*wiring diagram*"). The four wires have different colours, and precisely:

- Blue wire = 3-WAY VALVE COMMON
- Black wire = PELLETT APPLIANCE SANITARY SIDE
- Brown wire = GAS BOILER SANITARY SIDE
- Yellow/green wire = GND

Below there is an example of a connection using a 3-way valve with spring return. Remember that the hydraulic connection must be made in such a way that when the valve is at rest, the water passes from the gas boiler. Only when the appliance temperature is sufficient (see "*Menu 5 – 3 Way Threshold*"), the three-way valve is powered, closing the gas boiler water circuit and opening the water circuit of the appliance.

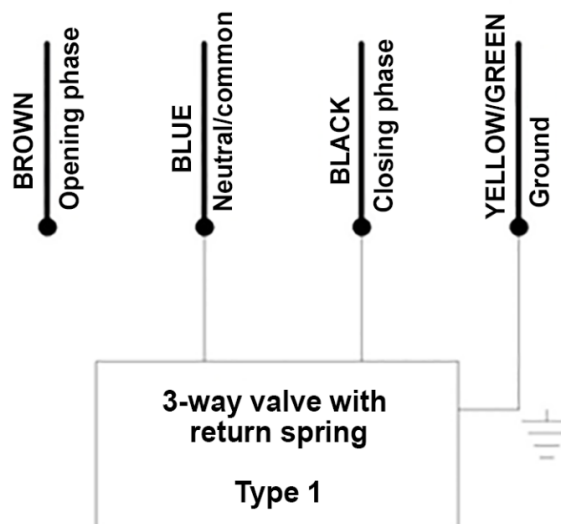

N.B.: in the example above, the brown wire can be used to control a service relay.

Connection to the room thermostat

On the back of the appliance there is a bridged terminal which is used to connect the environment thermostat that will command the operation.

OPERATING PRINCIPLE

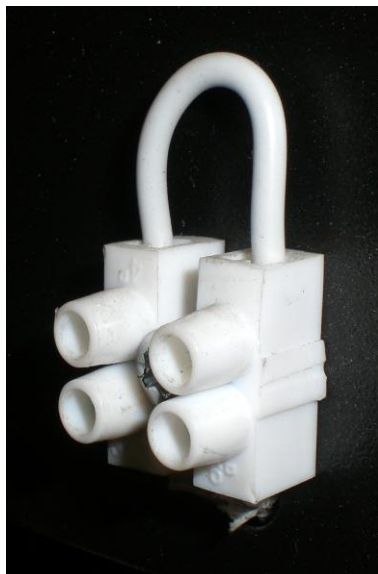

Open contact:

- The appliance switches directly to economy mode operation "T-OFF ECONOMY" thus minimising its operating power.
- The heating circulating pump of the appliance switches off.
- The temperature in the boiler increases due to thermal inertia until it reaches the temperature set with "SET H2O" and displays "T-H2O ECONOMY" on its monitor.
- The appliance now switches itself off automatically if at least one of the following conditions occurs:
 - If it remains in Economy mode Operation "T-H2O ECONOMY" for a time set on Pr44 (30 minutes as default setting).
 - If it exceeds the temperature differential set on Pr43 (set as default at 5°C), in other words if $\text{Temperature H2O} > (\text{"SET H2O"} + \text{Pr43})$.
- The appliance will switch on again automatically if both of the following conditions occur:
 - The contact of the room thermostat closes.
 - The temperature falls below the temperature differential set on Pr43 (set as default at 5°C), in other words $\text{H2O Temperature} < (\text{"SET H2O"} - \text{Pr43})$.

If the above condition occurs during the switch-off cycle, please wait until the cycle is complete.

N.B.: If the water temperature exceeds the threshold set on Pr50 (set as default at 83°C), the circulating pump of the system is forcedly switched-on to ensure the disposal of excessive heat, thus avoiding the reaching of high temperatures of the water in the boiler. For this reason it is recommended that the heating system is not entirely closed (e.g. ensuring a radiator is fitted with open lockshield valves only, or having an openzone under floor heating circuit).

WARNING: If the room sensor in the "Remote Control" is also enabled (see "Menu 04 – Enable Contact") the appliance enters the economy mode when both instances are satisfied.

In case of setting one of the three OVEN OUTPUT POWERS, be aware that room thermostat is excluded.

PLUMBING CONNECTIONS

The plumbing connections must be made in a rational way using the connections on the template of the appliance. To facilitate the connection of the pipes, all the plumbing connections have been fitted on the rear side, leaving space to make the appropriate connections.

The appliance can be coupled with any other boiler already installed on the system. In this case it is essential to fit all the necessary safety devices and shut-off valves based on the system and intended use. It is also necessary to consider all laws and national, regional, provincial and municipal regulations of the country where the appliance is installed.

N.B.: The appliance can be installed on a sealed heating system because it is equipped with a device for stopping fuel loading, a safety manual reset thermostat and an audible alarm, which are activated if the temperature goes too high.

You can install the appliance in the same room as another boiler only if the other boiler is a room sealed appliance; installation must be performed in compliance with the current regulations.

The maximum mains water pressure should never exceed 3 bar; recommended operating pressure: 1.5 bar (during operation).

In the event of water with hardness exceeding 28 °f, an anti-limescale device must be installed. This must be selected on the basis of the specific properties of the water.

IT IS MANDATORY TO INSTALL ONE FILTER AND A MAGNETIC DIRT SEPARATOR FILTER AFTER THE APPLIANCE RETURN PIPE IN ORDER NOT TO COMPROMISE BOTH THE WORKING PROCESS AND THE DURATION WORKING TIME OF THE CIRCULATION PUMP.

The appliance must be mounted exclusively by qualified personnel. Scrupulously comply with the instructions given in this guide.

The manufacturer declines any liability for damages caused due to incorrect assembly.







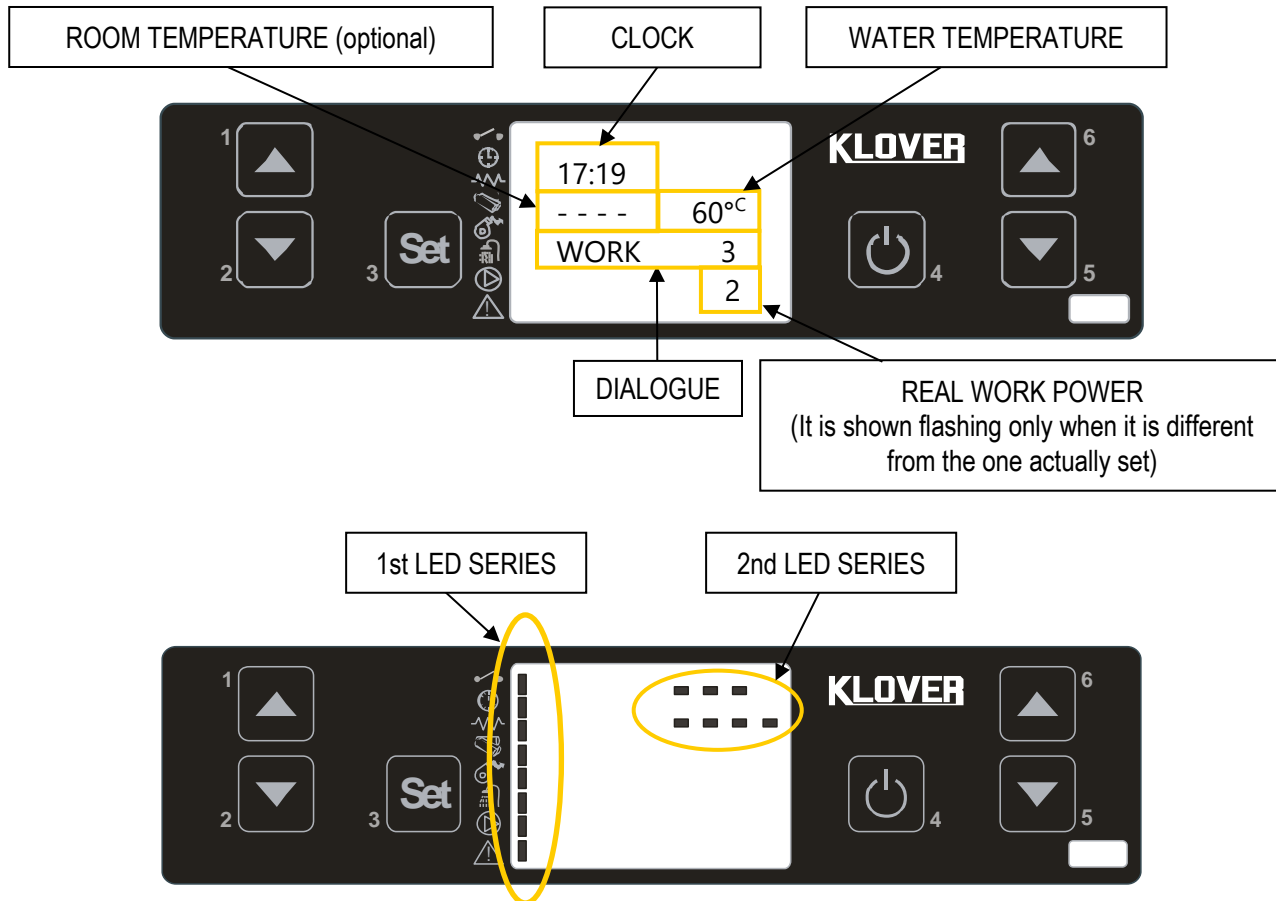

THE DISPLAY

The appliance's operating mode is displayed on the console. After turning on the menu, it is possible to choose from many types of display and available settings according to the selected menu.

The figures below show the display when the appliance is in ON mode.



The following figure describes the meanings of the status signals appearing on the display left side (*1st LED SERIES*).

	ROOM THERMOSTAT: the LED is on when the thermostat contact is open.
	PROGRAMMABLE THERMOSTAT: the LED lights up when at least one start-up and switch-off program is active.
	IGNITION HEATING ELEMENT: the LED is on when the ignition heating element is active.
	SCREW FEED: the LED lights up when the pellet loading gear motor is started.
	FLUE GAS EXTRACTOR: the LED lights up when the flue gas extractor is active.
	DHW FLOW SWITCH: the LED lights up when the DHW flow switch contact is closed (which means there is demand for hot water). <i>LED only works when the flow switch is connected</i>
	PUMP: the LED lights up when the system circulation pump is active.
	ALARM: the LED lights up when the boiler is in a state of alarm.

The meanings of the status signals appearing on the top right side of the display are described below (*2nd LED SERIES*).

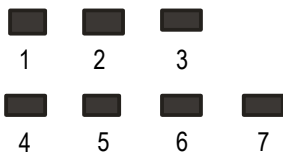

- LED 1: the LED lights up when the daily programme of the on off settings is active.
- LED 2: the LED lights up when the weekly programme of the on off settings is active.
- LED 3: the LED lights up when the weekend programme of the on off settings is active.
- LED 4: the LED lights up (flashing) when the operation parameters are being edited.
- LED 5: the LED lights up when the summer function is active (Not used on this product).
- LED 6: the LED lights up when the winter function is active.
- LED 7: the LED is not currently used.

The following diagram shows the display when setting or programming operating parameters.

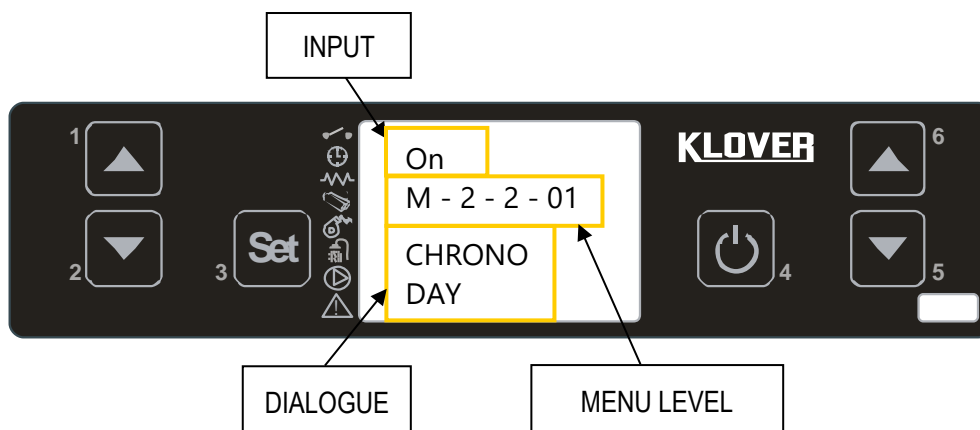

The INPUT area shows the entered programming values.

The MENU LEVEL area shows the current parameter/menu level.

The DIALOGUE area displays the meaning of the current parameter/menu.

The table explains how the buttons on the display work.

KEY	DESCRIPTION	MODE	ACTION
1	Increase temperature (1)	Programming mode..	Changes/increases the value of the selected menu item.
		Working/off..	It increases the temperature of the room/water thermostat.
2	Decrease temperature (2)	Programming mode..	Changes/decreases the value of the selected menu item.
		Working/off..	It decreases the temperature of the room/water thermostat.
3	Set	-	Enters the menu in question.
		Menu mode..	Accesses the next level of sub-menus.
4	ON/OFF Outlet	Working..	Switches the appliance on and/or off when pressed for 2 seconds.
		In alarm block..	Releases the alarm.
		Menu/programming mode..	Moves you to the previous menu level, saving the changes made.
5	Decrease power (3)	Working/off..	Decreases the working power of the appliance.
		Menu mode..	Moves you to the next menu item.
		Programming mode..	Moves you to the next submenu item, storing the changes made.
6	Increase power (3)	Working/off..	Increases the working power of the appliance.
		Menu mode..	Moves you to the previous menu item.
		Programming mode..	Moves you to the previous submenu item, storing the changes made.

(1) It selects the WATER TEMPERATURE SET "SET H2O" when first pressed.

(2) It selects the ROOM TEMPERATURE SET "SET ROOM TEMP" when first pressed.

(3) It selects the WORKING OUTPUT "SET POWER" when first pressed.

THE MENU

Access the Menu by pressing key 3 (Set).

The menu is divided into different items and levels, providing access to the programming and settings options of the appliance.

Buttons 5 and 6 allow you to select the menus to be modified.

Buttons 1 and 2 allow you to change the set value in the selected menu.

Listed below are the menus present on the PCB, with the relevant explanations.

Menu 01 – Set clock

Allows for setting the current date and time.

Menu 02 – Set chrono**Sub-menu 02 – 01 – Enable chrono**

Allows you to globally enable and disable all programmable thermostat functions. For the correct operation it is recommended to enable it ("ON") when at least one on/off programme (daily, weekly or weekend programme) is activated.

MENU LEVEL	SELECTION	MEANING	POSSIBLE VALUES
02 – 01 – 01	ENABLE CHRONO	Enable/disable set programs	ON – OFF

Submenu 02 – 02 – Program day

Allows you to enable, disable and set the programmable thermostat daily programme functions.

Two operating time slots can be set according to the following table, where OFF signals the clock to ignore the command:

MENU LEVEL	SELECTION	MEANING	POSSIBLE VALUES
02 – 02 – 01	CHRONO DAY	Enable/disable the daily programme	ON – OFF
02 – 02 – 02	START 1 DAY	Turn-on time of the first programme	Time – OFF
02 – 02 – 03	STOP 1 DAY	Turn-off time of the first programme	Time – OFF
02 – 02 – 04	START 2 DAY	Turn-on time of the second programme	Time – OFF
02 – 02 – 05	STOP 2 DAY	Turn-off time of the second programme	Time – OFF

Sub-menu 02 – 03 – Program week

Allows you to enable, disable and set the programmable thermostat weekly program functions.

MENU LEVEL	SELECTION	MEANING	POSSIBLE VALUES
02 – 03 – 01	CHRONO WEEKLY	Enable/disable the weekly programme	ON – OFF

The weekly programmer has 4 independent on/off programmes; it is not essential to use all four simultaneously. By setting OFF in the time field, the clock ignores the corresponding command.

PROGRAM 1			
MENU LEVEL	SELECTION	MEANING	POSSIBLE VALUES
02 – 03 – 02	START PROG-1	Turn-on time of the first programme	Time – OFF
02 – 03 – 03	STOP PROG-1	Turn-off time of the first programme	Time – OFF
02 – 03 – 04	MONDAY PROG-1	Reference days of the first programme	On/off
02 – 03 – 05	TUESDAY PROG-1		On/off
02 – 03 – 06	WEDNESDAY PROG-1		On/off
02 – 03 – 07	THURSDAY PROG-1		On/off
02 – 03 – 08	FRIDAY PROG-1		On/off
02 – 03 – 09	SATURDAY PROG-1		On/off
02 – 03 – 10	SUNDAY PROG-1		On/off

PROGRAM 2			
MENU LEVEL	SELECTION	MEANING	POSSIBLE VALUES
02 – 03 – 11	START PROG-2	Turn-on time of the second programme	Time – OFF
02 – 03 – 12	STOP PROG-2	Turn-off time of the second programme	Time – OFF
02 – 03 – 13	MONDAY PROG-2	Reference days of the second programme	On/off
02 – 03 – 14	TUESDAY PROG-2		On/off
02 – 03 – 15	WEDNESDAY PROG-2		On/off
02 – 03 – 16	THURSDAY PROG-2		On/off
02 – 03 – 17	FRIDAY PROG-2		On/off
02 – 03 – 18	SATURDAY PROG-2		On/off
02 – 03 – 19	SUNDAY PROG-2		On/off

PROGRAM 3			
MENU LEVEL	SELECTION	MEANING	POSSIBLE VALUES
02 – 03 – 20	START PROG-3	Turn-on time of the third programme	Time – OFF
02 – 03 – 21	STOP PROG-3	Turn-off time of the third programme	Time – OFF
02 – 03 – 22	MONDAY PROG-3	Reference days of the third programme	On/off
02 – 03 – 23	TUESDAY PROG-3		On/off
02 – 03 – 24	WEDNESDAY PROG-3		On/off
02 – 03 – 25	THURSDAY PROG-3		On/off
02 – 03 – 26	FRIDAY PROG-3		On/off
02 – 03 – 27	SATURDAY PROG-3		On/off
02 – 03 – 28	SUNDAY PROG-3		On/off

PROGRAM 4			
MENU LEVEL	SELECTION	MEANING	POSSIBLE VALUES
02 – 03 – 29	START PROG-4	Turn-on time of the fourth programme	Time – OFF
02 – 03 – 30	STOP PROG-4	Turn-off time of the fourth programme	Time – OFF
02 – 03 – 31	MONDAY PROG-4	Reference days of the fourth programme	On/off
02 – 03 – 32	TUESDAY PROG-4		On/off
02 – 03 – 33	WEDNESDAY PROG-4		On/off
02 – 03 – 34	THURSDAY PROG-4		On/off
02 – 03 – 35	FRIDAY PROG-4		On/off
02 – 03 – 36	SATURDAY PROG-4		On/off
02 – 03 – 37	SUNDAY PROG-4		On/off

Sub-menu 02 – 04 – Program week-end

Enables/disables/sets the programmable timer's weekend functions (Saturday and Sunday).

MENU LEVEL	SELECTION	MEANING	POSSIBLE VALUES
02 – 04 – 01	CHRONO WEEK-END	Enable/disable the weekend programme	ON – OFF
02 – 04 – 02	START 1 WEEK-END	Turn-on time of the first programme	Time – OFF
02 – 04 – 03	STOP 1 WEEK-END	Turn-off time of the first programme	Time – OFF
02 – 04 – 04	START 2 WEEK-END	Turn-on time of the second programme	Time – OFF
02 – 04 – 05	STOP 2 WEEK-END	Turn-off time of the second programme	Time – OFF

TIP: in order to avoid confusion and any undesired switching on/off operations, only activate a single programme at a time (daily, weekly or weekend programme).

Deactivate the daily program if you wish to use the weekly program instead. If you use the weekly program in programs 1, 2, 3 and 4, always keep the week-end program disabled.

Only enable week-end programming after disabling the weekly program.

Menu 03 – Select language

Allows you to select the dialogue language from the available choices (Italian, English, French, German and Spanish).

Menu 04 – Enable contact (only available if the remote control room thermostat sensor is enabled)

Enables operation of the Room Thermostat contact if the room temperature sensor on the "Remote control" is enabled (see the "Remote Control" manual).

The Room Thermostat contact operation is always active if the room sensor on the external "Remote control" is disabled.

For example:

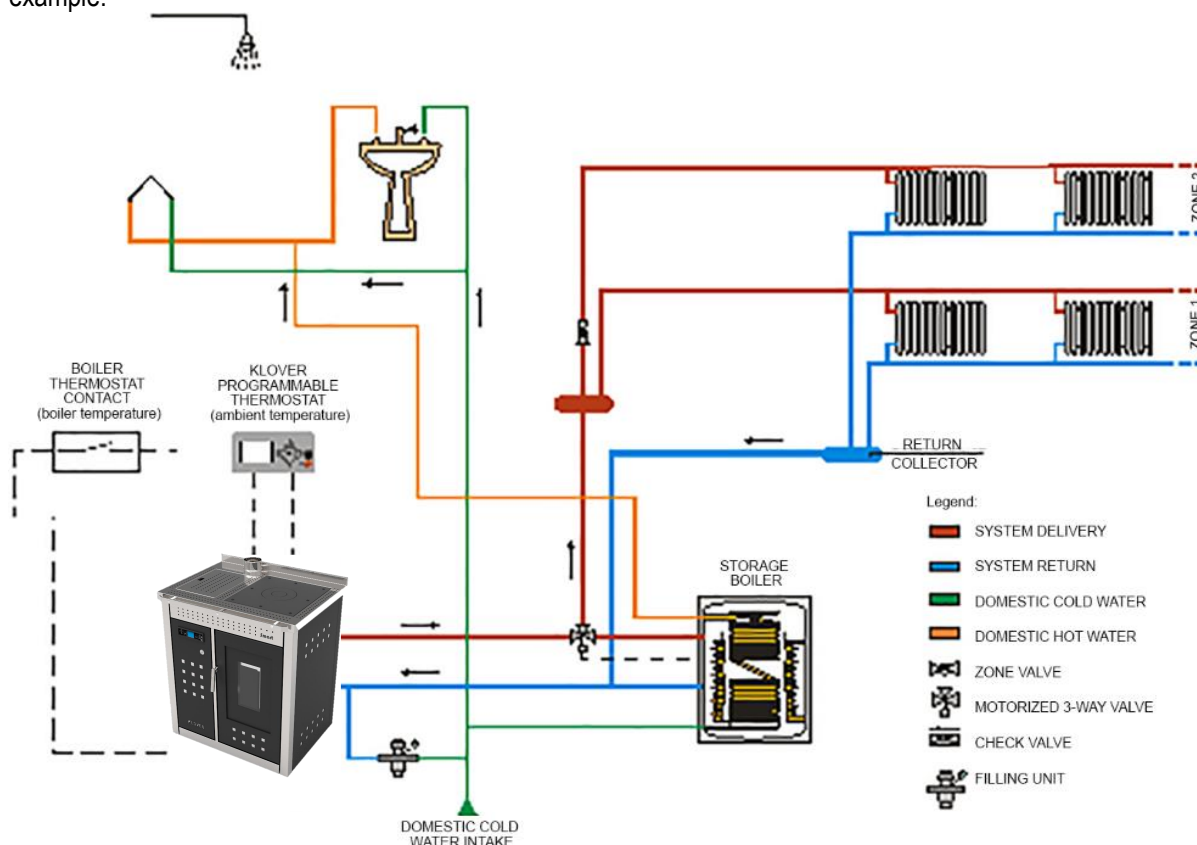

In this condition...

...to control the appliance with only the KLOVER "Remote control" room temperature sensor:

- enable the room sensor on the "Remote control" (Stove settings menu +> Enable room sensor -> ON)
- disable the boiler thermostat contact on the display of the appliance (Menu 4 - Enable contact -> OFF)

In this case, the appliance first enters economy mode operation, and then automatically switches off when the desired room temperature (detected with KLOVER "Remote control") is reached.

...to control the appliance with both the KLOVER "Remote control" room temperature and the boiler thermostat:

- enable the room sensor on the "Remote control" (Stove settings menu +> Enable room sensor -> ON)
- enable the boiler thermostat contact on the display of the appliance (Menu 4 - Enable contact -> ON)

In this case, the appliance first enters economy mode operation, and then automatically switches off when both temperatures have been reached.

...to control the appliance with the boiler temperature only:

- disable the room sensor on the "Remote control" (Stove settings menu +> Enable room sensor -> OFF). The room sensor is automatically disabled if no external "Remote control" is connected.
- enable or disable the boiler thermostat contact on the display of the appliance (Menu 4 - Enable contact -> ON/OFF).

In this case, the appliance first enters economy mode operation, and then automatically switches off when the boiler temperature (measured with an external thermostat immersed in the boiler) has been reached. This may be a viable solution to heat DHW in summer.

...to control the appliance without using external thermostats, but only with the water temperature in the heating system:

- disable the room sensor on the "Remote control" (Stove settings menu +> Enable room sensor -> OFF). The room sensor is automatically disabled if no external "Remote control" is connected.
- enable or disable the boiler thermostat contact on the display of the appliance (Menu 4 - Enable contact -> ON/OFF). The contact must obviously be bridged (already provided as standard).

Only when reaching the temperature set in "SET H2O" the appliance enters economy mode operation.

Summary:

CASE	REMOTE CONTROL ROOM SENSOR	MENU 04 – ENABLE R.T. CONTACT	ACTION
1	OFF	OFF	It works with room thermostat contact.
2	OFF	ON	It works with room thermostat contact.
3	ON	OFF	It works with remote control room sensor only.
4	ON	ON	It works with remote control room sensor and room thermostat contact.

Menu 05 – 3-Way Threshold (can be used only on models with DHW)

It allows setting the temperature threshold for switching the 3-way motorised valve installed in the DHW system. Change-over occurs after 30" from reaching the set temperature and with a hysteresis of 2°C.

For example:

3-way Valve Threshold = 55°C

The valve opens after 30" from reaching 55°C.

The valve closes if 52°C is reached.

Menu 06 – Acoustic alarm

Allows you to enable or disable the acoustic signal in the event of an alarm. The alarm signal is only available on the appliance board, and not on the external "Remote control".

Menu 07 – Initial load

Enables pellet pre-loading for 90" when the appliance is switched off and cooled down. Start the function with button 1 and stop with button 4. This may be useful if the appliance is switched on after the tank has been completely emptied, or when it is filled for the first time. **Warning: once the operation has been completed, before switching on the appliance you should empty the accumulation of pellets deposited inside the brazier.**

Menu 08 – Stove state

It allows for viewing the instantaneous state of the appliance, by showing the state of the various devices connected to it. Several pages are displayed in succession. The data is reserved for Technical assistance Centre.

Menu 09 – Technic calibrat

Allows you to access all data reserved for the Technical Assistance Centre. Access is protected by a password. Unauthorised access can cause serious damage to the equipment, to things and the environment as well as personal injuries.

INITIAL START-UP**Filling the system for the first time**

After the water connection of the appliance, fill the system as follows:

- Check the seal of all piping, the expansion vessel, and the circulation pump;
- Open the "manual air release valve" on the appliance;
- Open the "system load cock" to load the system. Gradually allow the air to come out from the appliance through the "manual air release valve"; **optimum working pressure is 1.5 bar (when the appliance is operating)**;
- Vent all radiators and any other de-aeration systems to ensure that there are no air bubbles in the system.

After installation, check the seal of all plumbing joints for the first few days of operation.

The system and the water inside the boiler can be emptied by opening the "boiler body and system drain cock" situated at the right side of the appliance.

In intensely cold periods it is good practice to leave the heating system running. In the event of a prolonged absence, anti-freeze must be added to the heating water or the system must be completely emptied.

In a system subject to being emptied frequently, it is essential that filling is performed with water suitably treated to remove hardness which can give rise to scaling.

NEVER OPERATE THE APPLIANCE WITHOUT WATER IN THE BOILER BODY. SHOULD IT HAPPEN, THE APPLIANCE WOULD NOT HEAT THE ROOM AND IT COULD SERIOUSLY COMPROMISE THE OPERATION AND THE DURATION OF THE SAME.

Pellet loading and connection to the mains power supply

Perform the following operations:

- Connect the appliance to the electrical system by using the provided cable;
- Set the "main switch ON/OFF" to "I" (ON);
- Fill the pellet tank; for the first ever ignition, to avoid wasting the time required for filling the entire screw feed channel (**this should be done every time the appliance runs out of pellets**), we recommend you follow the instructions in the "MENU 07 – INITIAL LOAD";
- Switch the appliance on by using the ignition button on the display (button 4). See the instructions below. **Warning: before switching on the device make sure that there are no pellets in the brazier; otherwise it is necessary to empty and clean the brazier.**

WARNING: DO NOT LOAD MANUALLY PELLETS IN THE GRATE IN ORDER NOT TO COMPROMISE THE SAFETY AND WORKING OPERATION OF THE APPLIANCE.

We recommend that you use high quality pellets so as not to impair the operation of the appliance. Damage caused by poor-quality pellets shall not be covered by the warranty.

Ignition cycle

Pressing button 4 (ON/OFF) for a few seconds allows you to start the ignition cycle. After a while, the display shows "START", and the flue gas intake device and ignition resistance switch on. After a few seconds the appliance goes into a phase of preheating "AFTERPRE PRE-HEAT" useful to sufficiently heat the ignition resistance before the loading of the pellets in the brazier. After the pre-loading phase the appliance switches to the "HOLD FLAME" phase where the pellets are loaded into the brazier at regular intervals. When the flame is lit, the display shows the message "FIRE". This step is used to allow the fire to spread evenly across the brazier and burn all the unburned pellets from the previous phases. After these phases, the appliance enters the work mode at the pre-set power value.

If the ignition fails, the display will show the alarm "NO IGNITION".

The alarm may also occur if the brazier is dirty; in this case, clean the brazier and re-start.

Summary:

The ignition cycle can last 25/30 minutes max. and is divided into five steps:

- | | |
|----------------------------|---|
| Step 1 - START | = Ignition of the flue gas extractor. |
| Step 2 - AFTERPRE PRE-HEAT | = Waiting for the resistance preheating. |
| Step 3 - PELLETT P-LOAD | = Pellet pre-load (initial continuous load) and resistance ignition. (Not as standard settings) |
| Step 4 - HOLD FLAME | = Loading pellets (intermittent load) and resistance operating. |
| Step 5 - FIRE | = Resistance switch-off and flame stabilisation. |

The appliance switches into working mode after ignition phase at the power output set during ignition via buttons 1 and 2.

Warning: during the ignition phase and normal operation of the appliance, maintain the necessary safety distance and do not stand in front of it.

Working mode from power 1 to power 5

During the working phase, by pressing 1, you can set the "SET H2O" (maximum water temperature in the boiler). When this temperature is reached, the appliance enters economy mode operation "T-H2O ECONOMY".

5°C before reaching the temperature set on "SET H2O", the appliance starts modulating output by decreasing the pellet intake and reducing the flue gas extraction speed.

For example: "SET H2O" set at 75 °C
Working power set at 5

- Working power automatically changes to 4 when the temperature reaches 71°C.
- Working power automatically changes to 3 when the temperature reaches 72°C.
- Working power automatically changes to 2 when the temperature reaches 73°C.
- Working power automatically changes to 1 when the temperature reaches 74°C.
- Working power automatically changes to economy mode operation "T-H2O ECONOMY" when the temperature reaches 75°C.

The appliance will now automatically switch itself off if at least one of the following conditions occurs:

- If it remains in Economy mode Operation "T-H2O ECONOMY" for a time set on Pr44 (30 minutes as default setting).
- If it exceeds the temperature differential set on Pr43 (set as default at 5°C), in other words if Temperature H2O > ("SET H2O" + Pr43).

The appliance automatically starts up again if the following condition occurs:

- The temperature falls below the temperature differential set on Pr43 (5°C as default setting) or H2O Temperature < ("SET H2O" – Pr43).

If the above condition occurs when the switch-off cycle is not yet completed, please wait until the cycle is complete.

The cleaning cycle of the brazier (displayed under "BRAZIER CLEANING") is done at predetermined time intervals for an established period (see "PCB parameters").

Working mode at Sanitary Power (in pre-set models only)

Herewith under description of the operating mode working with sanitary power.

The domestic hot water is produced instantaneously in a double heat exchanger fully submerged in water and built-in inside the unit. To get a sufficient amount of sanitary hot water it is necessary that the appliance reaches the proper temperature (at least 65° C).

Should it required a fairly good amount of hot water, switch manually the appliance to "SANI" power (see "Changing the working power operation"). The purpose of the "SANI" power is to postpone the starting of the circulation heating pump at higher temperatures in such a way to release all the heat developed to the sanitary water. Thus during this phase the circulating heat pump mounted in the heating system is off. When it is not required sanitary hot water, reset the appliance to one of the five work powers ("1", "2", "3", "4" and "5").

The appliance is also pre-set for electrical connection with a flow switch mounted in the sanitary system; the flow switch allows to automatically switch to "SANI" power operation in case of demand for domestic hot water. For electrical connection of the flow-switch please contact an *Authorized Technical Assistance Centre*.

In case of particularly hard water, it is necessary to install a softener in the water inlet of the heat exchanger, to be chosen according to the water characteristics.

Should a decrease in the amount of water or hot water temperature be noticed, it might be necessary to clean the heat exchanger; for cleaning, please contact an authorized installer for the heat exchanger chemical cleaning.

Working mode in Cooking plate / Oven output

Besides setting one of the five available WORKING OUTPUT VALUE (from 1 to 5) and the DHW OUTPUT, pressing button 6 also allows selecting one of the three OVEN OUTPUT VALUE (OVEN 1, OVEN 2, OVEN 3) which can only be

set when you want to cook. Therefore, press keys 5 and 6 to set the desired output. During this operation, the display appears as in the figure below.

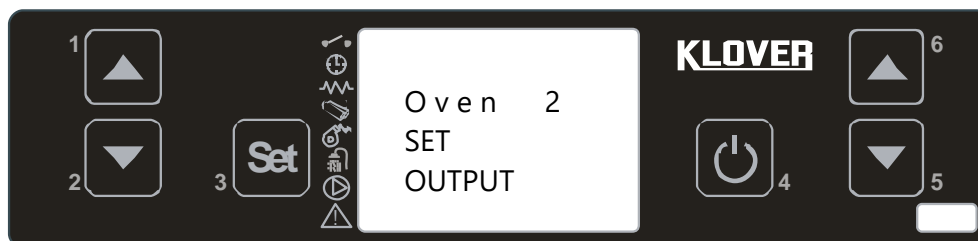

By setting one of the three available OVEN OUTPUT VALUE, the operation of the room thermostat (or of any other combined thermostat) is excluded. So the central heating cooker will enter modulation mode and then go off only if the temperature set on SET OVEN is reached.

Re-set one of the five WORKING OUTPUT VALUE (from 1 to 5) when you have finished cooking.

To cook on a cast iron radiant plate, you should place the pot on the hottest point of the plate or in the middle of the circles drawn on it. Only use flat bottom pots evenly adhering over the base.



By setting one of the three available OVEN OUTPUT VALUE, the operation of the room thermostat (or of any other combined thermostat) is excluded. So the central heating cooker will enter modulation mode and then go off if the temperature set on SET OVEN is reached (75°C default setting - see parameter tables) or the water reaches the target temperature (usually 75°C). Even though the thermostat response to the stove is excluded both the thermostatic radiator valves and the zone valve will automatically close when the heating reaches the set temperature, so stopping the flow to the heating circuit. This will cause the stove to modulate down and then turn itself off. It is usual to install a thermal store with a pellet stove, as it improves efficiency, and this allows the user to set the store demand to coincide with the cooking period. It is also common to set the domestic hot water demand to coincide with the cooking period.

Switch-off cycle

Pressing button 4 (ON/OFF) the appliance switches itself off. The display will show **"FINAL CLEANING"**. Pellet loading is stopped, turning off the gear motor. The flue gas extractor speed increases to maximum and then switches off after the cooling of the appliance, displaying **"OFF"**.

Changing the working power

To change the working power simply select the "SET POWER" by pressing keys 6. Then press keys 5 and 6. During this operation, the display appears as it is shown in the figure herewith below

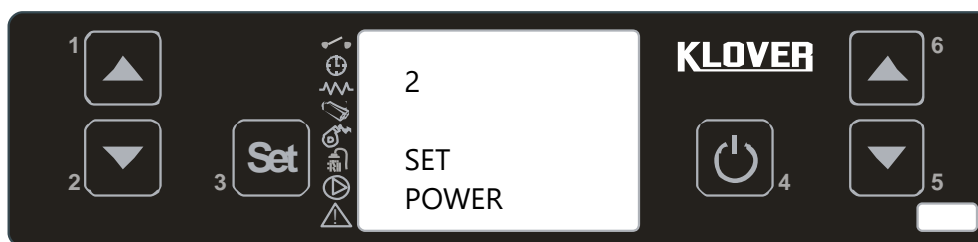

It is also possible to select one of five working powers ("1", "2", "3", "4" and "5") (see ["working mode from power 1 to power 5"](#)), select the domestic sanitary power ("SANI") (see ["Working mode at sanitary power"](#)), or even one of the three output powers of the oven ("Oven 1", "Oven 2" and "Oven 3") (see ["Working mode in cooking plate / oven output"](#)). After setting the desired value, confirm by pressing the button 4, or wait just a few seconds.

Changing the room and water temperature

- Heating system Water Temperature

To modify the water temperature, simply select "SET H2O" by pressing button 1. Now use buttons 1 and 2. During this operation, the display will appear as in the following picture.

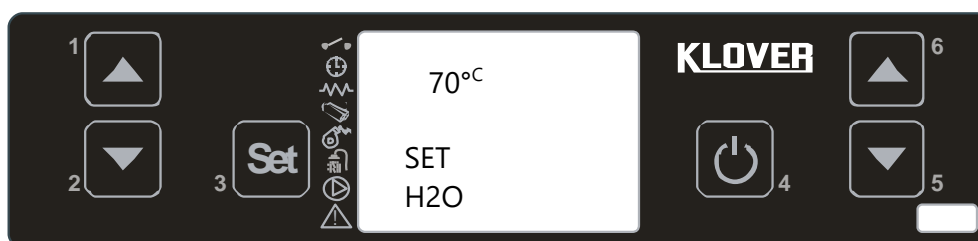

After setting the desired value, press button 4 or wait a few seconds to confirm.

During the working mode the appliance enters "Economy mode operation" when that temperature value is reached (See ["Working mode"](#)).

- Room Temperature (used only in case of the "Remote control" connection)

To modify the ambient temperature, simply select "SET ROOM TEMP" by pressing button 2. Now use buttons 1 and 2. During this operation, the display will appear as in the following picture.

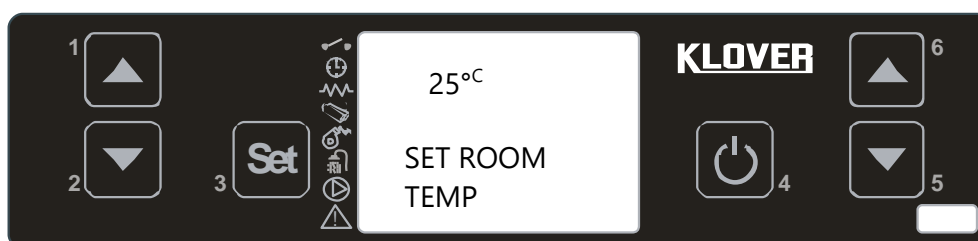

After setting the desired value, press button 4 or wait a few seconds.

In the case of reaching the set temperature, the appliance will perform the same procedure as with the opening of the room thermostat (See ["Connection to the room thermostat"](#)).

PROBLEMS, ALARMS, USEFUL ADVICES

Useful info...

Listed below is some important information regarding the appliance:

- It is normal for the appliance to emit a smell of paint during its first few days of operation. We recommend ventilating the installation room during the initial start-up. For the first few days of operation we also recommend that you set the appliance to near-maximum level.
- The boiler body is treated with anti-oxidant paint in order to protect it against oxidation in the event of long periods of inactivity. After initial start-up, this paint no longer preserves its original features and any wear of the paint inside the combustion chamber should not be regarded as a manufacturing fault.
- Do not clean with water inside the combustion chamber; any oxidation of the combustion chamber after a long period of inactivity is not to be considered as a manufacturing fault.
- Any perceived noise during operation may be caused by the expansion settling of the plates that make up the boiler body. These noises are accentuated especially during ignition and switching off phases of the appliance and are not to be considered a manufacturing fault.
- **If ignition fails, empty the pellets out of the brazier; only then can you reignite the appliance in order to avoid gasification and consequent "explosion" during ignition which could lead to the breakage of the door glass.**
- The door of the appliance does not provide airtight closing (opening for secondary-post combustion air passage); any perceived smoke smell (especially during ignition) is not to be considered a manufacturing fault.
- The appliance works exclusively with wooden pellets; do not burn different fuels.
- The appliance can work only if connected to the heating system and with water inside the boiler body. Do not start-up the appliance for any reason if a plumbing connection in compliance with current regulations has not been done and if you have not filled the entire boiler body and system with water in order not to compromise its duration.
- The noise level of the appliance is emphasised if the pellet container is empty. Therefore we recommend that you always keep the pellet level to at least half tank.
- If you find soot and fine particles in the room where the appliance is installed, check the sealing of flue pipes and the filter of the ash vacuum device used for cleaning.

What happens if...

...the pellets do not ignite

If the ignition fails, the display will show the alarm message "NO IGNIT ALLARM".

Cancel the alarm and reset the appliance to standard condition by pressing button 4 for a few seconds.

If ignition fails, empty the pellets out of the brazier; only then can you reignite the appliance in order to avoid gasification and consequent "explosion" during ignition which could lead to the breakage of the door glass.

...the fire door is open or not properly closed

If the door is left open or not properly closed, the pellet loading will not start, therefore the appliance will not switch itself on. If the door is opened during normal operation, the appliance switches to "THERMAL SAFETY" alarm.

...the flue pipe is dirty, blocked or not correctly installed

If the flue is dirty, blocked or incorrectly manufactured, pellet loading will not start, thus the appliance will not switch itself on. If the flue is obstructed during normal operation, the appliance switches to "DEPRESS.-FAILURE" alarm.

...the appliance is overheated

If the water in the boiler body is overheated (>94°C), the pellet will not be loaded because the manual reset thermostat cuts in. If this happens during normal operation, the appliance switches to "THERMAL SAFETY" alarm. It is therefore necessary to reset the "manual reset thermostat" (see "Components of the appliance") before switching the appliance on again. To reset, it is necessary to remove the black cap and press the button below.

...lack of power (blackout)

If a power blackout occurs for a shorter time than Pr48, when power is restored, the appliance will immediately re-start in the working mode (recovering the set working power).

If the outage lasts longer than Pr48, when power is restored, the appliance will enter the "STOP FIRE" (*stand-by*) mode running the entire switch-off cycle until cooling. When this phase is over, the appliance can be restarted resuming work at the set power.

Previous state	Black-out duration	State after power restore
OFF	any	OFF
START	duration < Pr48	START
START	duration > Pr48	START
P-LOAD PELLETT	any	BLACK OUT ALARM
HOLD FLAME	any	BLACK OUT ALARM
FIRE ON	duration < Pr48	FIRE ON
FIRE ON	duration > Pr48	STOP FIRE with automatic re-ignition after machine cooling
WORK (any phase)	duration < Pr48	WORK (any phase)
WORK (any phase)	duration > Pr48	STOP FIRE with automatic re-ignition after machine cooling
BRAZIER CLEANING	duration < Pr48	BRAZIER CLEANING
BRAZIER CLEANING	duration > Pr48	STOP FIRE with automatic re-ignition after machine cooling
FINAL CLEANING	duration < Pr48	FINAL CLEANING and after cooling → OFF
FINAL CLEANING	duration > Pr48	FINAL CLEANING and after cooling → OFF
STOP FIRE	any	STOP FIRE

Alarm signals

The following table describes the different alarms which may appear.

DISPLAY VISUALISATION	ORIGIN OF ALARM
AL 1 - BLACK OUT	Black-out alarm. When power is cut off under determined conditions (<i>see "What happens if..."</i>)
AL 2 - FLUE GAS PROBE	Faulty or disconnected flue gas temperature sensor.
AL 3 - HOT TEMP	Flue gas over-temperature. When flue gas temperature is higher than 260°C. Before displaying the alarm, or when flue gas maximum temperature is reached (Pr14), the display shows "HOT FLUE GAS".
AL 4 - FAULTY INTAKE	Faulty flue gas extractor. When the encoder (tachometer) in the extractor detects an extractor speed equal to 0.
AL 5 - NO IGNIT ALARM	No ignition. When the flue gas minimum temperature (Pr13) is not reached within the maximum ignition cycle time (Pr01).
AL 6 - NO PELL. ALARM	Sudden shut-down during the work phase. When, during the work phase, the flue gas temperature drops below the minimum threshold (Pr28).
AL 7 - THERMAL SAFETY	Temperature safety device. When the safety thermostat (water over temperature) or fire door micro switch (contact interrupted) cuts in. If the safety thermostat cuts in the boiler stove must be manually rearmed.
AL 8 - DEPRESS.-FAILURE	Poor depression. When the flue gas pressure switch cuts in (contact interrupted) due to poor draught in the flue pipe.
AL 9 - WATER PROBE	Faulty or disconnected water temperature probe.
AL c - TRIAC COC	Screw feed TRIAC error. When the screw feed gear motor does not stop for at least 0.2 seconds during the maximum work interval of 8.0 seconds. Before the alarm is activated a safety relay cuts in and forcibly cuts off the power supply to the gear motor.

Every alarm causes the appliance to switch-off immediately. The alarm state is reached after the time set on Pr11 (*set as default at 30"*) and it can be reset by pressing button 4 for a while.

CLEANING AND MAINTENANCE

Precautions before cleaning

Before carrying out any cleaning or maintenance operations, make sure that:

- the appliance is off and has cooled down completely;
- the ash is completely cold.
- the ash vacuum device used for cleaning is suitable and its filter is in good condition.

Before re-starting the appliance, re-install all previously removed components.

During cleaning operations, use the personal protection devices specified in Directive 89/391/EEC.

The required cleaning frequency depends on the type and quality of the pellets used. The schedule indicated below may therefore vary.

Any problem affecting the appliance caused by lack of cleaning will not be covered by the warranty. The failure of these operations could affect the safety of the product.

Routine cleaning

The ordinary cleaning of the appliance must be done at least every 20 hours of operation or after 3-4 ignition cycles, so as to always guarantee efficient performance and optimal operation. Please proceed as follows:



Empty the ash drawer (Figure 1).

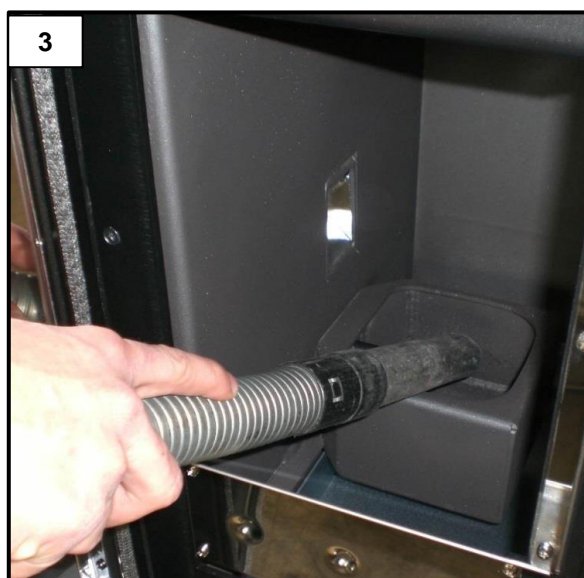

Thoroughly clean the brazier from combustion residues by taking it out from its position and removing any residues inside (Figure 2).

Use a suitable ash vacuum device to remove any ash deposited under the brazier (Figure 3).

WARNING: use suitable ash vacuum devices equipped with a fine mesh filter in order to prevent ash from being blown into the room and to prevent damaging the vacuum cleaner. We do not recommend the use of normal vacuum cleaners.

Non-routine cleaning

The extraordinary cleaning of the appliance must be done at least every 15 days so as to always guarantee efficient performance and optimal operation. Please proceed as follows:

Perform routine cleaning;



Dismantle the outlet side of the combustion chamber (Figure 4) and clean the internal flue gas turn (Figure 5) with the brush provided with the equipment. Suck the ash deposit in the part below. Properly re-position the outlet after cleaning, ensuring the outlet is flue gas sealed.



After removing the ash drawer, extract the underlying base (Figure 6) and, using a suitable suction device, suck the deposit inside (Figure 7). Then re-position the base and ash drawer.

To remove any deposits, it is also recommended that you scrape the inner walls of the combustion chamber with a spatula. Do not use tools that can reduce the thickness of the metal sheet of the boiler body.

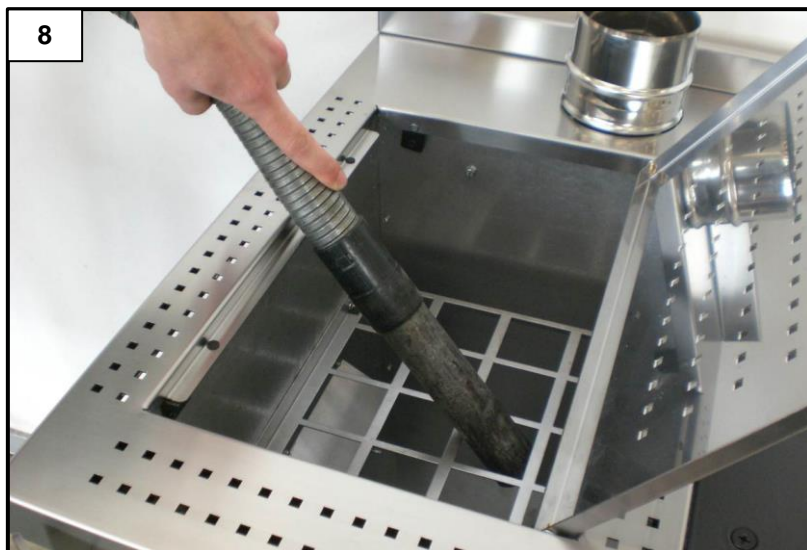

To ensure correct operation, it is necessary to remove the sawdust deposited on the base of the tank (Figure 8) at least once every 15 days. **The pellet tank must be emptied at the end of every season.**

Yearly cleaning

The yearly cleaning of the appliance must be done at least once a year so as to always guarantee efficient performance and optimal operation. Please proceed as follows:

Perform routine and no-routine cleaning;

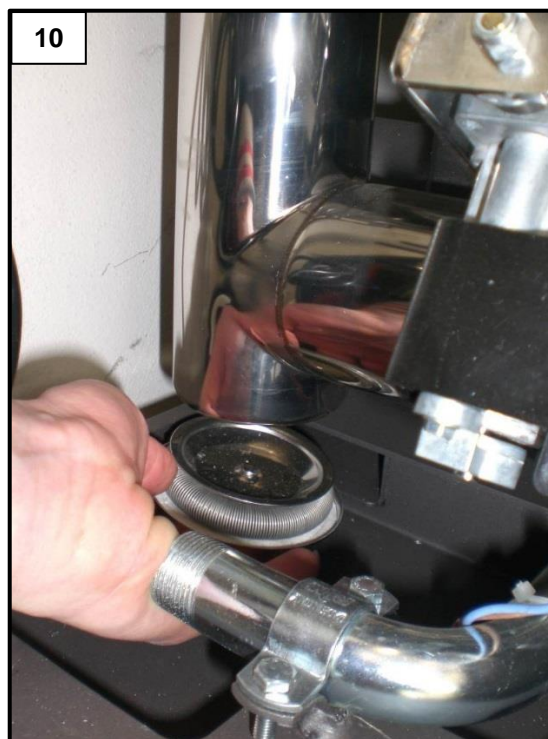

Remove the left side (Figure 9).

Remove cap from rear TEE (Figure 10) and clean the entire flue pipe with a brush, sucking any soot deposit. Properly re-position the cap after cleaning, ensuring it is flue gas sealed. The rear TEE is only available in models with upper flue connection.



Remove the cooking plate by loosening the eight screws all around (Figure 11 and 12).

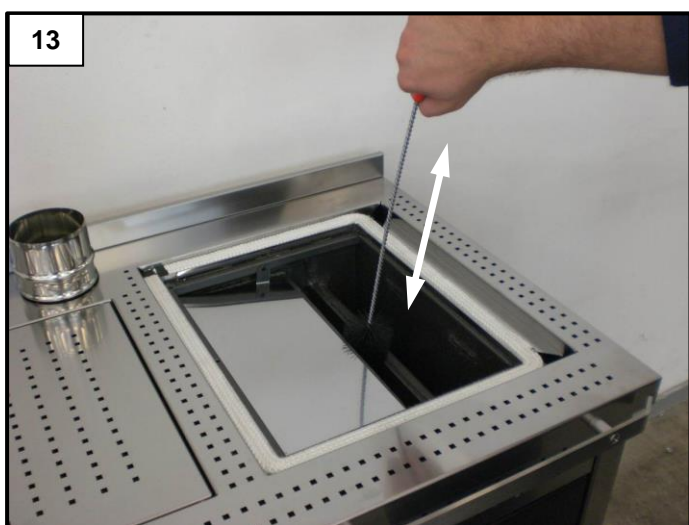

Scrape around the sides using the supplied brush (Figure 13), and vacuum any soot deposit (Figure 14). Re-position the cooking plate after cleaning, ensuring the latter is flue gas sealed.

Cleaning the ceramic glass

Always clean the glass when the appliance is off and has cooled down completely. Use a damp cloth or a detergent specifically formulated for ceramic glass. Do not use abrasive sponges. Do not clean the glass if still warm; changes in temperature can lead to breakage.

Cleaning the cooking plate

The cooking plate is made of enameled cast iron. For cleaning procedure when it is cold, it is sufficient to use a non-abrasive sponge and a suitable liquid dishwashing. Before turning on the appliance once again, make sure that the cleaning agent used has been removed completely and dry the plate with a soft cloth. Never use steel wool or abrasive materials that may scratch the surface. Also avoid the use of aggressive detergents or acids.

Cleaning the flue pipe

The flue pipe cleaning must be performed at least once a year, at the beginning of winter, and whenever necessary. This should only be carried out by a competent chimney sweep with the correct equipment for the type of flue and chimney in place. Suitable sweeps are members of APICS (Association of professional independent chimney sweeps), GMCS (Guild of master chimney sweeps) or NACS (National association of chimney sweeps).

It is important to check for any obstructions in the flue before switching the appliance on following long periods of inactivity.

If cleaning of the flue pipe is not performed, the operation of the appliance and its components may be jeopardised.

The cleaning frequency of the appliance and flue depends on the quality of the pellets used.

USE TOP QUALITY PELLETS TO OBTAIN THE BEST RESULTS.

Maintenance

Timely and systematic maintenance is essential for guaranteeing correct operation, optimal heat performance and durability of the device. Therefore, qualified staff should check the appliance at least once a year at the beginning of the season.

You must periodically check the seals because the latter guarantee the air- and water-tightness of the appliance and its good functioning; if they are worn or damaged you need to be replace them immediately by contacting a **Klover Authorised technical assistance centre**.

For proper operation, the appliance must undergo routine maintenance performed by a Klover Authorised technical assistance centre at least once a year.

Klover pellet appliance is are imported and distributed by Firepower Heating, Flightway, Dunkeswell, Honiton, Devon, EX14 4RD.

UK technical and product support is provided by Firepower Heating who can be reached on 0844 3320156.

PCB PARAMETERS

The parameters stored on the PCB are essential for the correct operation.

The following parameters are already stored during the testing of the appliance directly in the factory; these parameters are the result of special tests using several types of pellets and must not be changed without the authorisation of Klover srl so as not to impair the operation of the appliance.

The company shall not be held liable for any damage caused by the incorrect entry of parameters.

PARAMETERS "VARIOUS SETTINGS" - FIRMWARE (E01_240616)

Parameter	Menu level	Description	Display	Measurement	Value field	Value (P0)
Pr38	M-9-4-01	Re-ignition block	RE IGNIT BLOCK	Minutes	0-10	6
Pr39	M-9-4-02	Flue gas extractor switch-off time	MIN INT BLOCK	Minutes	0-20	10
Pr40	M-9-4-03	Pre-loading time in ignition	IGNIT PRE-LOAD	Seconds	0-225	0
Pr41	M-9-4-04	Stand-by time after pre-loading	AFTERPRE STAND BY	Seconds	0-255	0
Pr42	M-9-4-05	Extractor speed in pre-loading phase	DESP.PR. PRELOAD	RPM	350-2800	2800
Pr43	M-9-4-06	ON/OFF Temperature hysteresis on "SET H2O" and "SET TEMP SANITARI"	DELTA ON OFF AUTO	°C	0-20	5
Pr44	M-9-4-07	Delay at economy operation mode switch-off (timer after reaching "SET H2O")	DELAY OFF AUTO	Minutes	2-120	30
Pr45	M-9-4-08	Power change delay	POWER CHANGE	Seconds	0-60	20
Pr46	M-9-4-09	ON/OFF Temperature hysteresis on "SET ROOM TEMP"	DELTA ON AUTO	°C	0-15	2
Pr47	M-9-4-10	Keypad lock enable	KEY BLOCK EN	On-off	On-off	Off
Pr48	M-9-4-11	Automatic re-ignition after blackout	BLACKOUT IGNITION	Seconds	0-60	30
Pr49	M-9-4-12	Pellet level sensor enable	PELLET RESERVE	On-off	On-off	On
Pr50	M-9-4-13	Pump start for over-temperature safety	PUMP SAFETY	°C	60-90	83
Pr51	M-9-4-14	DHW temperature setpoint	SET TEMP SANITARI	°C	55-80	75
Pr52	M-9-4-15	Preheating time	PRE-HEAT TIME	Seconds	0-480	360
Pr53	M-9-4-16	Extractor speed in preheating phase	PRE-HEAT GASSPEED	RPM	500-2800	2800
Pr54	M-9-4-17	"SET OVEN" Temperature	SET OVEN	°C	70-80	75
Pr55	M-9-4-18	Time after which the alarm occurs "NO PELL. ALARM" if "PELLET RESERVE"	ALARM RESERVE	Minutes	1-180	35

PARAMETERS "DEFAULT SETTINGS" - FIRMWARE (E01_240616)

Parameter	Menu level	Description	Display	Measurement	Value field	Value (P0)
Pr01	M-9-6-01	Ignition cycle maximum time	IGNIT MINUTES	Minutes	5-25	22
Pr02	M-9-6-02	Start time	START MINUTES	Minutes	2-12	4
Pr03	M-9-6-03	Time interval between the two brazier cleaning operations	BRAZIER CLEANING	Minutes	3-240	50
Pr04	M-9-6-04	Screw feed gear motor ON time in ignition phase	IGNIT SCREWS	Seconds	0.1-8.0	2,0
Pr05	M-9-6-05	Screw feed gear motor ON time in start phase	START SCREW	Seconds	0.1-8.0	1,8
Pr06	M-9-6-06	Screw feed gear motor ON time in power 1 work phase	POWER 1 SCREW	Seconds	0.1-8.0	1,8
Pr07	M-9-6-07	Screw feed gear motor ON time in power 2 work phase	POWER 2 SCREW	Seconds	0.1-8.0	2,8
Pr08	M-9-6-08	Screw feed gear motor ON time in power 3 work phase - Oven output 1	POWER 3 SCREW	Seconds	0.1-8.0	4,2
Pr09	M-9-6-09	Screw feed gear motor ON time in power 4 work phase - Oven output 2	POWER 4 SCREW	Seconds	0.1-8.0	5,4
Pr10	M-9-6-10	Screw feed gear motor ON time in power 5 work phase - Oven output 3	POWER 5 SCREW	Seconds	0.1-8.0	6,8
Pr11	M-9-6-11	Alarm delay	ALARMS DELAY	Seconds	1-90	15

Pr12	M – 9 – 6 – 12	Brazier cleaning duration	BRAZIER CLEANING	Seconds	0 – 120	60
Pr13	M – 9 – 6 – 13	Flue gas minimum temperature for considering the stove on	THRESHOL MINIMUM	°C	40 – 180	45
Pr14	M – 9 – 6 – 14	Flue gas maximum temperature	THRESHOL MAXIMUM	°C	110 – 250	250
Pr15	M – 9 – 6 – 15	Flue gas temperature threshold for starting the air exchangers (NOT USED)	BLOWER THRESHOL	°C	50 – 210	210
Pr16	M – 9 – 6 – 16	Flue gas extraction speed in ignition phase	IGNIT FL GASSPEED	RPM	500 – 2800	2300
Pr17	M – 9 – 6 – 17	Flue gas extraction speed in start phase	START FL GASSPEED	RPM	500 – 2800	2300
Pr18	M – 9 – 6 – 18	Flue gas extraction speed in power 1 work phase	P 1 FLUE GASSPEED	RPM	500 – 2800	1700
Pr19	M – 9 – 6 – 19	Flue gas extraction speed in power 2 work phase	P 2 FLUE GASSPEED	RPM	500 – 2800	1850
Pr20	M – 9 – 6 – 20	Flue gas extraction speed in power 3 work phase – Oven output 1	P 3 FLUE GASSPEED	RPM	500 – 2800	2000
Pr21	M – 9 – 6 – 21	Flue gas extraction speed in power 4 work phase – Oven output 2	P 4 FLUE GASSPEED	RPM	500 – 2800	2200
Pr22	M – 9 – 6 – 22	Flue gas extraction speed in power 5 work phase – Oven output 3	P 5 FLUE GASSPEED	RPM	500 – 2800	2350
Pr23	M – 9 – 6 – 23	Exchanger 1 motor speed in output 1 working mode (NOT USED)	AIR 1 SPEED	Volt	65 – 225	65
Pr24	M – 9 – 6 – 24	Exchanger 1 motor speed in output 2 working mode (NOT USED)	AIR 2 SPEED	Volt	65 – 225	65
Pr25	M – 9 – 6 – 25	Exchanger 1 motor speed in output 3 working mode (NOT USED)	AIR 3 SPEED	Volt	65 – 225	65
Pr26	M – 9 – 6 – 26	Exchanger 1 motor speed in output 4 working mode (NOT USED)	AIR 4 SPEED	Volt	65 – 225	65
Pr27	M – 9 – 6 – 27	Exchanger 1 motor speed in output 5 working mode (NOT USED)	AIR 5 SPEED	Volt	65 – 225	65
Pr28	M – 9 – 6 – 28	Flue gas extractor switch-off threshold (in switch-off phase)	THRESHOL OFF	°C	50 – 180	65
Pr29	M – 9 – 6 – 29	Flue gas extraction speed in brazier cleaning phase	EXHMOTOR CLEANING	RPM	500 – 2800	2800
Pr30	M – 9 – 6 – 30	Screw feed gear motor ON time in cleaning phase	SCREW CLEANING	Seconds	0.1 – 8.0	1,5
Pr31	M – 9 – 6 – 31	Flue gas extractor encoder enable (NOT USED)	ENCODER	On – off	On – off	On
Pr32	M – 9 – 6 – 32	Screw feed brake time	BRAKE TIME	Seconds	0 – 0.5	0,2
Pr33	M – 9 – 6 – 33	Pump activation threshold	PUMP THRESHOL	°C	20 – 70	55
Pr34	M – 9 – 6 – 34	Water pressure switch enable (NOT USED)	WATER MANOSTAT	On – off	On – off	Off
Pr35	M – 9 – 6 – 35	Water pressure threshold (NOT USED)	PRESSURE THRESHOL	Bar	1.5 – 3.0	2,5
Pr36	M – 9 – 6 – 36	Screw feed motor reducer ON time in DHW output working mode	DHW SCREW	Seconds	0.1 – 8.0	6,8
Pr37	M – 9 – 6 – 37	Flue gas intake speed in DHW output working mode	DHW FLUE GAS DEV	RPM	500 – 2800	2350

THREE-WAY CONNECTION LEGEND:

BLUE = COMMON
 BLACK = OPENING PHASE
 BROWN = CLOSING PHASE
 YELLOW/GREEN = GROUND

**CABLE 4 x 0,75 (OPTIONAL)
 FOR MOTORISED THREE-WAY
 VALVE CONNECTION**

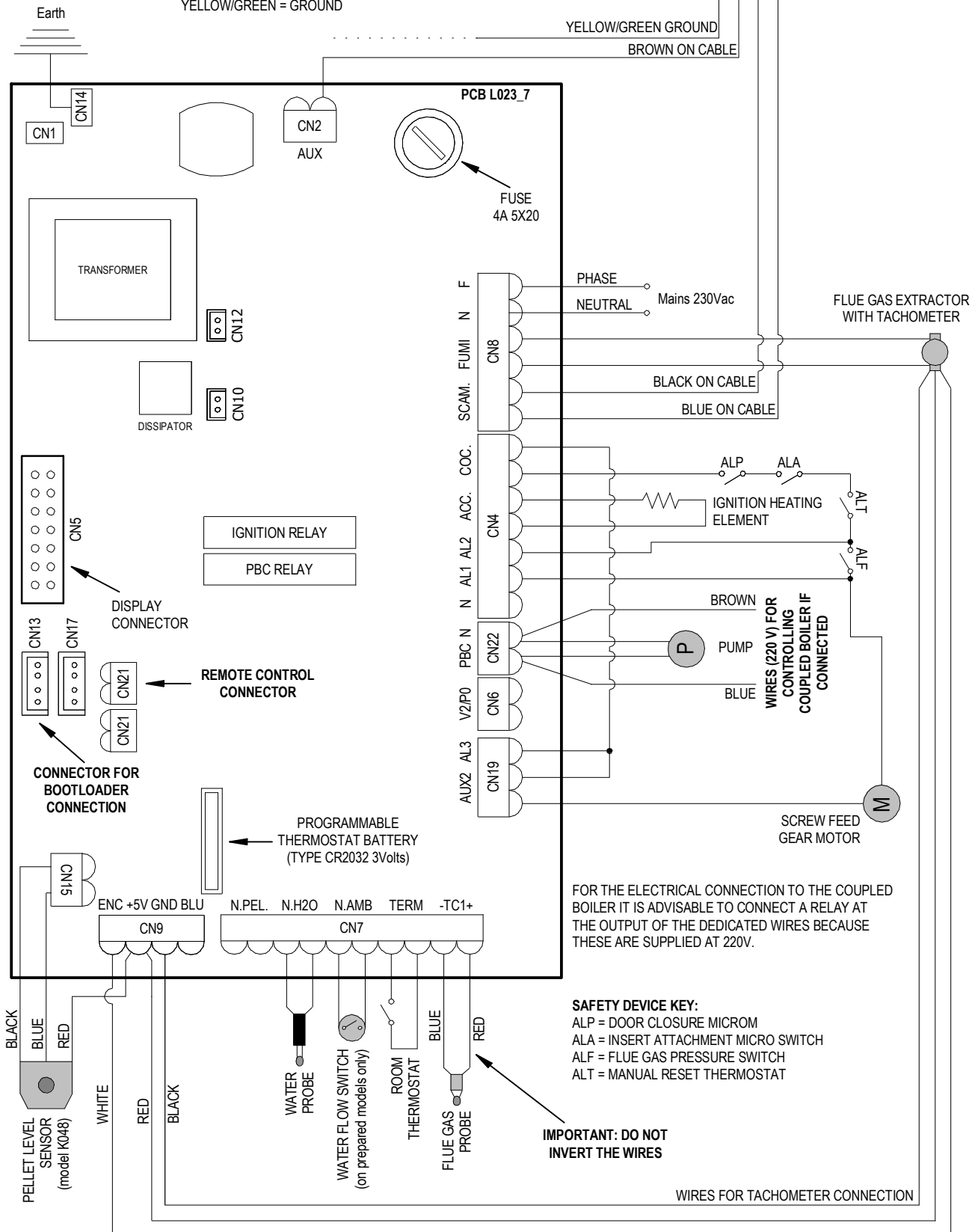

WARRANTY CONDITIONS

The warranty starts from the date of purchase of the product, which must be demonstrated by a delivery document and by the initial start-up report issued by the Authorised Technical Service Centre. These documents must be shown to the Technical Assistance Centre, if required.

- A copy of the initial start-up report issued by the Authorised Technical Assistance Centre must be preserved along with the proof of purchase receipt.
- KLOVER s.r.l. disclaims any liability for accidents resulting from failure to comply with the instructions contained the user and maintenance manual attached to the appliance.
- Furthermore, KLOVER s.r.l. declines any liability arising from misuse of the product by the user, unauthorized modifications and/or repairs, as well as the use of non-original spare parts or parts not suitable for this type of product.

KLOVER s.r.l. guarantees the quality of materials, good construction and functionality of the product for a period of 2 years, under the following conditions:

1. On its own unquestionable judgement, the device evidencing material or construction faults will be repaired or replaced; with the exception of all costs relating to transport, restoration (hydraulic disassembly and assembly operations, any masonry works and any other necessary intervention) and accessory materials.
2. The warranty does not cover:
 - the ceramic glass and ceramic-majolica and/or varnished steel linings, as they are very fragile and can get accidentally damaged;
 - any part made of ceramic-majolica evidencing altered colour shades, pitting, cracks, shading and slight dimensional variations, as these cannot be regarded as product defects but features deriving from the handmade processing techniques used;
 - the cast iron brazier, the cast iron grid and plate, smoke deflector or flame arresters, gaskets, fuses or batteries inside the device's electronic system and any other removable component, where it is not proved that their condition is due to a manufacturing defect rather than the effects of wear;
 - electric and electronic parts, in which the malfunction can be traced to a non-compliant electrical connection, natural disaster (lightning, electrical discharges, etc.) and variation in voltage other than the nominal voltage;
 - any parameter calibration intervention due to the type of fuel or installation of the device.
3. The replaced components are guaranteed for the remaining period of the warranty, starting from the date of purchase and/or for a period not exceeding 6 months.
4. The use of poor-quality wood pellets or other fuel could damage the components of the device thereby voiding the relevant warranty and the manufacturer's liability. Therefore, we recommend using the fuel type indicated in our specifications;
5. Incorrect installation carried out by unqualified personnel, tampering with, failure to comply with the instructions contained in this "use and maintenance manual" and those regarding "workmanlike installation" shall void any warranty rights; the same applies to damages deriving from external factors. At all events, any compensation for direct or indirect damages is excluded, regardless of the nature and cause of the damages.
6. Please bear in mind that the goods travel under the customer's responsibility, even if delivered carriage free, therefore we shall not be held liable for any damages due to loading and unloading operations, accidental knocks, storage in unsuitable places, etc.
7. The boiler unit of water-based products only connected to a heating and/or sanitary water system is guaranteed for 5 years, at the above-mentioned conditions.
8. The warranty is to be considered valid only if the initial start-up report and warranty start is duly completed in all its parts by the Authorised Technical Assistance Centre at the first ignition. For the validity of the warranty, the first ignition must only be carried out by the Authorized Technical Assistance Centre within 3 months from the date of purchase and no later than 30 days from date of installation;

For any disputes the Courts in Verona have sole jurisdiction.

KLOVER
F U O C O E P A S S I O N E

KLOVER Srl

Via A. Volta, 8
37047 San Bonifacio (VR)
VAT No. 02324280235
www.klover.it