

ENGLISH

Main Revision 1.0
FPH_supplement:

Pellet wood- burning thermo-stove DUAL

INSTALLATION, USE, MAINTENANCE
AND HELPFUL TIPS



KLOVER
F U O C O E P A S S I O N E

SERVICE DECLARATION

Ref. Annex III EU Regulation no. 305/2011

DoP/KLOVER-037

- 1. Identification number : **DH**
 - 2. Model and/or lot no. and/or serial no. (Art.11-4) : **DUAL**
 - 3. Intended use of the product according to the relevant harmonised technical specification : **Home heating appliance fuelled by wood pellets and wood logs, which can also produce domestic hot water**
 - 4. Name or trademark of the manufacturer (Art11-5) : **KLOVER s.r.l.**
I - 37047 San Bonifacio (VR) – Via A. Volta, 8
 - 5. Name and address of the representative (Art.12-2) : **-**
 - 6. Assessment and verification system of the performance constancy (Annex 5) : **System 3**
NB 1880
ACTECO s.r.l.
I - 33084 Cordenons (PN) – Via Amman, 41
 - 7. Notified laboratory : **1880-CPR-051-16 / 1880-CPR-051-002-16**
1880-CRP-052-16 / 1880-CPR-052-002-16
- Number of test report (based on System 3) : **1880-CPR-051-16 / 1880-CPR-051-002-16**
1880-CRP-052-16 / 1880-CPR-052-002-16

8. Declared performances

HARMONISED TECHNICAL SPECIFICATION	EN 14785	EN 13240
PERFORMANCE FEATURES	PERFORMANCE	PERFORMANCE
Fire resistance	A1	A1
Distance from combustible material	R200 / L200 / B200 / F800 mm	R200 / L200 / B200 / F1000 mm
Fuel spillage risk	Compliant	Compliant
Emission of combustion products		
- Nominal power	CO at 13% of O2 0.005 %	CO at 13% of O2 0.093 %
- Reduced power	CO at 13% of O2 0.040 %	
Effective temperature	Compliant	Compliant
Electrical safety	Compliant	Compliant
Accessibility and cleaning	Compliant	Compliant
Maximum operating pressure	2.5 bar	2.5 bar
Mechanical strength	NPD (performance not determined)	NPD (performance not determined)
Thermal performance		
- Nominal power (reduced)		
- Nominal power (reduced) yielded to the environment	16.1 kW (4.7 kW) 4.8 kW (1.9 kW)	11.3 kW 4.8 kW
- Nominal power (reduced) yielded to water	11.2 kW (2.8 kW)	6.5 kW
Yield		
- Nominal power	η 93.0 %	η 91.9 %
- Reduced power	η 94.4 %	
Flue gas temperature		
- Nominal power	T 108 °C	T 119.9 °C
- Reduced power	T 55 °C	

9. The performance of the product referred to in points 1 and 2 is compliant with the declared performance in point 8. This declaration is released on the sole responsibility of the manufacturer referred to in point 4.

Signed in the name and on behalf of the manufacturer by:

San Bonifacio (VR), 05/04/2017

Mario Muraro
Chairman of the Board

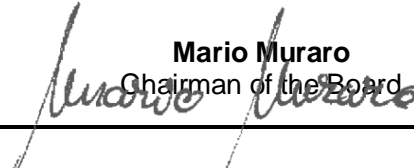

CONTENTS

INTRODUCTION 1
 IMPORTANT SAFETY INSTRUCTIONS 1

THE MACHINE AND THE PELLETS..... 2
 COMPONENTS OF THE APPLIANCE 2
 OVERALL DIMENSIONS 5
 CONNECTIONS DATA SHEET 6
 TECHNICAL SPECIFICATIONS 7
 PELLET PROPERTIES..... 8
 TYPES OF WOOD..... 8

REQUIREMENTS OF THE PLACE OF INSTALLATION 10
 POSITIONING..... 10
 SPACES AROUND AND ABOVE THE APPLIANCE 10
 EXTERNAL AIR INTAKE 10
 THE FLUE AND CONNECTION TO THE SAME 11
 CHIMNEY 13

ELECTRICAL CONNECTION..... 14
 CONTROL OF ANY COUPLED BOILER 14
 CONTROL OF A POSSIBLE THREE-WAY MOTORISED VALVE FOR THE DHW SYSTEM (ON PREPARED MODELS ONLY) 15
 CONNECTION TO THE ROOM THERMOSTAT 16

HYDRAULIC CONNECTION 16

THE DISPLAY 17

THE MENU 20

INITIAL START-UP 24
 FILLING THE BOILER UNIT AND THE SYSTEM FOR THE FIRST TIME..... 24
 ANTIFREEZE PROTECTION 25
 OPERATING PRINCIPLE 25
 IGNITION (WOOD SIDE)..... 25
 BOILING 26
 IGNITION (PELLET SIDE)..... 27
 WORKING MODE FROM POWER 1 TO POWER 5 (PELLET SIDE)..... 28
 SWITCH-OFF CYCLE (PELLET SIDE) 28
 WORKING MODE AT DHW OUTPUT (ON PREPARED MODELS ONLY)..... 29
 MODIFYING THE WORKING POWER..... 29
 CHANGE THE WATER TEMPERATURE OF THE HEATING SYSTEM..... 29
 REMOTE CONTROL..... 30

PROBLEMS, ALARMS, USEFUL ADVICES 30
 USEFUL INFO... 30
 WHAT HAPPENS IF... 31
 ALARM SIGNALS..... 32

CLEANING AND MAINTENANCE..... 32
 PRECAUTIONS BEFORE CLEANING 32
 ORDINARY CLEANING (PELLET SIDE) 32
 ORDINARY CLEANING (WOOD SIDE) 35
 EXTRAORDINARY CLEANING (PELLET SIDE) 35
 EXTRAORDINARY CLEANING (WOOD SIDE)..... 37
 ANNUAL CLEANING..... 38
 CLEANING THE CERAMIC GLASS..... 40
 CLEANING THE FLUE 40
 MAINTENANCE 40
 MAINTENANCE OF THE BOILER UNIT 41

PCB PARAMETERS..... 42

WIRING DIAGRAM 44

WARRANTY CONDITIONS	45
----------------------------------	-----------

Dear client,

First of all we would like to thank you for choosing a “**KLOVER**” product and we hope you will be satisfied with this product.

Please read the warranty certificate carefully. This is found on the last page of this *User Guide*. Please contact the authorised Technical Assistance Centre (TAC) for the initial start-up of your stove and to validate the warranty.

We would like to thank you again for trusting KLOVER products, and we would also like inform you that these models are the result of forty years of experience in the manufacture of solid fuel products using water as heat transfer fluid. Every single detail of the product is manufactured by qualified staff, using the most advanced equipment.

The manual contains a detailed description of the appliance and its operation, instructions for proper installation, basic maintenance and control points, which must be periodically performed; furthermore it contains practical advice which helps to obtain maximum performance from the appliance with minimum fuel consumption.

Stay warm with KLOVER!

Copyright

All rights reserved. The reproduction of any part of this manual, in any form, without the explicit written permission of KLOVER Srl. is forbidden. The content of this manual may be modified without notice. Although the documentation contained in this manual has been carefully compiled and checked, KLOVER srl cannot be held liable for any damages arising from the use of the same.

Copyright © 2017 KLOVER srl

INTRODUCTION

Important safety instructions

Please read these instructions before installing and using the product.

- The installation and initial start-up of the appliance must be performed by skilled personnel trained in the relevant safety standards. They will be responsible for the definitive installation of the appliance and its proper operation. KLOVER srl shall not be held liable if these precautions are not observed.
- During installation of the appliance, all local regulations - including those referring to national and European Standards - must be observed.
- Connect the flue gas outlet to a flue with the specifications described in the "Flue and its connection" section of this User guide.
- The appliance is not suitable for installation on a shared flue system.
- If the flue should catch fire, use appropriate fire extinguishing equipment or call the fire brigade.
- Connect the product to an earthed power socket. Avoid using sockets controlled by switches or automatic timers.
- Do not use the power supply cable if damaged or worn.
- If a multiple socket is used, make sure that the total voltage of the connected devices does not exceed the rated voltage for the socket. Also make sure that the total voltage of all the devices connected to the socket does not exceed the maximum permitted level.
- Do not use flammable substances to clean the appliance or its parts.
- Do not leave flammable containers and substances in the place where the appliance is installed.
- The appliance works exclusively with wood pellets and logs and only with the hearth door shut.
- NEVER open the pellet-side door of the appliance during normal operation.
- The use of poor quality pellets or wood or any other material can damage the appliance operation, voiding the warranty and exempting the manufacturer from all liability.
- Do not use the appliance as an incinerator or for any use other than that for which it was designed.
- Do not use fuels other than those recommended.
- Do not use liquid fuels.
- The appliance, and its outer surfaces in particular, become very hot to the touch during operation; handle with caution in order to avoid burns.
- Only use original spare parts recommended by the manufacturer.
- Do not make any unauthorised modifications to the appliance.
- Do not touch the hot components of the product (ceramic glass, flue pipe) during normal operation.
- Never touch the appliance if you are barefoot and/or if you have wet or damp parts of the body.
- Use the appropriate button to switch off the electrical panel. Do not disconnect the power supply cable while the appliance is operating.
- During the ignition phase and normal operation of the appliance, maintain the necessary safety distance and do not remain standing in front of it.
- Keep children away from the appliance when it is running since they could get burned by touching its hot components.
- Do not leave the packaging elements within reach of children or unassisted disabled persons.
- Children and inexperienced people must not be allowed to use the appliance.
- Do not use the appliance in ways other than those indicated in this user guide.
- The appliance is designed for indoor use only.
- This user guide constitutes an integral part of the appliance. If the product is sold to another user, this manual must be passed on to the new owner.

KLOVER S.R.L. DECLINES ALL LIABILITY IN CASE OF ACCIDENTS DUE TO FAILURE TO COMPLY WITH THE SPECIFICATIONS OF THIS MANUAL.

KLOVER S.R.L. DECLINES ALL LIABILITY DUE TO INCORRECT USE OF THE PRODUCT BY THE USER, UNAUTHORISED MODIFICATION AND/OR REPAIRS, AND USE OF NON-ORIGINAL SPARE PARTS OR SPARE PARTS NOT SPECIFICALLY DESIGNED FOR USE ON THIS PRODUCT MODEL.

KLOVER S.R.L. SHALL NOT BE HELD LIABLE FOR THE STOVE'S INSTALLATION. THE INSTALLER IS THE SOLE PARTY RESPONSIBLE FOR THIS OPERATION AND IS ALSO ENTRUSTED WITH CHECKING THE FLUE, EXTERNAL AIR VENT AND THE CORRECTNESS OF THE PROPOSED INSTALLATION SOLUTIONS. ALL THE

SAFETY REGULATIONS SET OUT IN THE SPECIFIC LAWS IN FORCE IN THE COUNTRY WHERE THE MACHINE IS INSTALLED MUST BE OBSERVED.

NON-ROUTINE MAINTENANCE MUST ONLY BE PERFORMED BY AUTHORISED AND QUALIFIED STAFF.

To ensure the validity of the warranty, the user must comply with the instructions contained in this guide and, in particular, must:

- Use the appliance within its operating limits;
- Regularly perform all maintenance activities;
- Authorise expert and competent people to use the appliance.

Failure to comply with the instructions contained in this guide shall automatically void the warranty.

THE MACHINE AND THE PELLETS

Components of the appliance

The table below shows the standard features of the appliance:

Expansion tank	8 l
Safety valve	2.5 bar
Pressure gauge	0 – 4 bar
Check valve	Yes
Automatic air vent valve	Yes
Heating system pump	Yes. Mod.25/70
Recirculation pump	Yes. Mod.25/70
Heating exchanger	Yes
DHW heat exchanger	On prepared models only
System loading cock	Yes
Boiler unit loading cock	Yes
Electrical setting for the connection of the domestic water flow switch	Yes
Infrared remote control	Yes

The appliance is delivered with the following equipment:

- No. 1 user, installation and maintenance guide;
- No. 1 power supply cable;
- No. 1 brush D.40-170 mm L.420 mm.
- No. 1 brush D.80-120 mm L.1280 mm.
- No. 1 fireside poker;
- No. 1 infrared remote control;
- No. 1 bottle 1 l “LONG LIFE” protective.

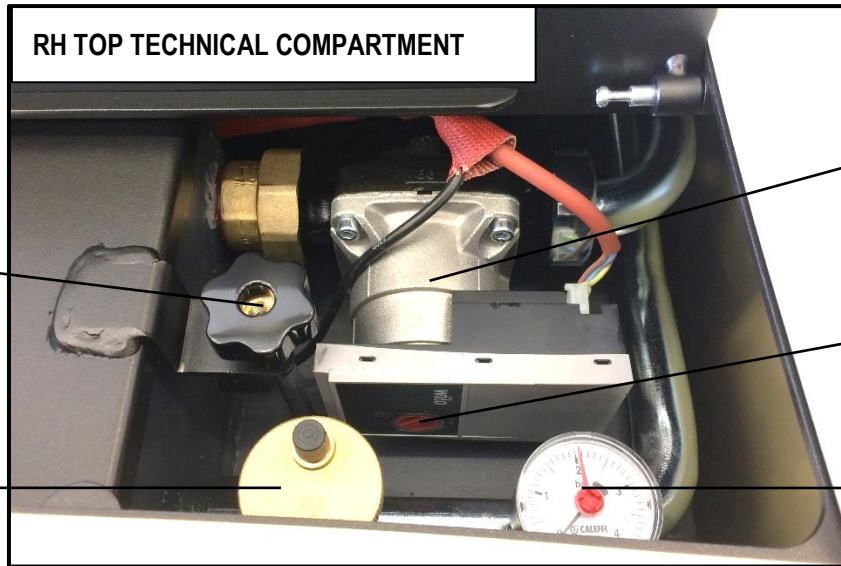

RH knob for opening the inspection cover SICURO TOP

Automatic air vent valve (Jolly).

High-efficiency circulating pump for heating system.

Circulating pump speed switch.

Pressure gauge (indicates the pressure of the heating system).

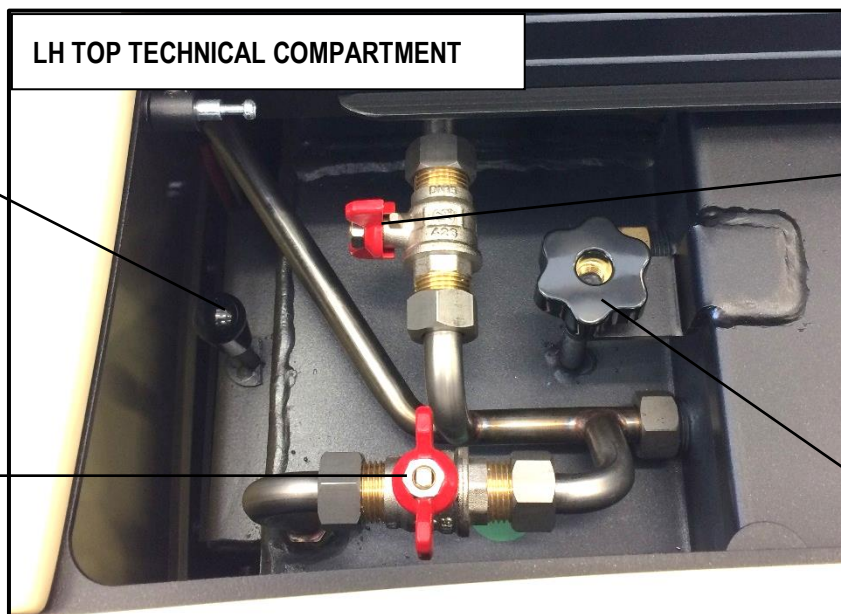

Left side flue gas pass scraper.

Boiler unit loading cock.

System loading cock.

LH knob for opening the inspection cover SICURO TOP



Boiling discharge pipe Sicuro top.

Secondary exchanger (DHW).

Primary exchanger (heating).

Level switch (water level sensor).

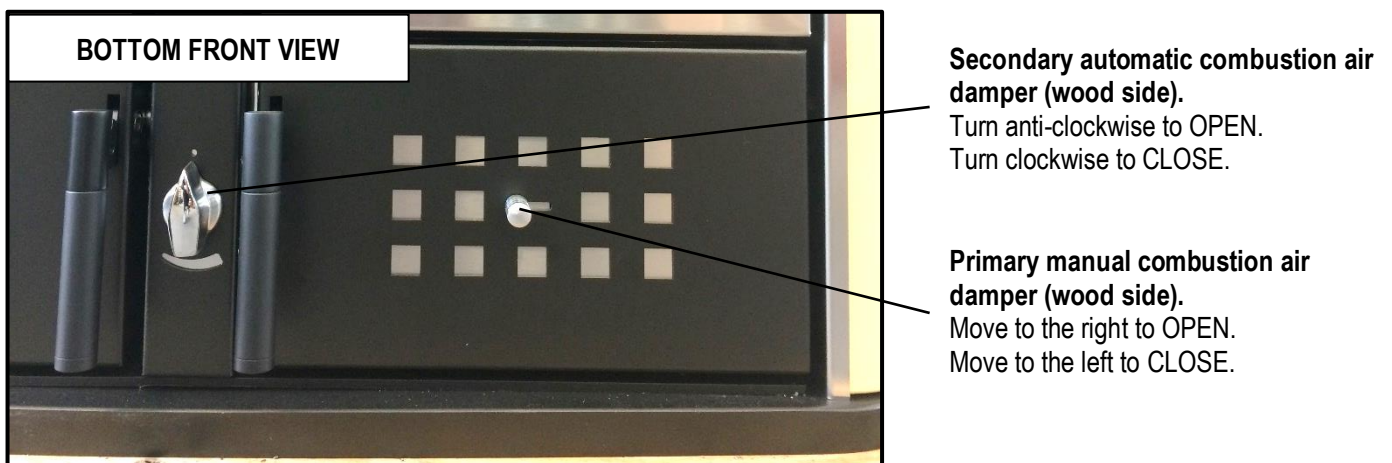
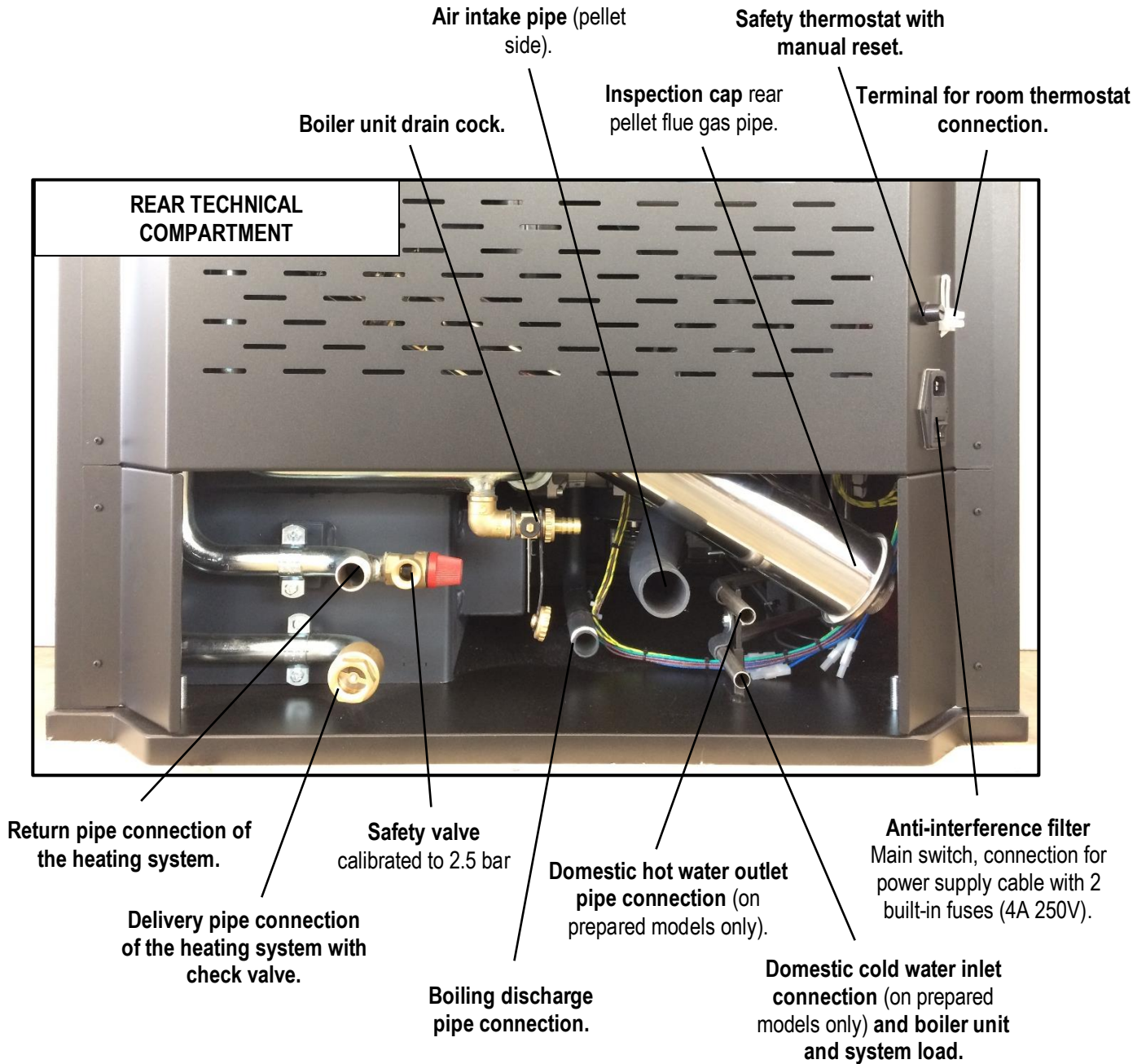

Overall dimensions

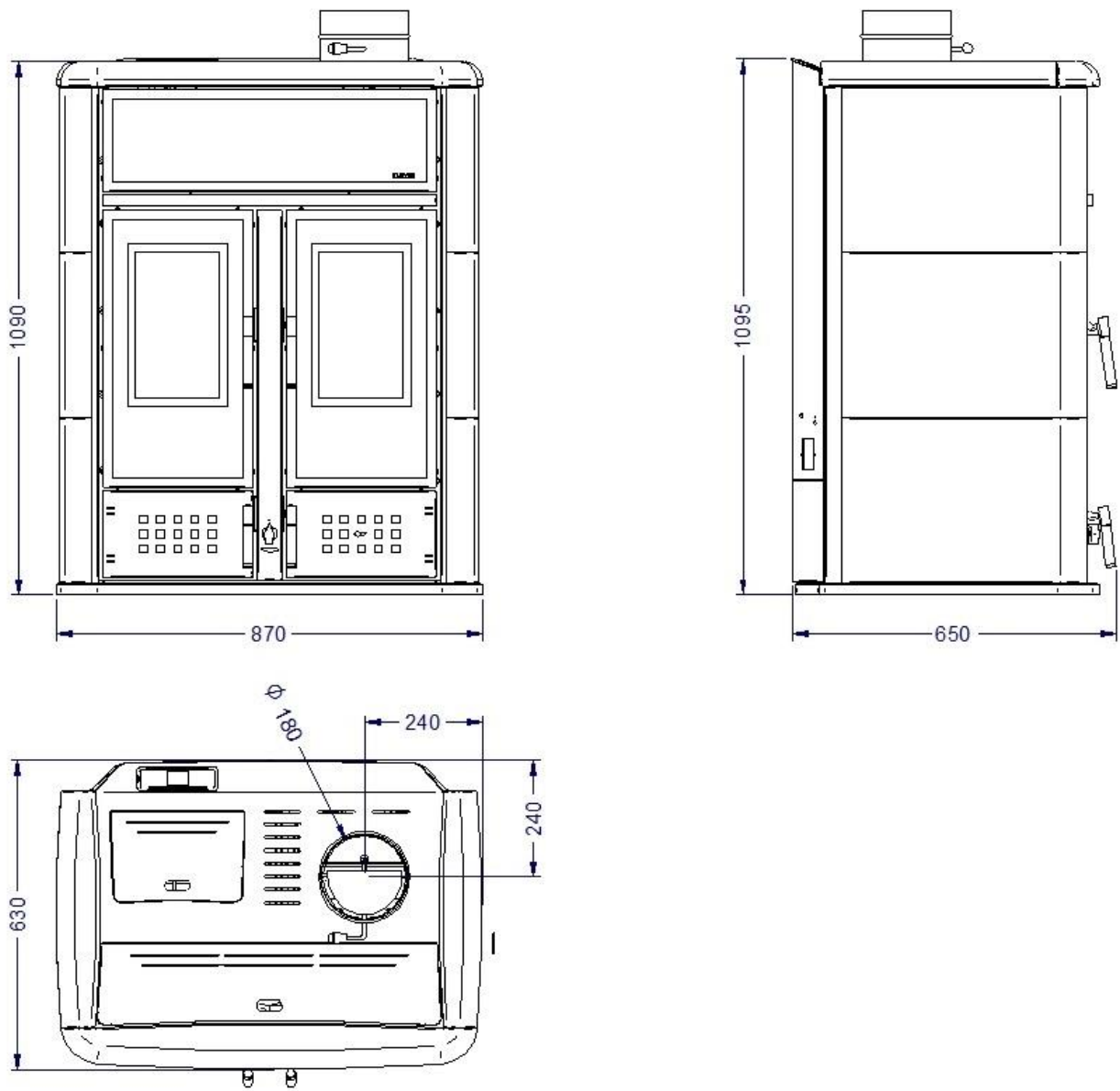

Connections data sheet

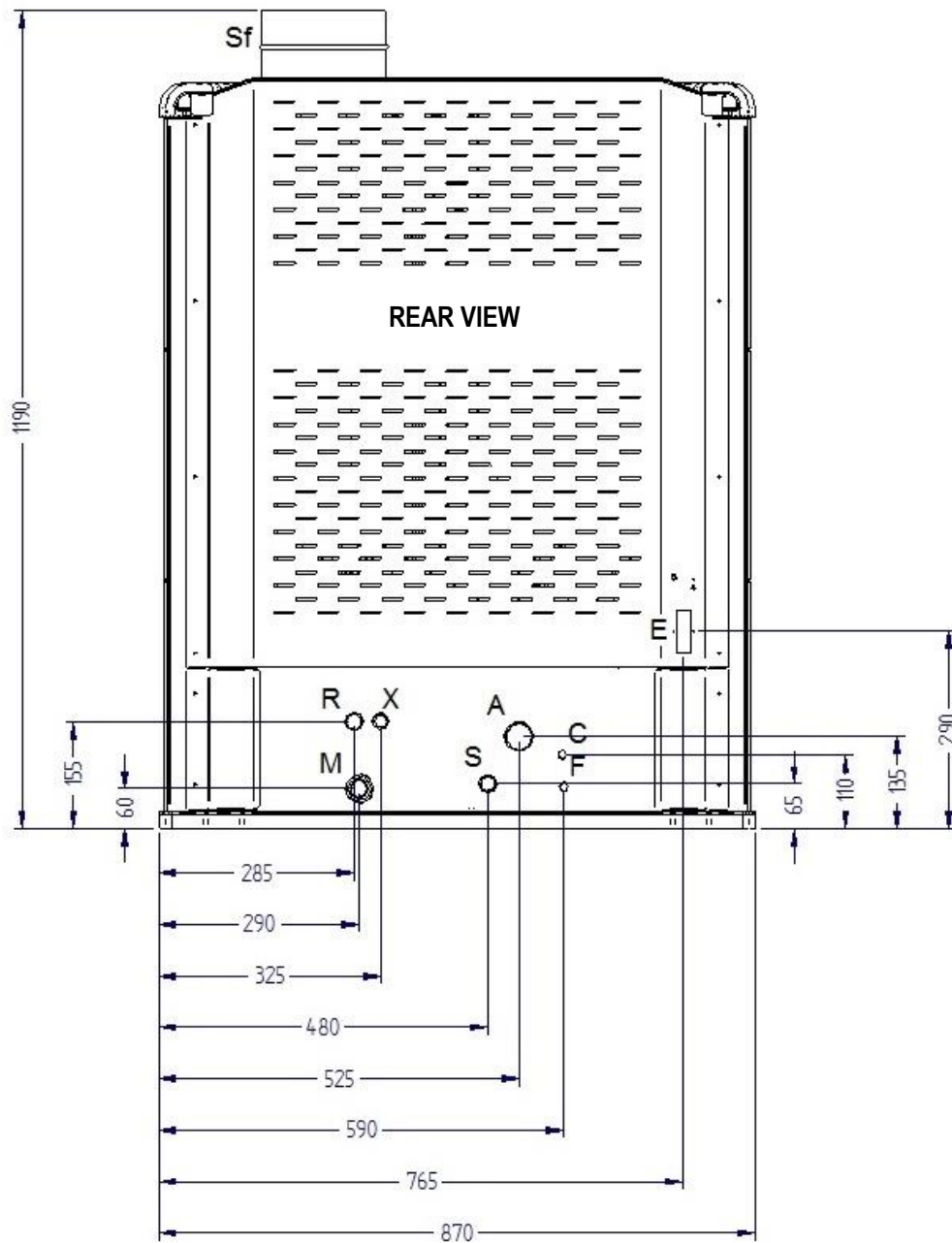

Description of connections	
M = System Delivery	3/4" F
R = System Return	3/4" M
F = Domestic cold water inlet (on prepared models only) and boiler unit and system load	14 mm
C = Domestic hot water outlet (on prepared models only)	14 mm
X = Safety valve drain	1/2" F
S = Boiling discharge	3/4" M
A = Intake pipe	43 mm
Sf = Flue gas outlet	180 mm M
E = Electricity connection	

Technical Specifications

Total nominal heat capacity	kW (Kcal/h)	29.6 (25,550)
Pellet nominal heat capacity	kW (Kcal/h)	17.3 (14,900)
Wood nominal heat capacity	kW (Kcal/h)	12.3 (10,600)
Total nominal thermal power	kW (Kcal/h)	27.4 (23,500)
Pellet nominal thermal power	kW (Kcal/h)	16.1 (13,800)
Wood nominal thermal power	kW (Kcal/h)	11.3 (9,700)
Total power delivered to heating water	kW (Kcal/h)	17.7 (15,200)
Pellet power delivered to heating water	kW (Kcal/h)	11.2 (9,600)
Wood power delivered to heating water	kW (Kcal/h)	6.5 (5,600)
Total power delivered to room due to radiation	kW (Kcal/h)	9.6 (8,200)
Pellet power delivered to room due to radiation	kW (Kcal/h)	4.8 (4,100)
Wood power delivered to room due to radiation	kW (Kcal/h)	4.8 (4,100)
Pellet efficiency at nominal power (reduced)	%	93 (94)
Wood efficiency at nominal power	%	91.9
Nominal voltage	V	230
Nominal frequency	Hz	50
Expansion vessel litres/preloading bar		8 / 1
Maximum operating/recommended pressure	bar	2.5 / 1.5
Flue outlet diameter	mm	180
Air intake pipe diameter	mm	43
CO at 13% oxygen pellet at (reduced) nominal output	%	0.005 (0.04)
CO at 13% oxygen wood at nominal output	%	0.093
Pellet chimney minimum draught	Pa	10.7
Wood chimney minimum draught	Pa	6.2
Pellet combustion gas flow	g/s	12
Wood combustion gas flow	g/s	6.6
Pellet exhaust flue gas temperature	°C	107.8
Wood exhaust flue gas temperature	°C	119.9
Pellet tank capacity	Kg	30
Pellet min – max hourly consumption	Kg/h	1 – 3.4
Hourly wood consumption	Kg/h	2.8
Boiler unit capacity	litres	50
Width	mm	870
Height	mm	1100
Depth	mm	630
Minimum safety distance pellet side from flammable materials (side / rear / front)	mm	200 / 200 / 800
Minimum safety distance wood side from flammable materials (side / rear / front)	mm	200 / 200 / 1000
Weight	Kg	330

* Power consumption only during the ignition cycle.
The appliance's heat output may vary depending on the type of wood and pellets used.

Pellet properties

The appliance has been tested with all types of pellets available on the market. The pellets must have the following properties:

- Diameter 6 mm.
- Maximum length 35 mm.
- Maximum humidity content 8 – 9 %.
- 100% wood. Totally additive-free.
- Maximum ash residue 1.1 %.

To obtain good performance from the appliance, we recommend using good quality pellets. **Pellets should be poured into the tank using a shovel, and not directly from the bag.**

Good quality pellets should have the following properties:

- Constant diameter cylinders with a smooth, shiny surface;
- There should not be a lot of sawdust inside the packaging;
- After grabbing a bunch of pellets and placing them into a container filled with water, good-quality pellets will sink and poor-quality ones will tend to float;
- The quality certification data, in particular conformity to international standards such as EN14961-2, DIN 51731 and O-NORM M7135, should be indicated on the packaging;
- The packages should be intact since pellets tend to absorb humidity. Humidity not only reduces the calorific value and increases the amount of flue gases expelled, but also causes swelling of the product which may create problems with the appliance.

The production of pellets must be compliant with some international standards (such as EN14961-2, DIN 51731 and O-NORM M7135) which establish minimum values for quality checks on pellets. To facilitate the right choice of the combustible material you can find below one of the most common certification marks identifying the quality of the pellets:

Indication of the standard,
base reference for the quality
classes EN*plus*

**Indication of the quality
class of the certified pellet**
(preferable A1)



IT xxx

Code of the certified company
consisting of two elements:

- Symbol of the country of production (example "IT")
- Progressive number assigned at the acquisition of the certification (example "xxx")

The use of poor quality pellets or any other material can damage the appliance operation, voiding the warranty and exempting the manufacturer from all liability.

In order to guarantee trouble-free combustion, the pellets must be stored in a dry place.

Types of wood

Wood is one of the most precious materials offered by nature. For heating purposes, it must be verified that the features of the wood satisfy some important requisites that must not be ignored, the most important of which is without a doubt the correct seasoning or drying, in other words the wood must have the correct amount of humidity, around 10-15%, therefore also the period of the year in which it is felled becomes important. This should coincide with the winter period. Correct seasoning (at least 2 years) provides fuel with an excellent yield that is not very pollutant.

It must be kept in covered, well-aired places, already cut into pieces of a suitable size for the appliance.

The wood is divided into softwood and hardwood on the basis of the weight kg of a cubed metre of material. Softwoods weighing 300-350 kg/m³ include fir, pine, poplar, European alder, chestnut and willow, while hardwoods weighing 350-400 kg/m³ include beech, ash, elm, acacia and oak.

Softwood ignites easily, burns quickly, produces a long flame and is used in ovens requiring a long flame pass.

Hardwood is more compact, the combustion is slower with short flame, it lasts longer and is more suitable for domestic

central heating.

The wood to be burned for heating purposes has different features according to the plant variety from which it is obtained. Not all woods are equal, and the drying time and the calorific value vary from plant to plant. The calorific value depends on the humidity and density of the wood. Top quality woods are beech, ash, elm and acacia. **Avoid resinous woods as they reduce the appliance's service life.**

Resinous woods generate a lot of soot and require the flue and the appliance to be cleaned more frequently. The calorific value of the different types of wood depends greatly on their humidity and consequently the power of the appliance is directly affected by the type of wood used, on average a well-seasoned wood has a calorific value of 3200 kcal/kg.

Calorific value of wood in relation to humidity:

% of humidity	Calorific value kcal/kg
15%	3490
20%	3250
25%	3010
30%	2780
35%	2450
40%	2300

CALORIFIC VALUE of the wood means the amount of heat yielded during combustion, referring to the unit quantity of the material burned.

The calorific value of a wood species depends on the presence of **lignin** (6000 Kcal/kg) or **cellulose** (4000 Kcal/kg) as well as the abundance of **resin** (8500 Kcal/kg).

The calorific value per unit of weight (= absolute) is highest in Conifers.

- Absolute calorific value of conifers: 4700 Kcal/kg
- Absolute calorific value of broad-leaved species: 4350 Kcal/kg.

On the other hand the **SPECIFIC WEIGHT** of the "broad-leaved species" is greater; therefore with equal volumes introduced into the appliance, both the weight and amount of heat available for combustion are greater; in practice the relative calorific value is higher (referring to a unit of volume).

For example: the calorific value of the white fir is practically the same as that of the oak, but the oak has a specific weight that is twice that of the fir. Therefore half the volume of oak must be introduced into the appliance in order to have the same "heat" obtained from the fir.

	*Calorific value (Kcal/Kg)	**Specific weight (Kg/m3)
WHITE FIR	4650	440
RED FIR	4857	450
MAPLE	4607	740
BIRCH	4968	650
BLACK ELM	4640	820
CHESTNUT	4599	580
TURKISH OAK	4648	900
CYPRESS	5920	620
BEECH	4617	750
ASH	5350	720
HOLM OAK	/	960
LARCH	4050	660
EUROPEAN ALDER	4700	530
FLOWERING ASH	/	760
PLANE TREE	/	690
CYPRESS POPLAR	4130	500
FALSE ACACIA	4500	790
DOWNY OAK	4631	880

* theoretical absolute value.

** wood seasoned in the air; residual humidity 12-15 %.

REQUIREMENTS OF THE PLACE OF INSTALLATION

Positioning

The initial phase for best installation of the appliance is to determine its optimum location; the following elements need to be considered:

- The possibility of creating an external air vent;
- The possibility of creating a straight flue, preferably coaxial to the outlet of the appliance;
- The possibility of creating piping required for the boiling discharge;
- Proximity to the main water drain and/or the boiler (if one already exists);
- Proximity or ease of connection to the water system;
- Ease of access for cleaning the appliance, the flue gas exhaust pipes and the flue.

The unit must be installed on a floor with a suitable load capacity. If the existing building does not fulfil this requirement appropriate measures (e.g. load distribution plate) must be taken.

The minimum safety distance from flammable materials must be at least 200 mm from the sides and back of the appliance and at least 800 mm with burning mode and 1000 mm with wood burning mode from the front of the appliance.

Relocating the appliance should not be done by forcing on the handle, glass or ceramics.

The installation must guarantee easy access for cleaning the appliance, the flue gas exhaust pipes and the flue, and any subsequent maintenance operation by the Authorised technical assistance centre.

Once you have found the best location for the appliance, position it following the instructions given below.

Spaces around and above the appliance

The figure below shows the minimum distances from walls or other not-easily-removable furniture, that need to be taken into consideration when positioning the appliance.

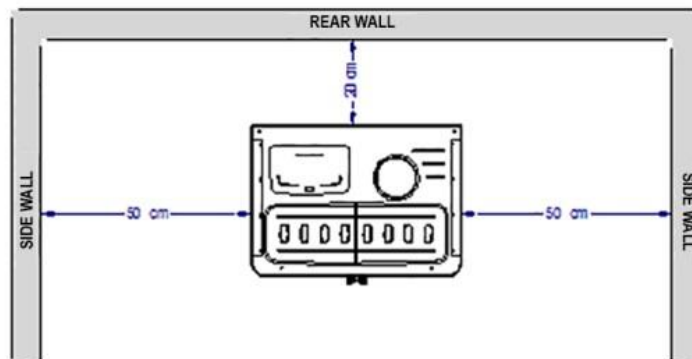

Any shelves or false ceilings mounted above the appliance must be at least 110 cm away from the top part of it.

Furniture and movable objects must be positioned at least 15 cm from the side surfaces of the appliance; these objects must be moved when performing maintenance on the appliance.

Protect all structures that can catch fire against the radiated heat of the fire.

Any extra intervention by the Authorised technical assistance centre, where it is necessary to disconnect the device from the system, will not be recognised under warranty as described in chapter "Warranty Conditions".

External air intake

During operation, the appliance takes in air from the environment in which it is installed; It is therefore essential that this air is replaced through an external air vent. The absence of the air vent may affect the flue draught and therefore the combustion and the safety of the appliance.

Therefore **it is mandatory** to install an external air vent with a minimum completely free passage of **at least 100 cm²** (round hole with minimum diameter of 20 cm protected with a special fixed large mesh grid).

If the wall behind the appliance is on the outside, we recommend you make the hole near it at about 20 cm above the ground (see example in Fig. A).

If it is not possible to put an air vent in the wall behind the appliance, make a hole in a perimeter wall in the room where it is installed. If it not possible to put the external air vent in the same room as where the appliance is installed, this hole can be made in an adjoining room as long as this room communicates permanently, by means of a transit hole (15 cm minimum diameter).

The hole must be protected externally with a fixed grille. The protective grille must be checked periodically to ensure that it is not obstructed, thereby impeding the passage of air. **Therefore keep the air vents clear of obstructions.**

The UNI 10683 Standard FORBIDS the drawing of combustion air from garages, warehouses storing combustible materials, or from business premises with a fire hazard.

Do not connect the external air vent directly to the appliance through piping. If there are other heating or extraction devices inside the room, the air vents must guarantee a sufficient amount of air for properly operating all the devices.

Only sealed appliances (e.g. C type gas appliances, according to the UNI 7129 Standard) or appliances that do not cause a lower pressure compared with the external environment can pre-exist or be installed in the place where the appliance is installed.

Extractor fans can cause malfunctions to the appliance if used in the same room.

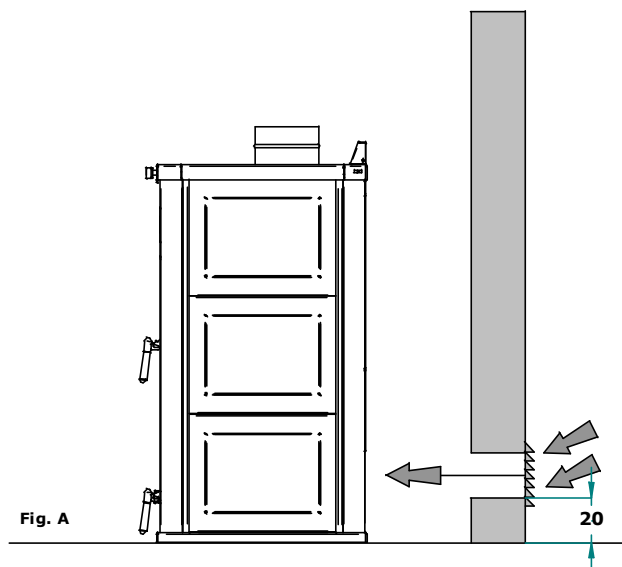

Fig. A

The flue and connection to the same

The flue is an essential element for the efficient operation of the appliance. The flue must have a minimum cross-sectional area as that indicated in the technical specifications of the appliance (180 mm). Each product must be equipped with its own flue, without other adjoining elements (boilers, chimneys, stoves, etc.). The flue dimensions are closely related to its height, which must be measured from the appliance flue gas outlet to the base of the stack. In order to guarantee adequate draught, the surface of the chimney flue outlet must be double the flue cross-section. The discharge pipe for combustion products generated by the forced draught device, must comply with the following requirements:

- It must seal off the combustion gases, as well as being waterproof and suitably isolated and insulated in relation to the conditions of use (refer to UNI 9615);
- It must be made of suitable materials capable of withstanding normal mechanical stress, heat, and the effects of combustion gases and condensate, if any;
- It must go upwards after the vertical section, for the entire remaining part, with a minimum gradient of 20%;
- It must preferably have a round internal cross-section: square or rectangular cross-sections must have rounded corners with radius not inferior to 20 mm;
- It must have a constant, free and independent internal cross section;
- Rectangular cross-sections must have a maximum ratio of 1.5 between the sides;

- **If the flue is installed externally, it must be insulated** in order to prevent the flue gases from cooling and allowing condensation to form;
- Parts made from non-combustible materials (**it is absolutely prohibited the use of aluminium flue**) - capable of withstanding combustion gases and potential condensation - must be used for mounting the flue gas pipes (for the section from the appliance to the flue inlet);
- It is forbidden to use fibre cement pipes to connect the appliance to the flue;
- Flue gas conduits must not pass through rooms in which the installation of combustion devices is prohibited;
- The flue gas conduits must be assembled in such a way as to guarantee adequate sealing of flue gases during low pressure operation of the appliance;
- **The installation of horizontal sections is prohibited;**
- **It is prohibited to use counter sloping elements;**
- The flue gas pipe must allow for the recovery of soot or be cleanable, and must have a constant cross-section;
- It is forbidden to allow other air intake conduits and system pipes to transit inside the flue gas pipes, even if they are over-sized.

Below are examples of pipe connections to the flue:

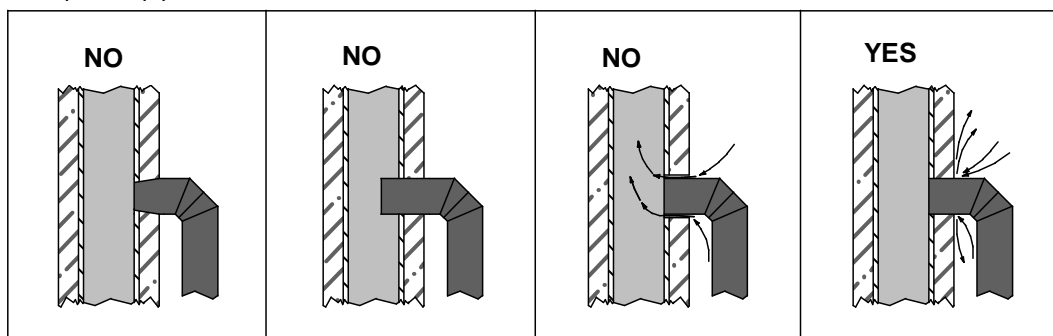

FURTHER SPECIFICATIONS TO BE CONSIDERED

- The flue pipes inside the installation room must be made of a suitable material ([see current regulations](#)) and with a minimum diameter of 180 mm.
- **The pipes must have a double wall (thermally insulated) or be suitably insulated with rock wool. The maximum temperature of the flue pipe inside the room must not exceed 70°C.**
- **IT IS MANDATORY TO HAVE AN INITIAL VERTICAL SECTION OF AT LEAST 0.5 MT IN ORDER TO GUARANTEE CORRECT FLUE GAS DISCHARGE.**
- Every direction change must be carried out with a T-shaped fitting and inspection cap. Secure the pipes to the wall using suitable metal collars in order to prevent any vibrations.
- **IT IS STRICTLY FORBIDDEN TO INSTALL DRAUGHT REGULATION VALVES (BUTTERFLY VALVES).**

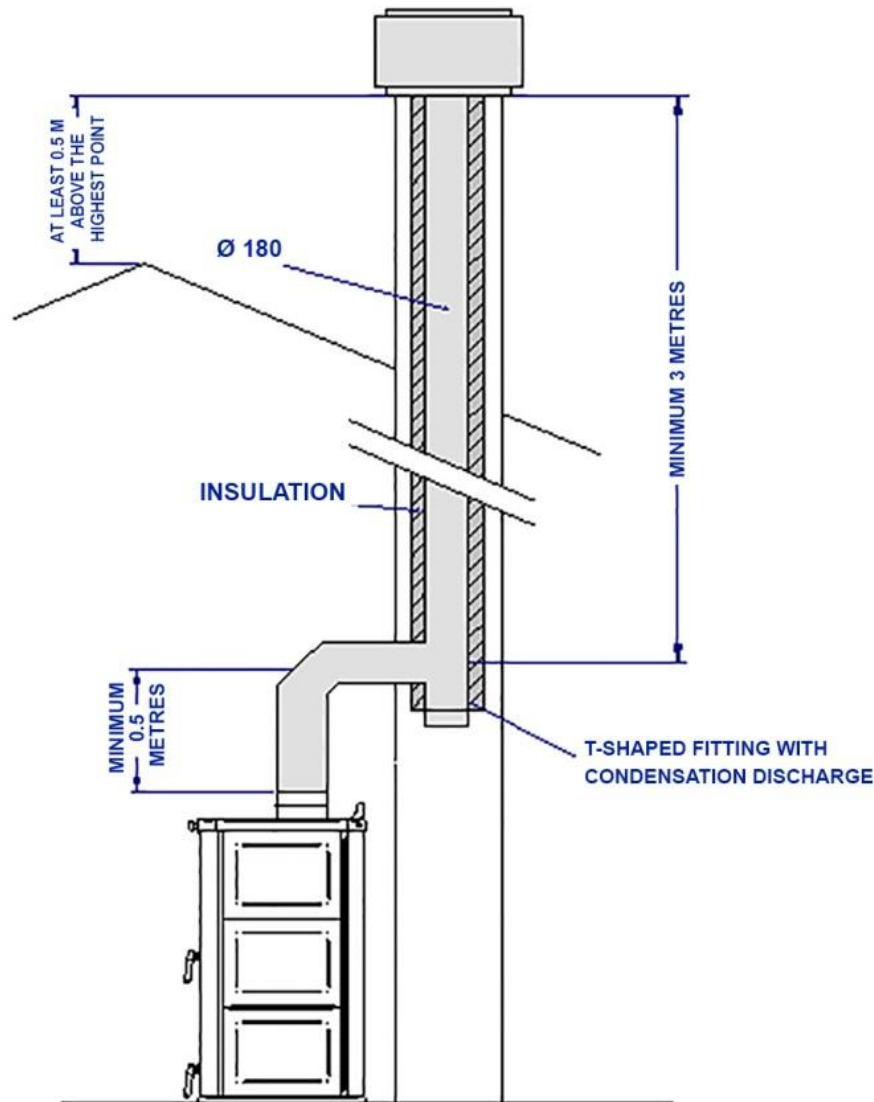

The flue must not have any horizontal sections. The flue must be made with 180 mm diameter stainless steel pipe, suitably insulated and isolated.
The connection to the flue must be sealed.

When assembling the flue, there must be no more than 2 direction changes, including the initial T-shaped fitting.

Chimney

The **chimney** is a device crowning the flue, used to ease dispersion of combustion products. It must satisfy the following requirements:

- It must have a usable outlet cross-section no less than double that of the flue onto which it is inserted;
- It must be shaped in such a way as to prevent rainwater or snow from entering the flue;
- It must be built in such a way as to ensure the discharge of combustion by-products even in the event of winds from every direction and inclination.

The outlet height (where height refers to the top of the flue, regardless of any chimney stacks) must be outside of the so-called reflux zone, in order to prevent the formation of counter-pressures preventing the free discharge of combustion by-products into the atmosphere.

It is therefore necessary that the minimum heights - indicated in the following diagrams - are observed:

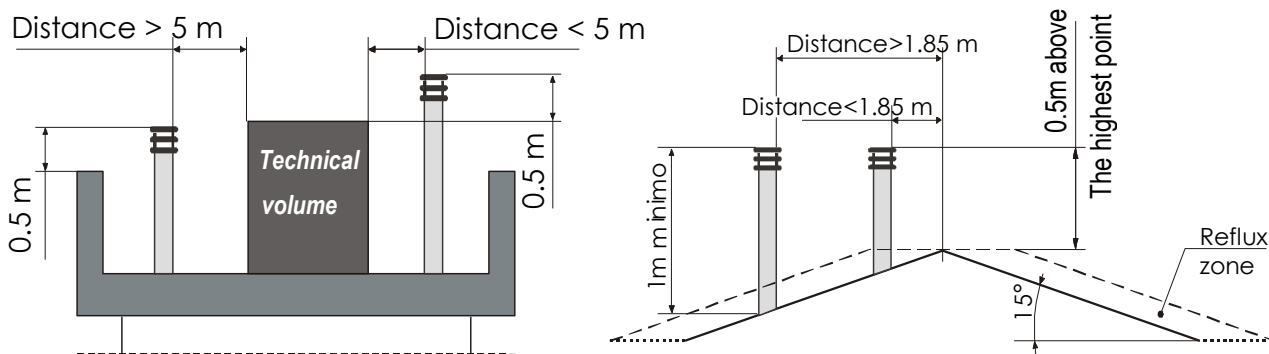

ELECTRICAL CONNECTION

The electric connection must only be performed by **qualified staff**, in compliance with all general and local safety standards.

Check that the power supply voltage and frequency correspond to 220V – 50 Hz.

The appliance’s safety is ensured when it is properly connected to an efficient earthing system.

In the electric connection to the mains power supply, include a 6 A – Id 30 mA differential trip-switch with suitable breaking load. The electric connections, including the earth connection, must be made after shutting off the electrical system.

When completing the system, bear in mind that the cables must be laid in an unmovable manner and far from parts subject to high temperatures. During the final wiring of the circuit, only use components with a suitable electrical protection rating. Do not pass electric cables in the immediate vicinity of the flue gas pipe, unless they are insulated with suitable materials.

KLOVER srl declines all responsibility for injury to persons and animals or damage to objects due to failure to connect the appliance to earth or to comply with IEC specifications.

Control of any coupled boiler

If the pellet appliance is to be coupled with a previously installed boiler in the system (e.g. wall-hung gas boiler), you must ensure that the standard boiler stops when the pellet appliance takes over the heating of the system. The electrical setting, which is accessible from the *rear technical compartment*, intervenes on the standard boiler when the heating circulating pump of the pellet appliance starts up so as to avoid having two boilers operating simultaneously on the same system. The coupled boiler is however always available for the production of domestic hot water.

The two wires prepared on the back of the appliance (blue and brown wires) will have an output voltage of 220 V when the pellet appliance pump is working, and no voltage when the pump stops.

It is therefore necessary to connect the 2 wires to a relay that will control the Room Thermostat (R.T.) input of the coupled boiler (see the following example).

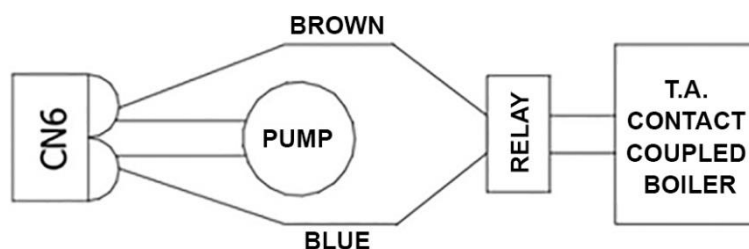

Control of a possible three-way motorised valve for the DHW system (on prepared models only)

The pellet appliance is equipped as standard with a control for a possible 3-way motorised valve to be installed on the domestic water circuit (*for prepared models only*). In the rear technical compartment of the appliance there are four wires with fastons protected by a red seal, which can be used for controlling the valve (*see also "wiring diagram"*). The four wires have different colours, and precisely:

- Blue wire = 3-WAY VALVE COMMON
- Black wire = PELLET APPLIANCE SANITARY SIDE
- Brown wire = GAS BOILER SANITARY SIDE
- Yellow/green wire = GND

Below there is an example of a connection using a 3-way valve with spring return. Remember that the hydraulic connection must be made in such a way that when the valve is at rest, the water passes from the gas boiler. Only when the appliance temperature is sufficient (*see "Menu 5 – Three-way valve threshold"*), the three-way valve is powered, closing the gas boiler water circuit and opening the water circuit of the appliance.

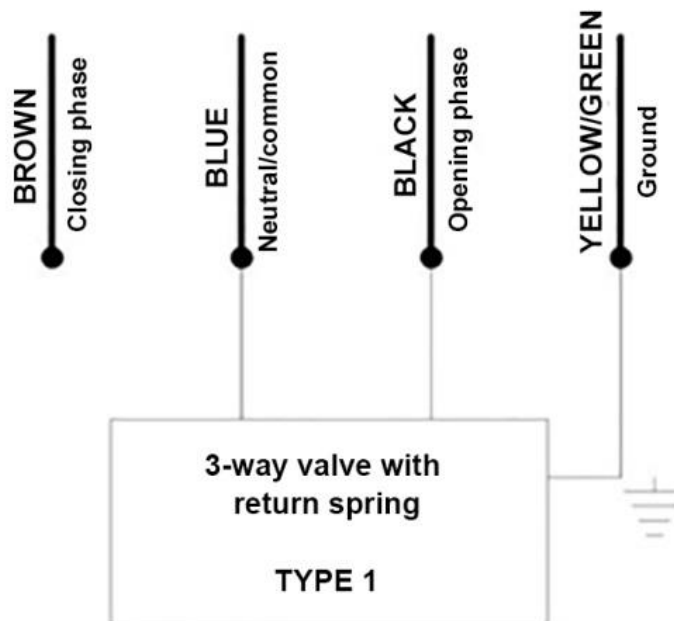

N.B.: in the example above, the brown wire can be used to control a service relay.

Connection to the room thermostat

On the back of the appliance there is a bridged terminal which is used to connect the environment thermostat that will command the operation.

OPERATING PRINCIPLE

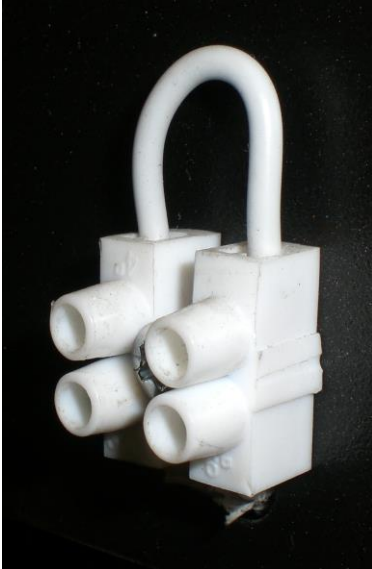

Open contact:

- The appliance switches directly to economy mode operation “T-OFF ECONOMY” thus minimising its operating power.
- The heating circulating pump of the appliance switches off.
- The temperature in the boiler increases due to thermal inertia until it reaches the temperature set with “SET H2O” and displays “T-H2O ECONOMY” on its monitor.
- The appliance now switches itself off automatically if at least one of the following conditions occurs:
 - If it remains in Economy mode Operation “T-H2O ECONOMY” for a time set on Pr44 (30 minutes as default setting).
 - If it exceeds the temperature differential set on Pr43 (set as default at 5°C), in other words if $\text{Temperature H2O} > (\text{“SET H2O”} + \text{Pr43})$.
- The appliance will switch on again automatically if both of the following conditions occur:
 - The contact of the room thermostat closes.
 - The temperature falls below the temperature differential set on Pr43 (set as default at 5°C), in other words $\text{H2O Temperature} < (\text{“SET H2O”} - \text{Pr43})$.

If the above condition occurs during the switch-off cycle, please wait until the cycle is complete.

The room thermostat is deactivated when the wood side is on.

N.B.: If the water temperature exceeds the threshold set on Pr50 (set as default at 83°C), the circulating pump of the system is forcedly switched-on to ensure the disposal of excessive heat, thus avoiding the reaching of high temperatures of the water in the boiler. For this reason it is recommended that the heating system is not entirely closed.

ATTENTION: If the room sensor in the “Remote Control” is also enabled (see “Menu 04 – Enable R.T. Contact”) the appliance enters the economy mode when both instances are satisfied.

HYDRAULIC CONNECTION

The plumbing connections must be made in a rational way using the connections on the template of the appliance. To facilitate the connection of the pipes, all the plumbing connections have been fitted on the rear side, leaving space to make the appropriate connections.

The appliance can be coupled with any other boiler already installed on the system. In this case it is essential to fit all the necessary safety devices and shut-off valves based on the system and intended use. It is also necessary to consider all laws and national, regional, provincial and municipal regulations of the country where the appliance is installed.

N.B.: the appliance can be installed with the expansion vessel closed because it is equipped with a device for stopping fuel loading, a safety manual reset thermostat, an audible alarm and SICURO top system, which are activated if the temperature becomes too high.

You can install the appliance in the same room as another boiler only if this has a sealed chamber; installation must be performed in compliance with the current regulations.

When connecting the appliance to the system, you should provide a zone that is always open (such as bathroom area) to enable the excess heat dissipation of the water in the body of the boiler.

The maximum mains water pressure should never exceed 2.5 bar; recommended operating pressure: 1.5 bar (during operation).

In the event of water with hardness exceeding 28 °f, an anti-limescale device must be installed. This must be selected on the basis of the specific properties of the water.

TO AVOID COMPROMISING THE FUNCTION AND LIFE OF THE HEAT PUMP, INSTALLATION OF A FILTER AND A MAGNETIC DIRT SEPARATOR IS REQUIRED DOWNSTREAM OF THE RETURN PIPE ON THE APPLIANCE.

The appliance must be mounted exclusively by qualified personnel. Scrupulously comply with the instructions given in this guide.

The manufacturer declines any liability for damages caused due to incorrect assembly.

THE DISPLAY

The appliance's operating mode is displayed on the console. After turning on the menu, it is possible to choose from many types of display and available settings according to the selected menu.

The figure below shows the display when the appliance (pellet side) is in ON mode.

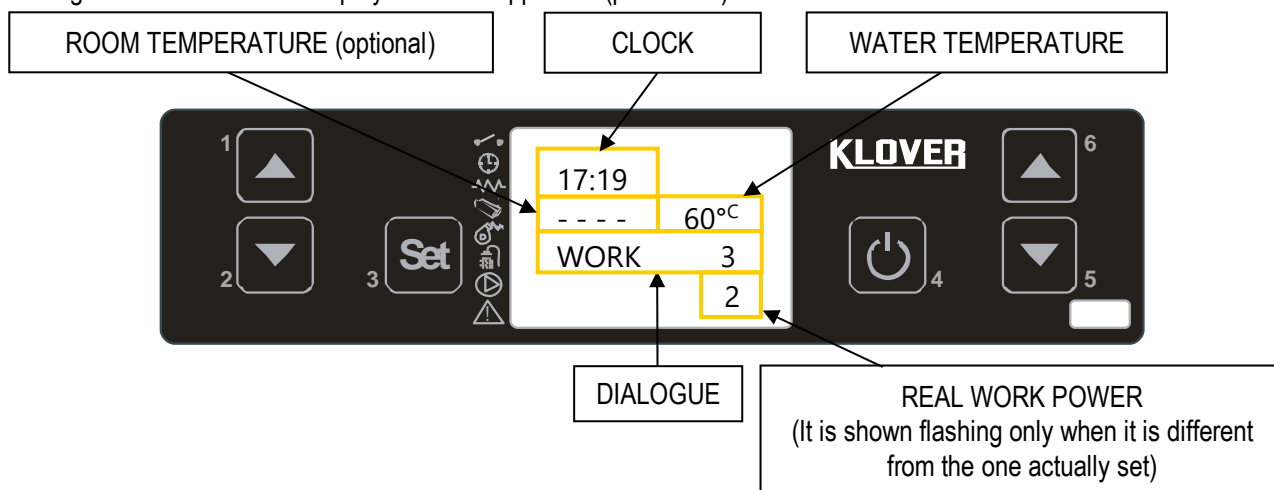

The figure below shows the display when the appliance (wood side) is in ON mode.

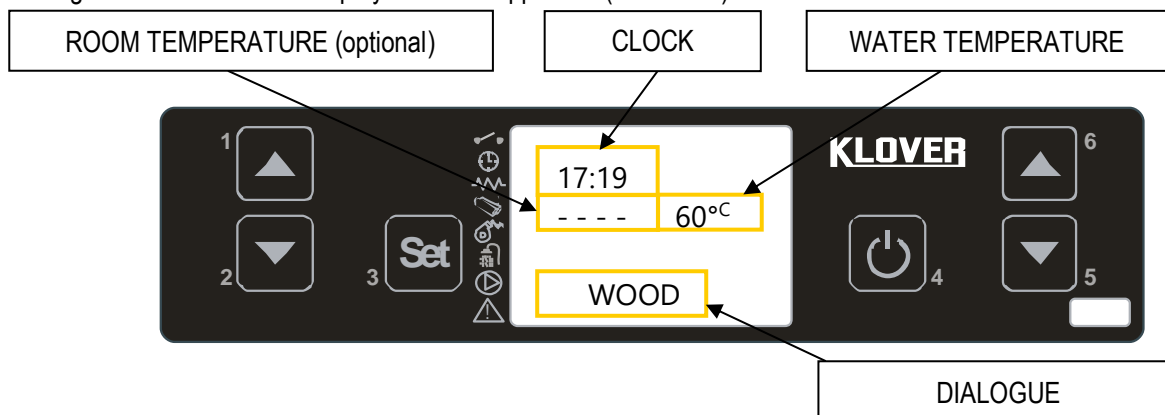

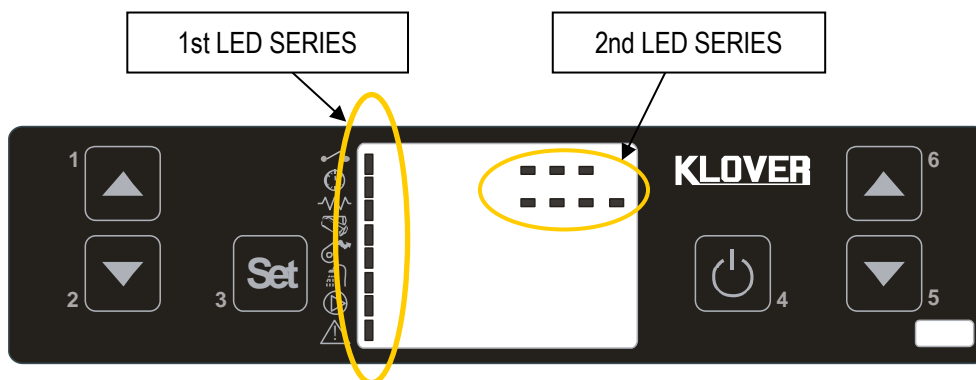

The following figure describes the meanings of the status signals appearing on the display left side (*1st LED SERIES*).



- ROOM THERMOSTAT: the LED is on when the thermostat contact is open.
- PROGRAMMABLE THERMOSTAT: the LED lights up when at least one start-up and switch-off program is active.
- IGNITION HEATING ELEMENT: the LED is on when the ignition heating element is active.
- SCREW FEED: the LED lights up when the pellet loading gear motor is started.
- FLUE GAS EXTRACTOR: the LED lights up when the flue gas extractor is active.
- DHW FLOW SWITCH: the LED lights up when the DHW flow switch contact is closed (which means there is demand for hot water). *LED only works when the flow switch is connected.*
- PUMP: the LED lights up when the system circulation pump is active.
- ALARM: the LED lights up when the boiler is in a state of alarm.

The meanings of the status signals appearing on the top right side of the display are described below (*2nd LED SERIES*).

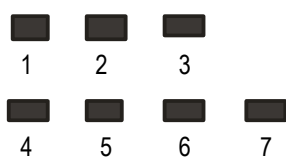

- LED 1: the LED lights up when the daily programme of the on off settings is active.
- LED 2: the LED lights up when the weekly programme of the on off settings is active.
- LED 3: the LED lights up when the weekend programme of the on off settings is active.
- LED 4: the LED lights up (flashing) when the operation parameters are being edited.
- LED 5: the LED lights up when the summer function is active (Not used on this product).
- LED 6: the LED lights up when the winter function is active.
- LED 7: the LED is not currently used.

The following diagram shows the display when setting or programming operating parameters.

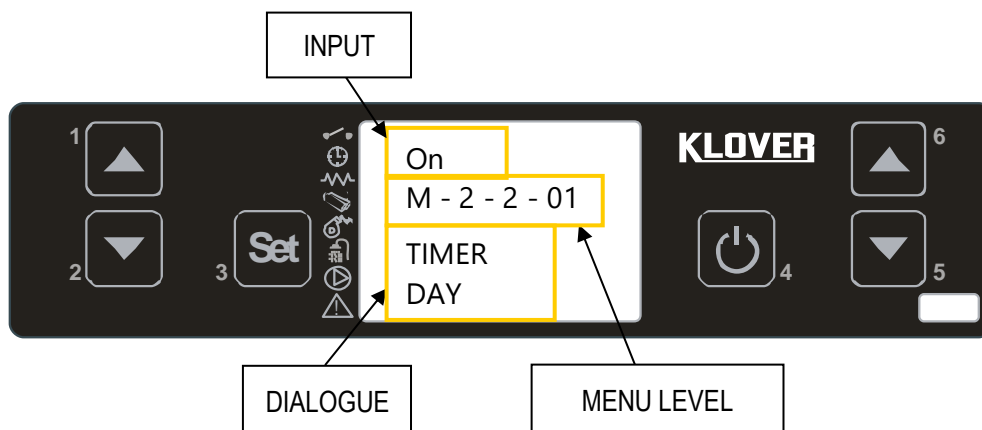

The INPUT area shows the entered programming values.
 The MENU LEVEL area shows the current parameter/menu level.
 The DIALOGUE area displays the meaning of the current parameter/menu.

The table explains how the buttons on the display work.

KEY	DESCRIPTION	MODE	ACTION
1	Increase temperature (1)	Programming mode..	Changes/increases the value of the selected menu item.
		Working/off..	Increases the DHW thermostat temperature value.
2	Decrease temperature (1)	Programming mode..	Changes/decreases the value of the selected menu item.
		Working/off..	Decreases the DHW thermostat temperature value.
3	Set	-	Enters the menu in question.
		Menu mode..	Accesses the next level of sub-menus.
4	ON/OFF Outlet	Working..	Switches the appliance on and/or off when pressed for 2 seconds.
		In alarm block..	Releases the alarm.
		Menu/programming mode..	Moves you to the previous menu level, saving the changes made.
5	Decrease power (2)	Working/off..	Decreases the working power of the appliance.
		Menu mode..	Moves you to the next menu item.
		Programming mode..	Moves you to the next submenu item, storing the changes made.
6	Increase power (2)	Working/off..	Increases the working power of the appliance.
		Menu mode..	Moves you to the previous menu item.
		Programming mode..	Moves you to the previous submenu item, storing the changes made.

(1) It selects the WATER TEMPERATURE SET "SET H2O" when first pressed.
 (2) It selects the WORKING OUTPUT "SET OUTPUT" when first pressed.

THE MENU

Access the Menu by pressing key 3 (Set).

The menu is divided into different items and levels, providing access to the programming and settings options of the appliance.

Buttons 5 and 6 allow you to select the menus to be modified.
Buttons 1 and 2 allow you to change the set value in the selected menu.

Listed below are the menus present on the PCB, with the relevant explanations.

Menu 01 – Set clock

Allows for setting the current date and time.

Menu 02 – Set timer

Sub-menu 02 – 01 – enable timer

Allows you to globally enable and disable all programmable thermostat functions. For the correct operation it is recommended to enable it (“ON”) when at least one on/off programme (daily, weekly or weekend programme) is activated.

MENU LEVEL	SELECTION	MEANING	POSSIBLE VALUES
02 – 01 – 01	ACTIVATE TIMER	Enable/disable set programs	ON – OFF

Submenu 02 – 02 – daily program

Allows you to enable, disable and set the programmable thermostat daily programme functions.

Two operating time slots can be set according to the following table, where OFF signals the clock to ignore the command:

MENU LEVEL	SELECTION	MEANING	POSSIBLE VALUES
02 – 02 – 01	DAILY TIMER	Enable/disable the daily programme	ON – OFF
02 – 02 – 02	START 1st DAY	Turn-on time of the first programme	Time – OFF
02 – 02 – 03	STOP 1st DAY	Turn-off time of the first programme	Time – OFF
02 – 02 – 04	START 2nd DAY	Turn-on time of the second programme	Time – OFF
02 – 02 – 05	STOP 2nd DAY	Turn-off time of the second programme	Time – OFF

Sub-menu 02 – 03 – weekly program

Allows you to enable, disable and set the programmable thermostat weekly program functions.

MENU LEVEL	SELECTION	MEANING	POSSIBLE VALUES
02 – 03 – 01	WEEK TIMER	Enable/disable the weekly programme	ON – OFF

The weekly programmer has 4 independent on/off programmes; it is not essential to use all four simultaneously. By setting OFF in the time field, the clock ignores the corresponding command.

PROGRAMME 1			
MENU LEVEL	SELECTION	MEANING	POSSIBLE VALUES
02 – 03 – 02	START PROG 1	Turn-on time of the first programme	Time – OFF
02 – 03 – 03	STOP PROG 1	Turn-off time of the first programme	Time – OFF
02 – 03 – 04	MONDAY PROG 1	Reference days of the first programme	On/off
02 – 03 – 05	TUESDAY PROG 1		On/off
02 – 03 – 06	WEDNESDAY PROG 1		On/off
02 – 03 – 07	THURSDAY PROG 1		On/off
02 – 03 – 08	FRIDAY PROG 1		On/off
02 – 03 – 09	SATURDAY PROG 1		On/off
02 – 03 – 10	SUNDAY PROG 1		On/off

PROGRAMME 2			
MENU LEVEL	SELECTION	MEANING	POSSIBLE VALUES
02 – 03 – 11	START PROG 2	Turn-on time of the second programme	Time – OFF
02 – 03 – 12	STOP PROG 2	Turn-off time of the second programme	Time – OFF
02 – 03 – 13	MONDAY PROG 2	Reference days of the second programme	On/off
02 – 03 – 14	TUESDAY PROG 2		On/off
02 – 03 – 15	WEDNESDAY PROG 2		On/off
02 – 03 – 16	THURSDAY PROG 2		On/off
02 – 03 – 17	FRIDAY PROG 2		On/off
02 – 03 – 18	SATURDAY PROG 2		On/off
02 – 03 – 19	SUNDAY PROG 2		On/off

PROGRAMME 3			
MENU LEVEL	SELECTION	MEANING	POSSIBLE VALUES
02 – 03 – 20	START PROG 3	Turn-on time of the third programme	Time – OFF
02 – 03 – 21	STOP PROG 3	Turn-off time of the third programme	Time – OFF
02 – 03 – 22	MONDAY PROG 3	Reference days of the third programme	On/off
02 – 03 – 23	TUESDAY PROG 3		On/off
02 – 03 – 24	WEDNESDAY PROG 3		On/off
02 – 03 – 25	THURSDAY PROG 3		On/off
02 – 03 – 26	FRIDAY PROG 3		On/off
02 – 03 – 27	SATURDAY PROG 3		On/off
02 – 03 – 28	SUNDAY PROG 3		On/off

PROGRAMME 4			
MENU LEVEL	SELECTION	MEANING	POSSIBLE VALUES
02 – 03 – 29	START PROG 4	Turn-on time of the fourth programme	Time – OFF
02 – 03 – 30	STOP PROG 4	Turn-off time of the fourth programme	Time – OFF
02 – 03 – 31	MONDAY PROG 4	Reference days of the fourth programme	On/off
02 – 03 – 32	TUESDAY PROG 4		On/off
02 – 03 – 33	WEDNESDAY PROG 4		On/off
02 – 03 – 34	THURSDAY PROG 4		On/off
02 – 03 – 35	FRIDAY PROG 4		On/off
02 – 03 – 36	SATURDAY PROG 4		On/off
02 – 03 – 37	SUNDAY PROG 4		On/off

Sub-menu 02 – 04 – week-end program

Enables/disables/sets the programmable timer’s weekend functions (Saturday and Sunday).

MENU LEVEL	SELECTION	MEANING	POSSIBLE VALUES
02 – 04 – 01	WEEKEND TIMER	Enable/disable the weekend programme	ON – OFF
02 – 04 – 02	START 1st WEEKEND	Turn-on time of the first programme	Time – OFF
02 – 04 – 03	STOP 1st WEEKEND	Turn-off time of the first programme	Time – OFF
02 – 04 – 04	START 2nd WEEKEND	Turn-on time of the second programme	Time – OFF
02 – 04 – 05	STOP 2nd WEEKEND	Turn-off time of the second programme	Time – OFF

TIP: in order to avoid confusion and any undesired switching on/off operations, only activate a single programme at a time (daily, weekly or weekend programme).

Deactivate the daily program if you wish to use the weekly program instead. If you use the weekly program in programs 1, 2, 3 and 4, always keep the week-end program disabled.

Only enable week-end programming after disabling the weekly program.

Menu 03 – Choose language

Allows you to select the dialogue language from the available choices (Italian, English, French, German and Spanish).

Menu 04 – Enable R.T. contact (only available if the remote control room thermostat sensor is enabled)

Enables operation of the Room Thermostat contact if the room temperature sensor on the “Remote control” is enabled (see the “Remote Control” manual).

The Room Thermostat contact operation is always active if the room sensor on the external “Remote control” is disabled.

For example:

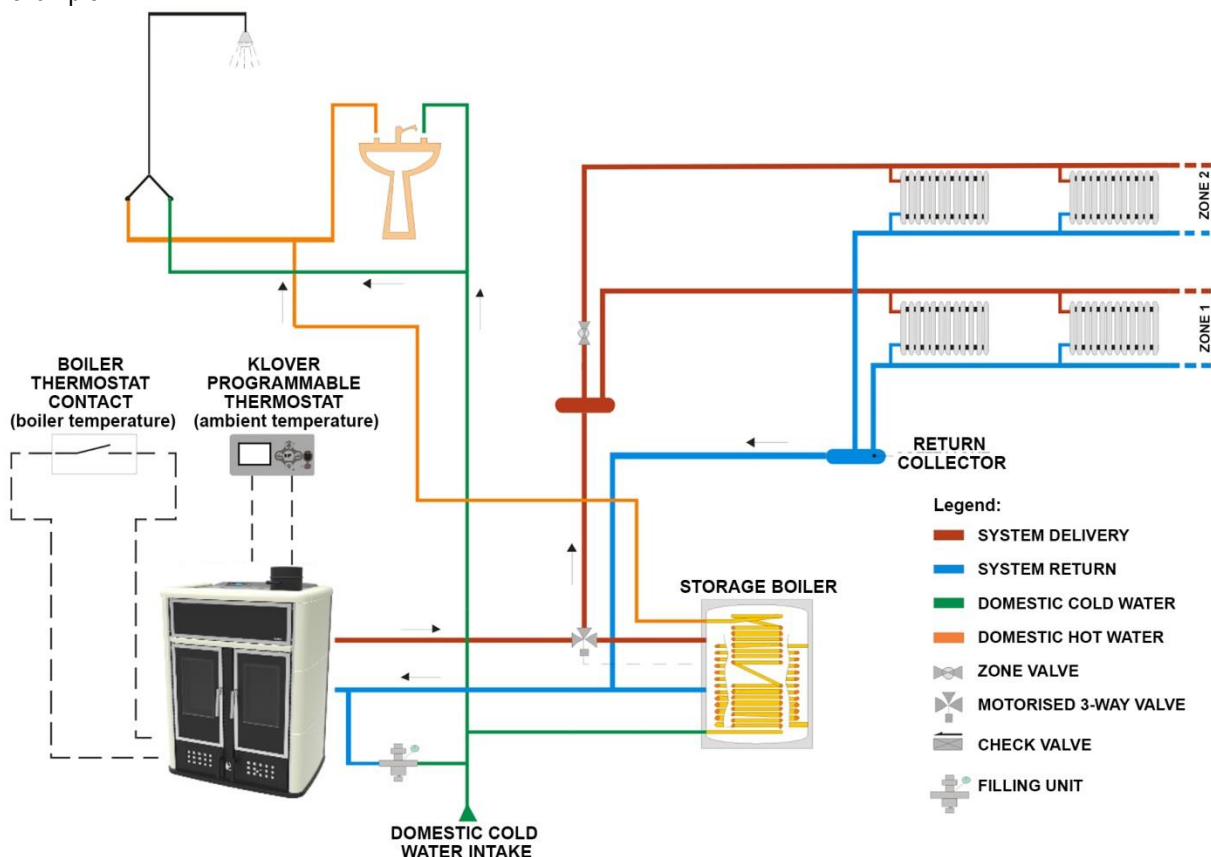

In this condition...

...to control the appliance with only the KLOVER "Remote control" room temperature sensor:

- enable the room sensor on the "Remote control" (Stove settings menu +> Enable room sensor -> ON)
- disable the boiler thermostat contact on the display of the appliance (Menu 4 - Enable contact -> OFF)

In this case, the appliance first enters economy mode operation, and then automatically switches off when the desired room temperature (detected with KLOVER "Remote control") is reached.

...to control the appliance with both the KLOVER "Remote control" room temperature and the boiler thermostat:

- enable the room sensor on the "Remote control" (Stove settings menu +> Enable room sensor -> ON)
- enable the boiler thermostat contact on the display of the appliance (Menu 4 - Enable contact -> ON)

In this case, the appliance first enters economy mode operation, and then automatically switches off when both temperatures have been reached.

...to control the appliance with the boiler temperature only:

- disable the room sensor on the "Remote control" (Stove settings menu +> Enable room sensor -> OFF). The room sensor is automatically disabled if no external "Remote control" is connected.
- enable or disable the boiler thermostat contact on the display of the appliance (Menu 4 - Enable contact -> ON/OFF).

In this case, the appliance first enters economy mode operation, and then automatically switches off when the boiler temperature (measured with an external thermostat immersed in the boiler) has been reached. This may be a viable solution to heat DHW in summer.

...to control the appliance without using external thermostats, but only with the water temperature in the heating system:

- disable the room sensor on the "Remote control" (Stove settings menu +> Enable room sensor -> OFF). The room sensor is automatically disabled if no external "Remote control" is connected.
- enable or disable the boiler thermostat contact on the display of the appliance (Menu 4 - Enable contact -> ON/OFF). The contact must obviously be bridged (already provided as standard).

Only when reaching the temperature set in "SET H2O" the appliance enters economy mode operation.

Summary:

CASE	REMOTE CONTROL ROOM SENSOR	MENU 04 – ENABLE R.T. CONTACT	ACTION
1	OFF	OFF	It works with room thermostat contact.
2	OFF	ON	It works with room thermostat contact.
3	ON	OFF	It works with remote control room sensor only.
4	ON	ON	It works with remote control room sensor and room thermostat contact.

Menu 05 – 3-Way Valve Threshold (can be used only on models with DHW)

It allows setting the temperature threshold for switching the 3-way motorised valve installed in the DHW system. Change-over occurs after 30" from reaching the set temperature and with a hysteresis of 2°C.

For example:

3-way Valve Threshold = 55°C

The valve opens after 30" from reaching 55°C.

The valve closes if 52°C is reached.

Menu 06 – Acoustic alarm

Allows you to enable or disable the acoustic signal in the event of an alarm. The alarm signal is only available on the appliance board, and not on the external "Remote control".

Menu 07 – Initial load

Enables pellet pre-loading for 90" when the appliance is switched off and cooled down. Start the function with button 1 and stop with button 4. This may be useful if the appliance is switched on after the tank has been completely emptied, or when it is filled for the first time. **Warning: once the operation has been completed, before switching on the appliance you should empty the accumulation of pellets deposited inside the brazier.**

Menu 08 – Fireplace status

It allows for viewing the instantaneous state of the appliance, by showing the state of the various devices connected to it. Several pages are displayed in succession. The data is reserved for Technical assistance Centre.

Menu 09 – Technical calibration

Allows you to access all data reserved for the Technical Assistance Centre. Access is protected by a password. Unauthorised access can cause serious damage to the equipment, to things and the environment as well as personal injuries.

Menu 10 – Pellet mode

Allows you to enable/disable the automatic switch on the pellet side, when the wood side turns off.

When Menu 10 = ON the pellet side:

- turns on automatically when the wood side turns off;
- is switched on manually;
- turns on with the integrated timer.

When Menu 10 = OFF the pellet side:

- does not turn on automatically when the wood side turns off;
- can not be switched on manually;
- if pellet mode is operating, and then the pellet side is switched off, it remains off;
- turns on with the integrated timer.

INITIAL START-UP

Filling the boiler unit and the system for the first time

After connecting the appliance to the water system, fill the boiler unit as follows:

- Dilute the *Long Life* product to 2% by pouring the contents of the bottle directly into the boiler unit (See section "*Maintenance of the boiler unit*");
- Open the "*Boiler unit loading cock*" to fill the entire boiler unit until the water reaches the level of the "*Boiling discharge pipe*".

N.B.: the water level inside the boiler unit should cover the exchangers (primary and/or secondary).

Regularly check that the water in the boiler unit is at the level of the "boiling discharge pipe" at 80 ° c. top up as necessary.

The appliance is fitted with a water level sensor which signals when there is insufficient water in the boiler unit. If the level is too low, the "WATER MISSING" message will appear on the display followed by an audible alarm (if enabled from "Menu 06"); if this happens, fill to the appropriate level by opening the "*Boiler unit loading cock*" and fill the boiler unit until the water level reaches the "*Boiling discharge pipe*";

After filling the boiler unit, fill the system as follows:

- Check the seal of all piping, the expansion vessel, and the circulation pump;
- Open the "*automatic air release valve*" on the appliance;
- Open the "*and system load cock*" to fill the system. Gradually allow the air to come out from the appliance through the "*automatic air release valve*"; **optimum working pressure is 1.5 bar (when the appliance is operating);**
- Vent all radiators and any other de-aeration systems to ensure that there are no air bubbles in the system.

After installation, check the seal of all plumbing joints for the first few days of operation.

The system and the water inside the boiler unit can be emptied by opening the “*boiler unit drain cock*” situated at the back of the appliance.

In a system subject to being emptied frequently, it is essential that filling is performed with water suitably treated to remove hardness which can give rise to scaling.

NEVER OPERATE THE APPLIANCE WITHOUT WATER IN THE BOILER UNIT. IN ADDITION TO NOT HEATING, IT MAY ALSO COMPROMISE THE OPERATION AND LIFE OF THE APPLIANCE.

Antifreeze protection

In intensely cold periods it is good practice to leave the heating system running. In the event of a prolonged absence, antifreeze must be added to the heating water and to the water in the boiler unit. **For the choice of antifreeze and the quantity to add to the boiler unit, see section “Maintenance of the boiler unit” in order to avoid compromising the operation and life of the product.**

The emptying of the heating system should also be considered. If it is being emptied frequently, it is essential that filling is performed with water suitably treated to remove hardness which can give rise to scaling.

The boiler unit should always have treated water (see section “Maintenance of the boiler unit”); never leave it without water, in order to avoid rusting which would affect its life.

Operating principle

The appliance can operate using only the pellet side, only the wood side or with both the combustion chambers in operation.

The operation of the pellet side is related to the settings of “Menu 10 – Pellet mode” (see section “The menu”)

The following specifications will provide useful information about the operation of the appliance in the different conditions:

- **Pellet operation**

- The appliance will operate only with pellets;
- If the wood side is operating, the pellet side turns off when the temperature set on Set H2O is reached.
- If the wood side is off, the pellet side enters economy mode “H2O ECONOMY” when the “SET H2O” is reached.

- **Wood operation**

- The appliance will operate only with wood;
- If the wood side is operating, you can turn on manually the pellet side, which will though turn off when the Set H2O temperature is reached;
- With “Menu 10 = ON”: The pellet side automatically **switches on** when the wood side turns off.
- With “Menu 10 = OFF”: The pellet side **will NOT switch on** automatically when the wood side turns off.

- **Operation with room thermostat**

The appliance can be controlled using the room thermostat only on the pellet side (controlled combustion). If the wood side is operating, the room thermostat is disabled (see section “Connection to the room thermostat”).

Ignition (WOOD SIDE)

Perform the following operations:

- Connect the appliance to the electrical system by using the provided cable;
- Set the “power ON/OFF switch” on the rear side of the appliance to “1” (on);

- **Make sure that there is water in the system and the boiler unit;**
- Open the *“upper smoke damper”* on the flue inlet by setting the handle to the vertical position;
- Open the *“primary manual air combustion damper”* by turning the knob fully to the right.
- Open the *“secondary automatic air combustion damper”* by turning the knob fully anti-clockwise.
- Light the fire using seasoned, thin wood;
- When the wood has ignited well, close the *“primary manual air combustion damper”* by turning the knob fully to the left and adjust the combustion air via the *“secondary automatic air combustion damper”*, by adjusting the opening of the relative knob;
- If necessary, adjust the draught in the flue by adjusting the *“upper smoke damper”* on the flue inlet.

During ignition, combustion may be difficult to achieve, until the flue gas pipes and the flue are hot. Weather conditions may also affect the way the flue draws.

The fire door must be kept closed at all times except during refuelling in order to prevent the escape of smoke.

Never light the appliance with alcohol or other highly flammable liquids.

The fire door has an opening for the flow of post-combustion air between the glass and the frame. This opening does not assure a seal in the combustion chamber. Any smoke escaping during ignition and/or normal operation of the appliance is not a defect, but is related to poor draught in the flue, a lack of air vents in the room or the type/quality of wood burned.

Always remember to open the smoke damper a few seconds before loading the combustion chamber with new wood in order to prevent the backflow of smoke into the room.

ATTENTION!!!

IN ORDER FOR THE APPLIANCE TO OPERATE PROPERLY THE CAST IRON BRAZIER INSIDE THE COMBUSTION CHAMBER MUST BE POSITIONED AS SHOWN BELOW , TAKING CARE NOT TO INVERT IT, TO PREVENT THE ASH FROM COMPACTING AND NOT FALLING INTO THE ASH DRAWER. IF THE CAST IRON BRAZIER IS NOT TURNED PROPERLY, THIS WOULD AFFECT ITS LIFESPAN.



Warning: during the ignition phase and normal operation of the appliance, maintain the necessary safety distance and do not stand in front of it.

Boiling

If for any reason (power cut, a pump fault, too much wood, etc...), the water in the appliance reaches boiling point, carry out the following operations immediately:

- Open a hot water tap and leave the water to run until the temperature in the appliance drops (on prepared models only);
- Fully close the “secondary automatic air combustion damper” by turning the knob fully clockwise.
- Fully open the “upper smoke damper” on the flue inlet by setting the handle to the vertical position;

After ascertaining the reason for the high temperature, wait for everything to go back to normal (temperature below 60°C).

After boiling, it is necessary to reset the safety thermostat situated at the back of the appliance.

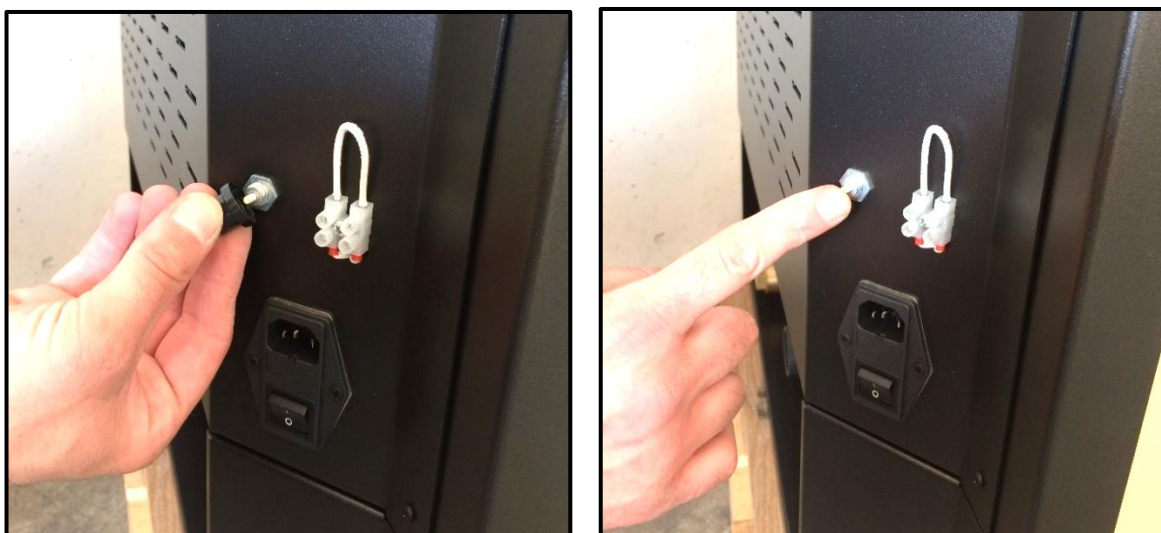

Unscrew the black cap on the appliance and press the button under the cap. You can now turn the appliance on again.

Ignition (PELLET SIDE)

Perform the following operations:

- Connect the appliance to the electrical system by using the provided cable;
- Set the “power ON/OFF switch” on the rear side of the appliance to “I” (on);
- Fill the pellet tank; for the first ignition we recommend that you follow the instructions in the “Menu 07 – INITIAL LOAD” to avoid wasting the time required to fill the entire screw feed channel **(this should be done every time the appliance runs out of pellets)**;
- Set the “Menu 10 – PELLET MODE” to “ON”.
- Switch the appliance on by using the ignition button on the display (button 4). See the instructions below. **Before switching on the device make sure that there are no pellets in the brazier; otherwise it is necessary to empty and clean the brazier.**

ATTENTION: IN ORDER NOT TO COMPROMISE SAFETY AND THE CORRECT OPERATION OF THE APPLIANCE, DO NOT LOAD PELLETS MANUALLY INTO THE BRAZIER.

We recommend that you use high quality pellets so as not to impair the operation of the appliance. Damage caused by poor-quality pellets shall not be covered by the warranty.

After a few seconds from the ignition, the display shows “**START**”, and the flue gas intake device and ignition resistance switches on. After a few seconds the appliance goes into a phase of preheating “**WAITING PREHEATING**” useful to sufficiently heat the ignition plug before the loading of the pellets in the brazier. After the pre-loading phase the appliance switches to the “**WAITING FLAME**” phase where the pellets are loaded into the brazier at regular intervals. When the flame is lit, the display shows the message “**FIRE**”. This step is used to allow the fire to spread evenly across the brazier and burn all the unburned pellets from the previous phases. After these phases, the appliance enters the work mode at the pre-set power value.

If the ignition fails, the display will show the alarm “**NO IGNITION**”.

The alarm may also occur if the brazier is dirty; in this case, clean the brazier and re-start.

Summary:

The ignition cycle can last 25/30 minutes maximum and is divided into five steps:

- Step 1 - START = Ignition of the flue gas extractor.
- Step 2 - WAITING PREHEATING = Waiting for the resistance preheating.
- Step 3 - PELLET P-LOAD = Pellet pre-load (initial continuous load) and resistance ignition.
- Step 4 - WAITING FLAME = Loading pellets (intermittent load) and resistance operating.
- Step 5 - FIRE = Resistance switch-off and flame stabilisation.

The appliance switches into working mode after ignition phase at the power output set during ignition via buttons 1 and 2.

Warning: during the ignition phase and normal operation of the appliance, maintain the necessary safety distance and do not stand in front of it.

Working mode from Power 1 to Power 5 (PELLET SIDE)

The operating powers from power 1 to power 5 are as follows.

During the working phase, by pressing the buttons 1 or 2, you can set the “SET H2O” (maximum water temperature in the boiler). When this temperature is reached, the appliance enters economy mode operation “T-H2O ECONOMY”. 5°C before reaching the temperature set on “SET H2O”, the appliance starts modulating output by decreasing the pellet intake and reducing the flue gas extraction speed.

For example: “SET H2O” set at 75 °C
Working power set at 5

- Working power automatically changes to 4 when the temperature reaches 71°C.
- Working power automatically changes to 3 when the temperature reaches 72°C.
- Working power automatically changes to 2 when the temperature reaches 73°C.
- Working power automatically changes to 1 when the temperature reaches 74°C.
- Working power automatically changes to economy mode operation “T-H2O ECONOMY” when the temperature reaches 75°C.

The appliance will now automatically switch itself off if at least one of the following conditions occurs:

- If it remains in Economy mode Operation “T-H2O ECONOMY” for a time set on Pr44 (30 minutes as default setting).
- If it exceeds the temperature differential set on Pr43 (set as default at 5°C), in other words if **Temperature H2O > (“SET H2O” + Pr43)**.

The appliance automatically starts up again if the following condition occurs:

- The temperature falls below the temperature differential set on Pr43 (5°C as default setting) or H2O Temperature < (“SET H2O” – Pr43).

If the above condition occurs when the switch-off cycle is not yet completed, please wait until the cycle is complete.

The cleaning cycle of the brazier (displayed under “BRAZIER CLEANING”) is done at predetermined time intervals for an established period (see “PCB parameters”).

Switch-off cycle (PELLET SIDE)

By holding down button 4 (ON/OFF) the appliance switches itself off. The display will show “FINAL CLEANING”. The pellet loading stops and the flue gas extractor speed increases to maximum and then switches off after the cooling of the appliance, displaying “OFF”.

Working mode at DHW output (on prepared models only)

The DHW output operating power is as follows.

Domestic hot water is produced instantly via a heat exchanger immersed in the water inside the appliance. To obtain sufficient amounts of hot water, the appliance must have a minimum temperature of 65°C.

If a lot of hot water is needed, manually set the appliance to “DHW” (see section “Modifying the working power”). The purpose of the “DHW” is to postpone operation of the heating pump to higher temperatures, so that all heat is used for hot water. Hence, the circulating pump in the heating system is off during this phase. When the hot domestic water is no longer needed, you must set the appliance back to one of the five working powers (“1”, “2”, “3”, “4” and “5”).

The appliance is furthermore fitted for the electric connection of a flow switch on the DHW system; the latter enables the automatic passage to “DHW” if there is a request for hot domestic water. Contact the Authorised Technical Assistance Centre for the electrical connection of the flow switch.

If water is particularly hard, it is essential to install an anti limescale device at the DHW exchanger inlet, to be chosen according to the water type.

If there is a drop in the quantity or the temperature of hot water, the heat exchanger may need to be cleaned (chemically) by the installer.

Modifying the working power

To modify the working power you must select “SET POWER” by pressing buttons 5 or 6. During this operation, the display will appear as in the following picture.



You can set one of the 5 working powers (“1”, “2”, “3”, “4” and “5”) (see “Working mode from power 1 to power 5”) or the domestic hot water power (“DHW”) (see “Work mode at domestic hot water power”).

After setting the desired value, press button 4 or wait a few seconds to confirm.

Change the water temperature of the heating system

To modify the water temperature you must select “SET H2O” by pressing buttons 1 or 2. During this operation, the display will appear as in the following picture.



After setting the desired value, press button 4 or wait a few seconds to confirm.

During the working mode the pellet side enters “Economy mode operation” when that temperature value is reached (see “Working mode from Power 1 to Power 5”).

Remote control



The following table shows the function of each button on the remote control:

Button 1 - Increase temperature.

Button 2 - Decrease temperature.

Button 3 - Switch on/off.

Button 4 - Jolly (can be matched to a function depending on the firmware).

Button 5 - Decrease power.

Button 6 - Increase power.

Battery: dc 3v

Model: CR2025 (provided)

Battery life depends on its storage times. If the battery is flat, it can not be considered as a manufacturing fault.

PROBLEMS, ALARMS, USEFUL ADVICES

Useful info...

Listed below is some important information regarding the appliance:

- It is normal for the appliance to emit a smell of paint during its first few days of operation. We recommend ventilating the installation room during the initial start-up. For the first few days of operation we also recommend that you set the appliance to near-maximum level.
- The boiler unit is treated with anti-oxidant paint in order to protect it against oxidation in the event of long periods of inactivity. After initial start-up, this paint no longer preserves its original features and any wear of the paint inside the combustion chamber should not be regarded as a manufacturing fault.
- Do not clean with water inside the combustion chamber; any oxidation of the combustion chamber after a long period of inactivity is not to be considered as a manufacturing fault.
- Any perceived noise during operation may be caused by the expansion settling of the plates that make up the boiler unit. These noises are accentuated especially during ignition and switching off phases of the appliance and are not to be considered a manufacturing fault.
- **If ignition fails, empty the pellets out of the brazier; only then can you reignite the appliance in order to avoid gasification and consequent "explosion" during ignition which could lead to the breakage of the door glass.**
- The door of the appliance does not provide airtight closing (opening for secondary-post combustion air passage); any perceived smoke smell (especially during ignition) is not to be considered a manufacturing fault.
- The appliance works exclusively with wood logs and/or wood pellets; do not burn different fuels.
- The appliance can work only if connected to the heating system and with water inside the boiler unit. Do not start the appliance for any reason if a plumbing connection in compliance with current regulations has not been done and if you have not filled the entire boiler unit and system with water in order not to compromise its life.
- The noise level of the appliance is emphasised if the pellet container is empty. Therefore we recommend that you always keep the pellet level to at least half tank.
- If there is soot and fine particulate in the room where the appliance is installed, check the seal on the flue gas pipes and the filter of the ash vacuum device used for cleaning.
- Clean the boiler unit regularly (at least every 2 years) by changing the water inside and removing any solid residues. Next, fill the boiler unit with fresh water to restore the right dilution of LONG LIFE. Do not leave the boiler unit without any water, to avoid rusting which would reduce its lifespan.

What happens if...

...the pellets do not ignite

If the ignition fails, the display will show the alarm message “NO IGNITION”.

Cancel the alarm and reset the appliance to standard condition by pressing button 4 for a few seconds.

If ignition fails, empty the pellets out of the brazier; only then can you reignite the appliance in order to avoid gasification and consequent “explosion” during ignition which could lead to the breakage of the door glass.

...the fire door on the pellet side is open or not properly closed

If the door is left open or not properly closed, the pellet loading will not start, therefore the appliance will not switch itself on. If the door is opened during normal operation, the appliance switches to “THERMAL SAFETY” alarm.

...the flue pipe is dirty, blocked or not correctly installed

If the flue is dirty, blocked or incorrectly manufactured, pellet loading will not start, thus the appliance will not switch itself on. If the flue is obstructed during normal operation, the appliance switches to “DEPRESS.-FAILURE” alarm.

...the appliance is overheated

If the water in the boiler body is overheated (>94 °C), the pellet will not be loaded because the manual reset thermostat cuts in. If this happens during normal operation, the appliance switches to “THERMAL SAFETY” alarm. It is therefore necessary to reset the “manual reset thermostat” (see “Boiling”) before switching the appliance on again. To reset, it is necessary to remove the black cap and press the button below.

...lack of power (blackout)

If a power blackout occurs for a shorter time than Pr48, when power is restored, the appliance will immediately re-start in the working mode (recovering the set working power).

If the outage lasts longer than Pr48, when power is restored, the appliance will enter the “STOP FIRE” (stand-by) mode running the entire switch-off cycle until cooling. When this phase is over, the appliance can be restarted resuming work at the set power.

Previous state	Black-out duration	State after power restore
OFF	any	OFF
START	Duration < Pr48	START for 180 seconds
START	Duration > Pr48	START for 180 seconds
WAITING PREHEATING-P-LOAD PELLETS	any	START for 180 seconds, then WAITING PREHEATING
FLAME STAND-BY	any	BLACK OUT ALARM
FIRE PRESENT	Duration < Pr48	FIRE PRESENT
FIRE PRESENT	Duration > Pr48	STOP FIRE with automatic re-ignition after machine cooling
WORK (any phase)	Duration < Pr48	WORK (any phase)
WORK (any phase)	Duration > Pr48	STOP FIRE with automatic re-ignition after machine cooling
BRAZIER CLEANING	Duration < Pr48	BRAZIER CLEANING
BRAZIER CLEANING	Duration > Pr48	STOP FIRE with automatic re-ignition after machine cooling
FINAL CLEANING	any	FINAL CLEANING and after cooling → OFF
STOP FIRE	any	STOP FIRE

Attention: if the battery of the clock runs out or it is not inserted properly (see “Wiring diagram”), we do not guarantee that the appliance will function properly after the black-out.

Alarm signals

The following table describes the different alarms which may appear.

DISPLAY VISUALISATION	ORIGIN OF ALARM
AL 1 - BLACK OUT ACTIVE ALARM	Black-out alarm. When power is cut off under determined conditions (see "What happens if...")
AL 2 - FLUE GAS PROBE ACTIVE ALARM	Faulty or disconnected flue gas temperature sensor.
AL 3 - HOT TEMP ACTIVE ALARM	Flue gas over-temperature. When flue gas temperature is higher than 260°C. Before displaying the alarm, or when flue gas maximum temperature is reached (Pr14), the display shows "HOT FLUE GAS".
AL 4 - EXTRACTOR-FAILURE ACTIVE ALARM	Faulty flue gas extractor. When the encoder (tachometer) in the extractor detects an extractor speed equal to 0.
AL 5 - NO IGNITION ACTIVE ALARM	No ignition. When the flue gas minimum temperature (Pr13) is not reached within the maximum ignition cycle time (Pr01).
AL 6 - NO PELLETS ACTIVE ALARM	Sudden shut-down during the work phase. When, during the work phase, the flue gas temperature drops below the minimum threshold (Pr28).
AL 7 - THERMAL-SAFETY ACTIVE ALARM	Temperature safety device. When the safety thermostat (water over temperature) or fire door micro switch (contact interrupted) cuts in. If the safety thermostat cuts in the boiler stove must be manually rearmed.
AL 8 - DEPRESS.-FAILURE ACTIVE ALARM	Poor depression. When the flue gas pressure switch cuts in (contact interrupted) due to poor draught in the flue pipe.
AL 9 - WATER PROBE ACTIVE ALARM	Faulty or disconnected water temperature probe.
AL c - SF TRIAC ERROR ACTIVE ALARM	Screw feed TRIAC error. When the screw feed gear motor does not stop for at least 0.2 seconds during the maximum work interval of 8.0 seconds. Before the alarm is activated a safety relay cuts in and forcibly cuts off the power supply to the gear motor.

Every alarm causes the appliance to switch-off immediately. The alarm state is reached after the time set on Pr11 (set as default at 20") and it can be reset by pressing button 4 for a while.

CLEANING AND MAINTENANCE

Precautions before cleaning

Before carrying out any cleaning or maintenance operations, make sure that:

- the appliance is off and has cooled down completely;
- the ash is completely cold.
- the ash vacuum device used for cleaning is suitable and its filter is in good condition.

Before re-starting the appliance, re-install all previously removed components.

During cleaning operations, use the personal protection devices specified in Directive 89/391/EEC.

The frequency for cleaning depends on the type and quality of pellet and wood used; therefore, the indicated times may change.

Any problem affecting the appliance caused by lack of cleaning will not be covered by the warranty. The failure of these operations could affect the safety of the product.

Ordinary cleaning (PELLET SIDE)

The ordinary cleaning of the appliance must be done at least every 20 hours of operation or after 3-4 ignition cycles, so as to always guarantee efficient performance and optimal operation. Please proceed as follows:

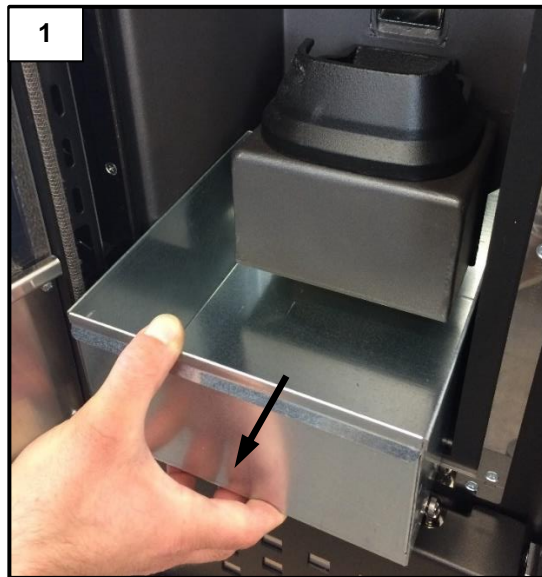

Empty the ash drawer (Figure 1).



Thoroughly clean the brazier from combustion residues by taking it out from its position and removing any residues inside (Figure 2). Use a suitable ash vacuum device to remove any ash deposited under the brazier (Figure 3).
When finished, put the brazier back in its place.



Press repeatedly the left side scraper (from bottom to top and vice versa for the entire length of the rod) to allow cleaning of the side flue gas pass (Figure 4).

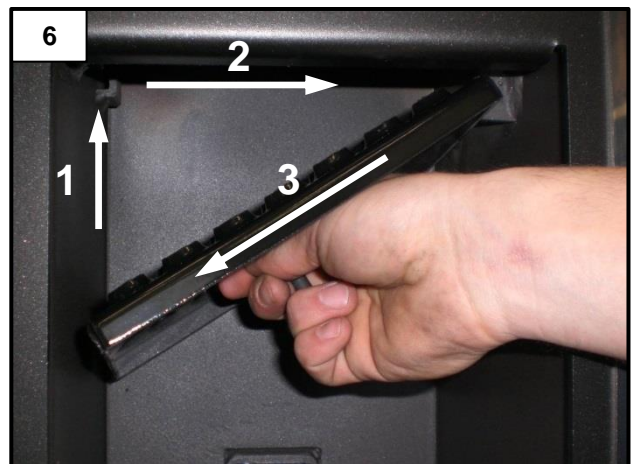
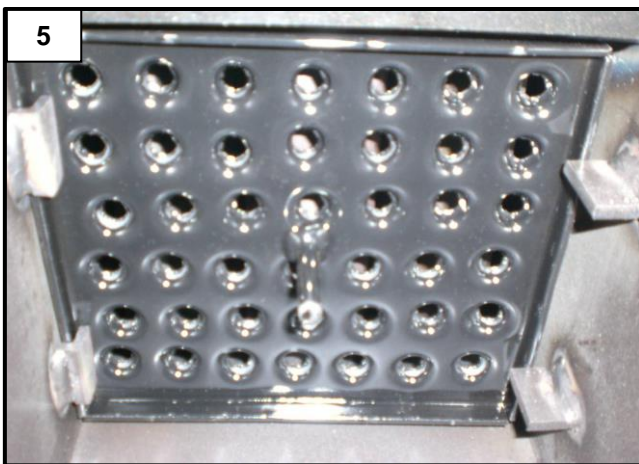

Remove the flame arrester inside the combustion chamber (Figures 5 and 6).



Scrape the flame arrester and remove any obstructions from the holes (Figure 7).

To remove any deposits, it is also recommended that you scrape the inner walls of the combustion chamber with a spatula. Do not use tools that can reduce the thickness of the metal sheet of the boiler unit.

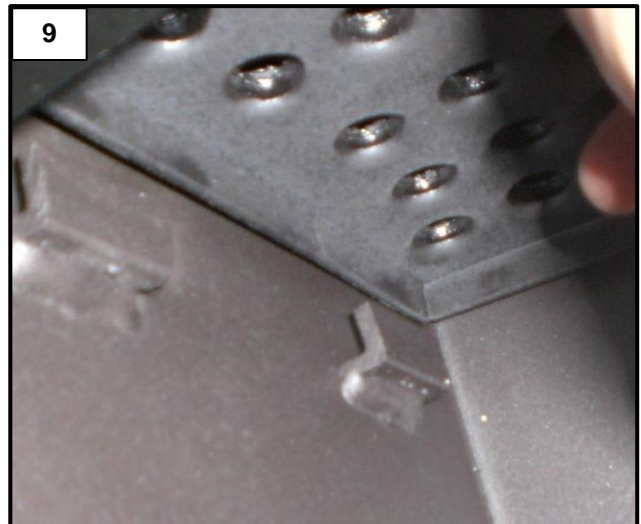

Put the flame arrester back making sure to hook it to the two flaps inside the combustion chamber (Figures 8 and 9).

WARNING: use suitable ash vacuum devices equipped with a fine mesh filter in order to prevent ash from being blown into the room and to prevent damaging the vacuum cleaner. We do not recommend the use of normal vacuum cleaners.

Ordinary cleaning (WOOD SIDE)

Too much combustion residue inside the ash drawer prevents the proper supply of oxygen for combustion, reducing the performance of the appliance, as well as possibly damaging the cast iron brazier inside the combustion chamber.



We recommend you periodically empty the ash drawer (figure 10) to ensure an efficient flow of combustion air at all times. It is also recommended to occasionally remove residual ash from the combustion chamber.

Extraordinary cleaning (PELLET SIDE)

The extraordinary cleaning of the pellet side of the appliance must be done at least every 15 days so as to always guarantee efficient performance and optimal operation. Please proceed as follows:

Carry out the ordinary cleaning of the pellet side;



After removing the ash drawer pull out the bottom under it (Figure 11) and vacuum the deposits on the inside using a suitable ash vacuum device (Figure 12). When finished, replace the bottom and the ash drawer.

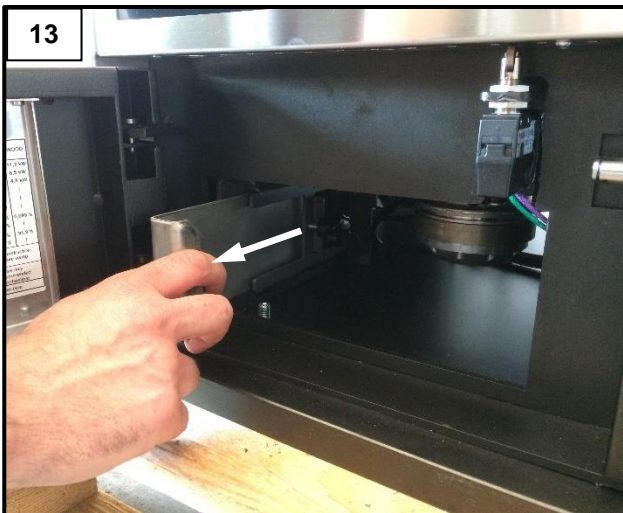

After unscrewing the hand-wheel, extract the left side flue gas pass inspection vent (Figure 13). Remove the deposits inside using a suitable ash vacuum device (Figure 14). When finished, close the pipe making sure that you have secured the inspection opening.

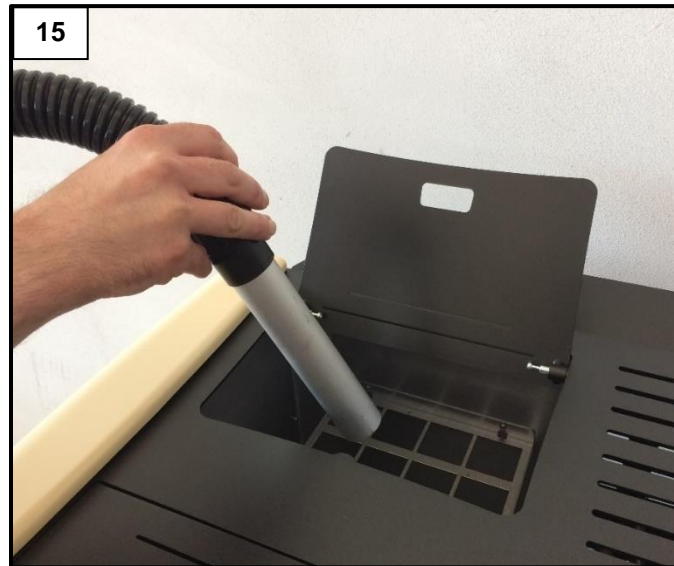

To ensure correct operation, it is necessary to remove the sawdust deposited on the base of the tank (Figure 15) at least once every 15 days. **The pellet tank must be emptied at the end of every season.**

Extraordinary cleaning (WOOD SIDE)

The extraordinary cleaning of wood side of the appliance must be done at least every 15 days so as to always guarantee efficient performance and optimal operation. Please proceed as follows:

Carry out the ordinary cleaning of the wood side;



Clean the elements on top of the combustion chamber using the supplied brush and passing it repeatedly between one and the other element (Figure 16).

To remove any deposits, it is also recommended that you scrape the inner walls of the combustion chamber with a spatula. Do not use tools that can reduce the thickness of the metal sheet of the boiler unit.

Annual cleaning

The annual cleaning of the appliance must be done at least once a year so as to always guarantee efficient performance and optimal operation. Please proceed as follows:

Carry out the routine and extraordinary cleaning;



Undo the 2 screws which hold the bottom left angular element (Figure 17) and remove the inspection cap of the stainless steel t-shaped fitting by unscrewing the provided hand-wheel (Figure 18).



Carefully clean all the stainless steel pipe on the back of the appliance with the brush provided (Figure 19). Put back the stainless steel inspection cap of the t-shaped fitting, making sure it has been securely fastened.



After opening the pellet side fire door, undo the two screws (Figure 20) and remove the front left profile (Figure 21).



Remove frontally the three left sides (Figure 22).

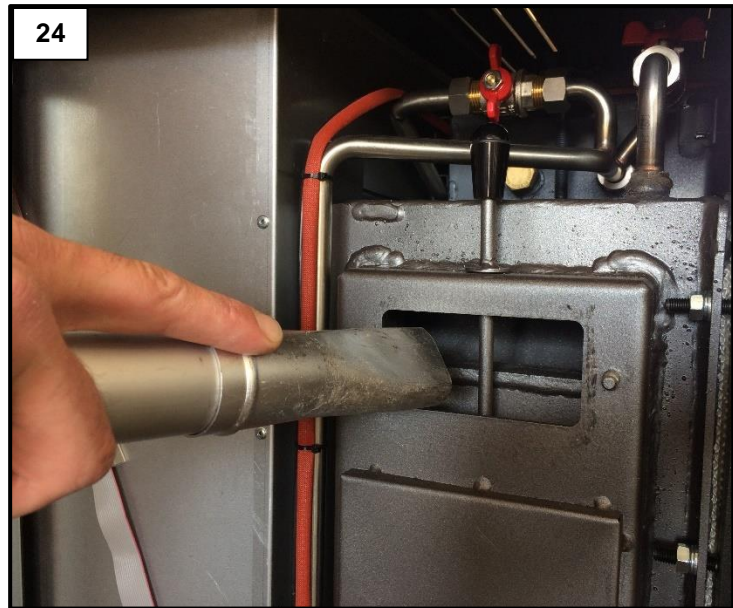

After unscrewing the two bolts, remove the left side flue gas pass inspection vent (Figure 23). Clean any obstructions affecting the flue gas side passage (Figure 24). When finished, refit the inspection vent making sure it has been securely fastened.

Cleaning the ceramic glass

Always clean the glass when the appliance is off and has cooled down completely. Use a damp cloth or a detergent specifically formulated for ceramic glass. Do not use abrasive sponges. Do not clean the glass if still warm; changes in temperature can lead to breakage.

Cleaning the flue

The flue must be cleaned at least once a year, at the beginning of winter, and whenever it becomes necessary. It is important to check for any obstructions in the flue before switching the appliance on following long periods of inactivity. If the flue is not cleaned, the operation of the appliance and its components may be compromised.

The cleaning frequency of the appliance and flue depends on the quality of the pellets used.

USE TOP QUALITY PELLETS OR WOOD TO OBTAIN THE BEST RESULTS.

Maintenance

Timely and systematic maintenance is essential for guaranteeing correct operation, optimal heat performance and durability of the device. Therefore, qualified staff should check the appliance at least once a year at the beginning of the season.

You must periodically check the seals because the latter guarantee the air- and water-tightness of the appliance and its good functioning; if they are worn or damaged you need to be replaced immediately by contacting a **Klover Authorised technical assistance centre**.

For proper operation, the appliance must undergo routine maintenance performed by a Klover Authorised technical assistance centre at least once a year.

Maintenance of the boiler unit

The appliance is supplied with a special additive call LONG LIFE, designed to protect the boiler unit and heat exchangers from rust and to keep the water inside the boiler unit clean. LONG LIFE should be diluted to 2% with water inside the boiler unit. It can be poured directly into the boiler unit before or after filling it with water.



For ease of use, a table is provided of the annual dilution dosages of LONG LIFE:

Boiler unit water capacity	Recommended dose of LONG LIFE (2%)	Recommended dose of LONG LIFE (1%) after the first year	Recommended Recommended LONG LIFE (2%) after the second year
50 l	1000 ml	500 ml	Empty and clean the entire boiler unit. Restore the water level, adding 1000 ml of LONG LIFE

It is recommended to empty the boiler unit water every 2 years and remove any solid residues caked on the bottom. These residues reduce the effectiveness of LONG LIFE. The boiler unit should then be refilled and the optimum dosage of LONG LIFE should be added. If too much LONG LIFE is added by accident, empty and refill the boiler unit. Observance of the proper frequency for cleaning the boiler unit will prolong its life and is essential for the validity of the warranty.

ATTENTION!!! NON-USE AND OR AN INCORRECT DOSAGE OF LONG LIFE WILL INVALIDATE THE WARRANTY ON THE BOILER UNIT.

LONG LIFE has been designed and tested on SICURO TOP products; KLOVER declines all liability arising from the use of LONG LIFE in products or applications other than those indicated.

Contact your agent/retailer to purchase LONG LIFE.

Below are a number of special warnings for the use of LONG LIFE:

- Causes serious eye irritation.
- May cause an allergic skin reaction.
- Harmful to aquatic organisms with long-term effects.
- Avoid breathing dust/fumes/gases/fog/vapour/aerosols.
- Wear gloves/protective clothing/protect the eyes/face.
- Do not dispose of in the environment.
- IN CASE OF CONTACT WITH EYES: rinse thoroughly for several minutes. Remove contact lenses if it is easy to do so. Continue rinsing.
- IN CASE OF IRRITATION OR SKIN RASH: consult a doctor.
- Wash contaminated clothes before wearing them again.
- Dispose of the product/container in accordance with local/regional/national/international regulations.

Dilution with antifreeze: LONG LIFE is compatible with pure glycol mixtures and always with water in any proportion. Several antifreeze products on the market contain additives, however which may be not very compatible. To avoid doubt, test-mix the antifreeze solution with LONG LIFE to see how it behaves. If the components are mixed gently for a short time in the recommended proportions and then do not separate in the system, the products are compatible. If there is heavy clouding of the mixture which does not improve by stirring, the products are not compatible.

PCB PARAMETERS

The parameters stored on the PCB are essential for the correct operation.

The following parameters are already stored during the testing of the appliance directly in the factory; these parameters are the result of special tests using several types of pellets and must not be changed without the authorisation of Klover srl so as not to impair the operation of the appliance.

The company shall not be held liable for any damage caused by the incorrect entry of parameters.

PARAMETERS "VARIOUS CALIBRATIONS" - FIRMWARE (F01_090517)						
Parameter	Menu level	Description	Display	Measurement	Value field	Value (P0)
Pr38	M - 9 - 4 - 01	Re-ignition block	RE-IGNIT BLOCK	Minutes	0 - 10	6
Pr39	M - 9 - 4 - 02	Flue gas extractor switch-off time	MIN-EXT OFF	Minutes	0 - 20	10
Pr40	M - 9 - 4 - 03	Pre-loading time in ignition	IGNIT- PRE-LOAD	Seconds	0 - 225	60
Pr41	M - 9 - 4 - 04	Stand-by time after pre-loading	AFTER-PRE STAND-BY	Seconds	0 - 255	20
Pr42	M - 9 - 4 - 05	Extractor speed in pre-loading phase	FLUE GAS-EXT PRELOAD	RPM	350 - 2800	2800
Pr43	M - 9 - 4 - 06	ON/OFF Temperature hysteresis on "SET H2O" and "SET DHW"	DELTA ON OFF AUTO	°C	0 - 20	5
Pr44	M - 9 - 4 - 07	Delay at economy operation mode switch-off (timer after reaching "SET H2O")	DELAY-OFF AUTO	Minutes	2 - 120	30
Pr45	M - 9 - 4 - 08	Power change delay	POWER CHANGE	Seconds	0 - 60	20
Pr46	M - 9 - 4 - 09	ON/OFF Temperature hysteresis on "SET ROOM"	DELTA ON AUTO	°C	0 - 15	2
Pr47	M - 9 - 4 - 10	Keypad lock enable	KEY LOCK-EN	On - Off	On - Off	Off
Pr48	M - 9 - 4 - 11	Automatic re-ignition after blackout	BLACK OUT ALARM	Seconds	0 - 60	30
Pr49	M - 9 - 4 - 12	Pellet level sensor enable	PELLET RESERVE	On - Off	On - Off	Off
Pr50	M - 9 - 4 - 13	Pump start for over-temperature safety	PUMP SAFETY	°C	60 - 90	83
Pr51	M - 9 - 4 - 14	DHW temperature setpoint	DHW SET	°C	55 - 80	75
Pr52	M - 9 - 4 - 15	Preheating time	PREHEATING TIME	Seconds	0 - 480	50
Pr53	M - 9 - 4 - 16	Extractor speed in preheating phase	PREHEAT-F.GAS-SPEED	RPM	500 - 2800	2800
Pr54	M - 9 - 4 - 17	Time after which the alarm "NO PELLETS" goes if "PELLET RESERVE"	RESERVE ALARM	Minutes	1 - 180	35
Pr55	M - 9 - 4 - 18	Water level sensor enable	H2O LEVEL	On - Off	On - Off	On
Pr56	M - 9 - 4 - 19	Recirculation pump activation threshold	R-PUMP THRESHOLD	°C	30 - 70	50
Pr57	M - 9 - 4 - 20	Minimum temperature of the wood flue gas in order to consider the wood side on	WOOD THRESHOLD	°C	80 - 500	150
Pr58	M - 9 - 4 - 21	Temperature below which the pellet side comes on (if Menu 10 = ON)	PELL-ON THRESHOLD	40 - 75	40 - 75	60
Pr59	M - 9 - 4 - 22	Pellet side ignition time if there are the conditions after the wood sides is switched off	PELL-ON TIMER	Minutes	1 - 50	5

PARAMETERS "FACTORY CALIBRATIONS" - FIRMWARE (F01_090517)						
Parameter	Menu level	Description	Display	Measurement	Value field	Value (P0)
Pr01	M - 9 - 6 - 01	Ignition cycle maximum time	IGNIT- MINUTES	Minutes	5 - 25	19
Pr02	M - 9 - 6 - 02	Start time	START MINUTES	Minutes	2 - 12	4
Pr03	M - 9 - 6 - 03	Time interval between the two brazier cleaning operations	BRAZIER CLEANING	Minutes	3 - 240	60
Pr04	M - 9 - 6 - 04	Screw feed gear motor ON time in ignition phase	IGNIT- SCREW FEED	Seconds	0.1 - 8.0	2.4
Pr05	M - 9 - 6 - 05	Screw feed gear motor ON time in start phase	SCREW FEED START	Seconds	0.1 - 8.0	2.0
Pr06	M - 9 - 6 - 06	Screw feed gear motor ON time in power 1 work phase	OUTPUT 1 SCREW FEED	Seconds	0.1 - 8.0	2.2
Pr07	M - 9 - 6 - 07	Screw feed gear motor ON time in power 2 work phase	OUTPUT 2 SCREW FEED	Seconds	0.1 - 8.0	3.4

Pr08	M – 9 – 6 – 08	Screw feed gear motor ON time in power 3 work phase	OUTPUT 3 SCREW FEED	Seconds	0.1 – 8.0	4.7
Pr09	M – 9 – 6 – 09	Screw feed gear motor ON time in power 4 work phase	OUTPUT 4 SCREW FEED	Seconds	0.1 – 8.0	6.0
Pr10	M – 9 – 6 – 10	Screw feed gear motor ON time in power 5 work phase	OUTPUT 5 SCREW FEED	Seconds	0.1 – 8.0	7.0
Pr11	M – 9 – 6 – 11	Alarm delay	ALARM DELAY	Seconds	1 – 90	20
Pr12	M – 9 – 6 – 12	Brazier cleaning duration	CLEANING DURATION	Seconds	0 – 120	60
Pr13	M – 9 – 6 – 13	Pellet side flue gas minimum temperature in order to consider the appliance on	PELLET THRESHOLD	°C	40 – 180	45
Pr14	M – 9 – 6 – 14	Pellet flue gas maximum temperature	MAXIMUM THRESHOLD	°C	110 – 250	250
Pr15	M – 9 – 6 – 15	Flue gas temperature threshold for the air exchanger start-up (NOT USED)	FAN THRESHOLD	°C	50 – 210	210
Pr16	M – 9 – 6 – 16	Flue gas extraction speed in ignition phase	IGNIT FLUE GAS SPEED	RPM	500 – 2800	2400
Pr17	M – 9 – 6 – 17	Flue gas extraction speed in start phase	START FLUE GAS SPEED	RPM	500 – 2800	2300
Pr18	M – 9 – 6 – 18	Flue gas extraction speed in power 1 work phase	P 1 FLUE GAS SPEED	RPM	500 – 2800	1700
Pr19	M – 9 – 6 – 19	Flue gas extraction speed in power 2 work phase	P 2 FLUE GAS SPEED	RPM	500 – 2800	1800
Pr20	M – 9 – 6 – 20	Flue gas extraction speed in power 3 work phase	P 3 FLUE GAS SPEED	RPM	500 – 2800	1950
Pr21	M – 9 – 6 – 21	Flue gas extraction speed in power 4 work phase	P 4 FLUE GAS SPEED	RPM	500 – 2800	2050
Pr22	M – 9 – 6 – 22	Flue gas extraction speed in power 5 work phase	P 5 FLUE GAS SPEED	RPM	500 – 2800	2250
Pr23	M – 9 – 6 – 23	Exchanger 1 motor speed in output 1 working mode (NOT USED)	AIR 1 SPEED	Volt	65 – 225	65
Pr24	M – 9 – 6 – 24	Exchanger 1 motor speed in output 2 working mode (NOT USED)	AIR 2 SPEED	Volt	65 – 225	65
Pr25	M – 9 – 6 – 25	Exchanger 1 motor speed in output 3 working mode (NOT USED)	AIR 3 SPEED	Volt	65 – 225	65
Pr26	M – 9 – 6 – 26	Exchanger 1 motor speed in output 4 working mode (NOT USED)	AIR 4 SPEED	Volt	65 – 225	65
Pr27	M – 9 – 6 – 27	Exchanger 1 motor speed in output 5 working mode (NOT USED)	AIR 5 SPEED	Volt	65 – 225	65
Pr28	M – 9 – 6 – 28	Flue gas extractor switch-off threshold (in switch-off phase)	THRESHOLD OFF	°C	50 – 180	60
Pr29	M – 9 – 6 – 29	Flue gas extraction speed in brazier cleaning phase	FLUE GAS-EXT CLEANING	RPM	500 – 2800	2800
Pr30	M – 9 – 6 – 30	Screw feed gear motor ON time in cleaning phase	CLEANING SCREW FEED	Seconds	0.1 – 8.0	1.5
Pr31	M – 9 – 6 – 31	Flue gas extractor encoder enable (NOT USED)	ENCODER	On – Off	On – Off	On
Pr32	M – 9 – 6 – 32	Screw feed brake time	BRAKE TIME	Seconds	0 – 0.5	0.2
Pr33	M – 9 – 6 – 33	Pump activation threshold	PUMP THRESHOLD	°C	20 – 70	55
Pr34	M – 9 – 6 – 34	Water pressure switch enable (NOT USED)	WATER PRESSURESW.	On – Off	On – Off	Off
Pr35	M – 9 – 6 – 35	Water pressure threshold (NOT USED)	PRESSURE THRESHOLD	Bar	1.5 – 3.0	2.5
Pr36	M – 9 – 6 – 36	Screw feed motor reducer ON time in DHW output working mode	DHW SCREW FEED	Seconds	0.1 – 8.0	7.0
Pr37	M – 9 – 6 – 37	Flue gas intake speed in DHW output working mode	DHW FLUE GAS-INTAKE DEVICE	RPM	500 – 2800	2250

WIRING DIAGRAM

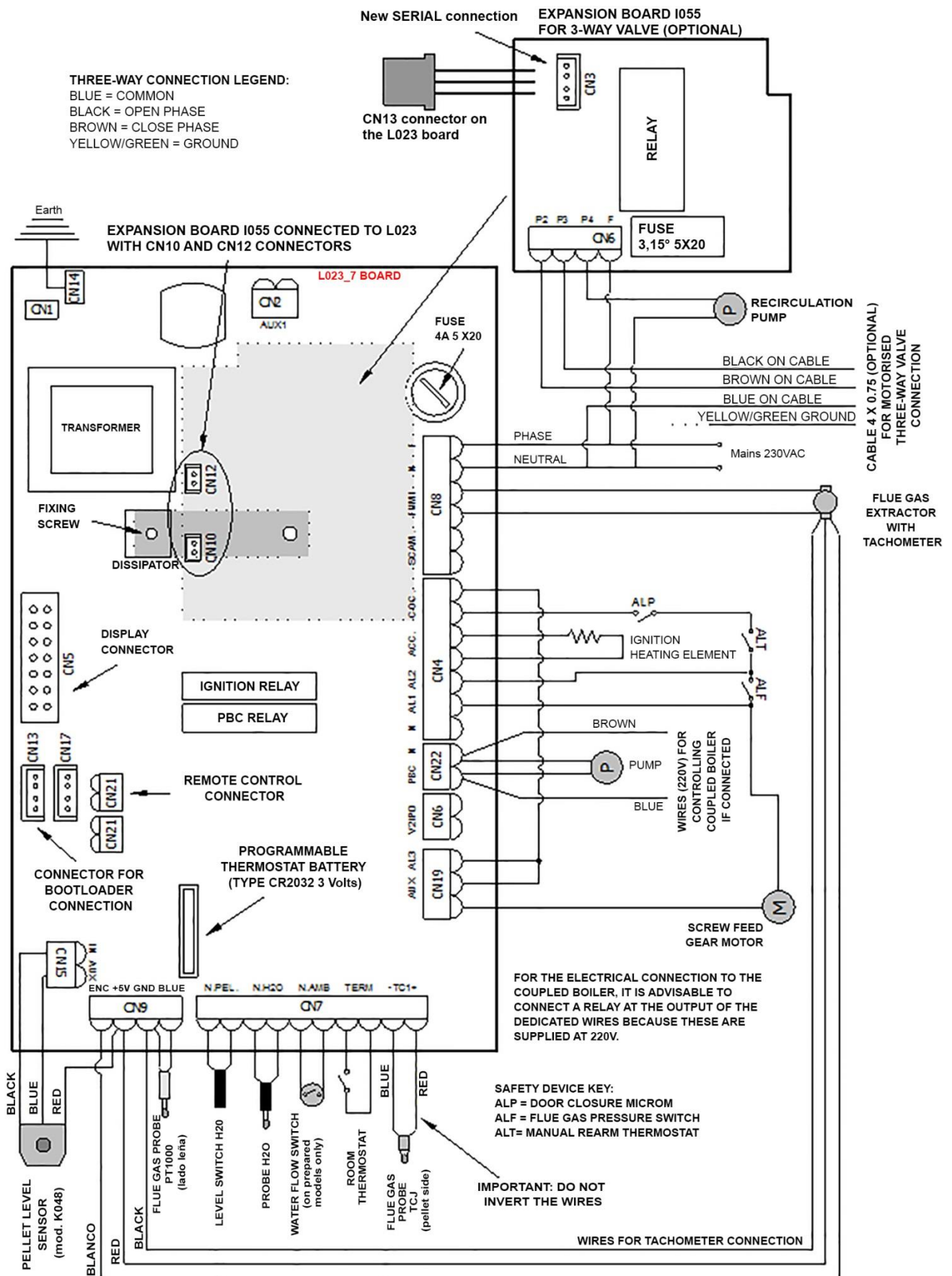

WARRANTY CONDITIONS

The warranty starts from the date of purchase of the product, which must be demonstrated by a delivery document and by the initial start-up report issued by the Authorised Technical Service Centre. These documents must be shown to the Technical Assistance Centre, if required.

- A copy of the initial start-up report issued by the Authorised Technical Assistance Centre must be preserved along with the proof of purchase receipt.
- KLOVER s.r.l. disclaims any liability for accidents resulting from failure to comply with the instructions contained the user and maintenance manual attached to the appliance.
- Furthermore, KLOVER s.r.l. declines any liability arising from misuse of the product by the user, unauthorized modifications and/or repairs, as well as the use of non-original spare parts or parts not suitable for this type of product.

KLOVER s.r.l. guarantees the quality of materials, good construction and functionality of the product for a period of 2 years, under the following conditions:

1. On its own unquestionable judgement, the device evidencing material or construction faults will be repaired or replaced; with the exception of all costs relating to transport, restoration (hydraulic disassembly and assembly operations, any masonry works and any other necessary intervention) and accessory materials;
2. The warranty does not cover:
 - the ceramic glass and ceramic-majolica and/or varnished steel linings, as they are very fragile and can get accidentally damaged;
 - any part made of ceramic-majolica evidencing altered colour shades, pitting, cracks, shading and slight dimensional variations, as these cannot be regarded as product defects but features deriving from the handmade processing techniques used;
 - the cast iron brazier, the cast iron grid and plate, smoke deflector or flame arresters, gaskets, fuses or batteries inside the device's electronic system and any other removable component, where it is not proved that their condition is due to a manufacturing defect rather than the effects of wear;
 - electric and electronic parts, in which the malfunction can be traced to a non-compliant electrical connection, natural disaster (lightning, electrical discharges, etc.) and variation in voltage other than the nominal voltage;
 - any parameter calibration intervention due to the type of fuel or installation of the device.
3. The replaced components are guaranteed for the remaining period of the warranty, starting from the date of purchase and/or for a period not exceeding 6 months;
4. The use of poor-quality wood pellets or other fuel could damage the components of the device thereby voiding the relevant warranty and the manufacturer's liability. Therefore, we recommend using the fuel type indicated in our specifications;
5. Incorrect installation carried out by unqualified personnel, tampering with, failure to comply with the instructions contained in this "use and maintenance manual" and those regarding "workmanlike installation" shall void any warranty rights; the same applies to damages deriving from external factors. At all events, any compensation for direct or indirect damages is excluded, regardless of the nature and cause of the damages;
6. Please bear in mind that the goods travel under the customer's responsibility, even if delivered carriage free, therefore we shall not be held liable for any damages due to loading and unloading operations, accidental knocks, storage in unsuitable places, etc.;
7. The boiler unit of water-based products only connected to a heating and/or sanitary water system is guaranteed for 5 years, at the above-mentioned conditions.
8. The warranty is to be considered valid only if the initial start-up report and warranty start is duly completed in all its parts by the Authorised Technical Assistance Centre at the first ignition. For the validity of the warranty, the first ignition **must only be carried out by the Authorized Technical Assistance Centre within 3 months from the date of purchase and no later than 30 days from date of installation;**

The competent law court for settling any disputes is the Court of Verona.

KLOVER
F U O C O E P A S S I O N E

KLOVER Srl

Via A. Volta, 8
37047 San Bonifacio (VR)
VAT No. 02324280235
www.klover.it