

WSAN-YMi

21 - 81



MANUAL

FOR INSTALLATION,
USE AND MAINTENANCE

Remote On - Off

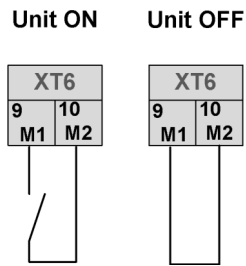

Domestic Hot Water

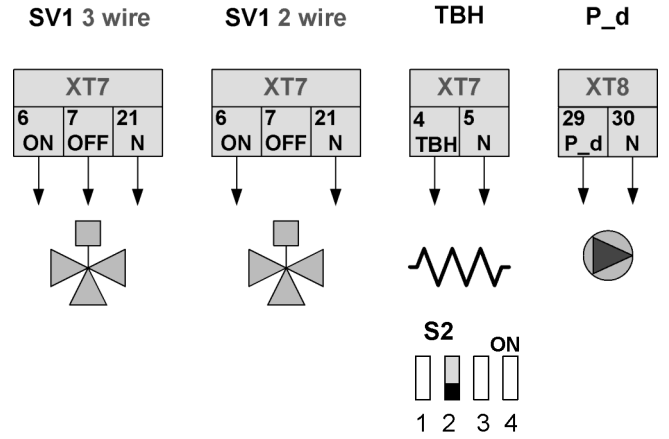
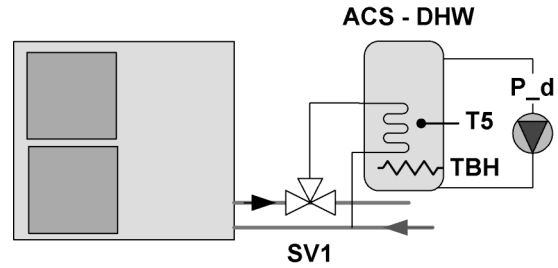

External signals

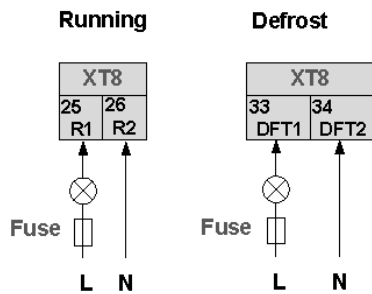

MENU
FOR SERVICEMAN
DHW MODE SETTING



Boiler

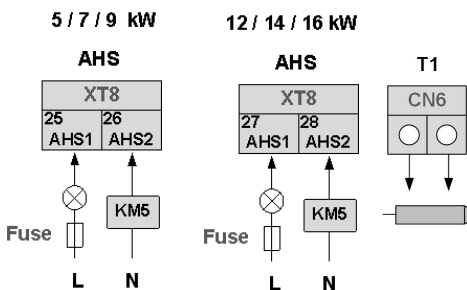
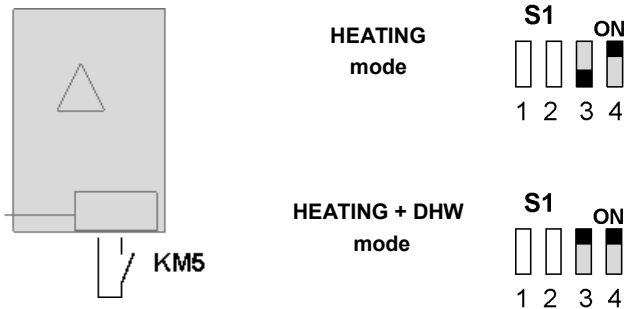

Solar panels

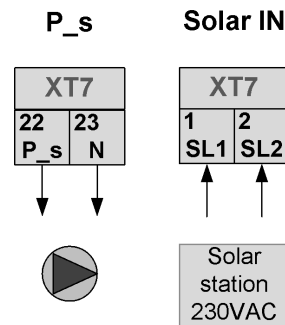
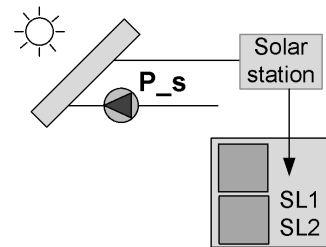

MENU
FOR SERVICEMAN
OTHER HEATING SOURCE



MENU
FOR SERVICEMAN
OTHER HEATING SOURCE



Backup Heater

Thermostat

12 / 14 / 16 kW

5 / 7 / 9 / 12 /
14 / 16 kW

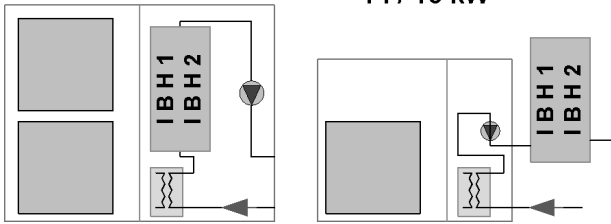

IBH1

IBH2

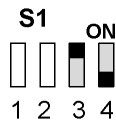
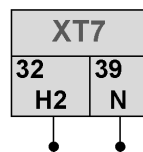
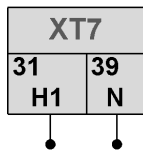

MENU
FOR SERVICEMAN
OTHER HEATING SOURCE

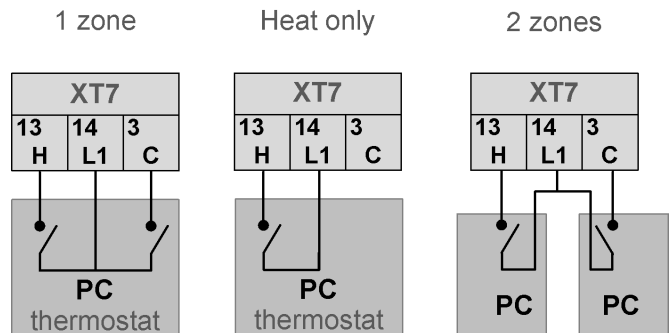

MENU
FOR SERVICEMAN
ROOM THERMOSTAT = YES
MODE SETTING = YES



Radiant panels and fancoil
- mixed

Radiant panels and fancoil
- not mixed

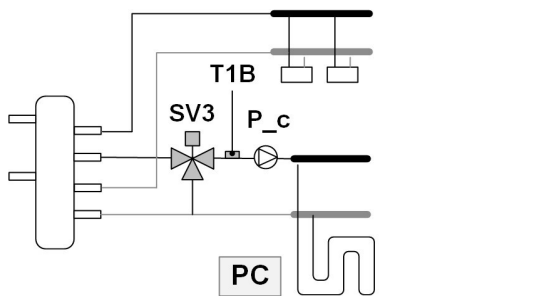

SV3

PC

P_c

T1B

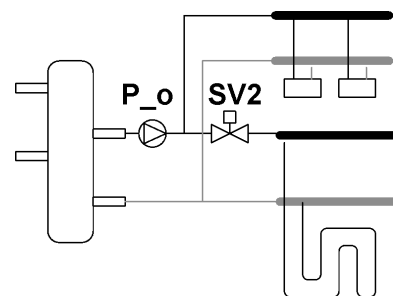
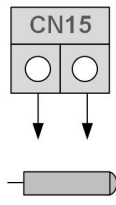
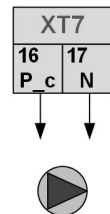
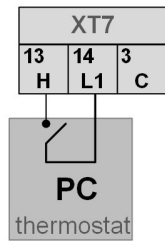
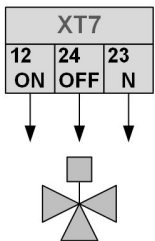

SV2

P_o

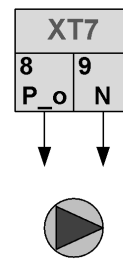
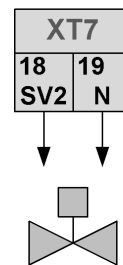

Dear Customer,

We congratulate you on choosing this product

For many years Clivet has been offering systems that provide maximum comfort, together with high reliability, efficiency, quality and safety.

The aim of the company is to offer advanced systems, that assure the best comfort, reduce energy consumption and the installation and maintenance cost for the life cycle of the system.

The purpose of this manual is to provide you with information that is useful from reception of the equipment, through installation, operational usage and finally disposal so that this advanced system offers the best solution.

Yours faithfully.

CLIVET Spa

The data contained in this manual is not binding and may be changed by the manufacturer without prior notice.
Reproduction, even in part, is FORBIDDEN © Copyright - CLIVET S.p.A. - Feltre (BL) - Italia

CONTENTS

1	Series	6
2	Safety considerations	7
3	General information	11
4	Installation	14
5	Water connections	20
6	Electrical connections	31
7	Start-up and configuration	46
8	Service information	65
9	Maintenance - service	69
10	Trouble shooting	71
11	Modbus mapping table	80
12	Controller user manual	86
13	Controller navigation menu	110
14	General technical data	112

Product line			
Size	Nominal kW	Power supply	
21	5	230M	1-phase
31	7	230M	1-phase
41	9	230M	1-phase
61	12	230M	1-phase
71	14	230M	1-phase
81	16	230M	1-phase
61	12	400TN	3-phase
71	14	400TN	3-phase
81	16	400TN	3-phase

2 SAFETY PRECAUTIONS

The precautions listed here are divided into the following types. They are quite important, so be sure to follow them carefully. Meanings of DANGER, WARNING, CAUTION and NOTE symbols.

DANGER

Indicates an imminently hazardous situation which if not avoided, will result in death or serious injury.

WARNING

Indicates a potentially hazardous situation which if not avoided, could result in death or serious injury.

CAUTION

Indicates a potentially hazardous situation which if not avoided, may result in minor or moderate injury. It is also used to alert against unsafe practices.

NOTE

Indicates situations that could only result in accidental equipment or property damage.

WARNING

- Read these instructions carefully before installation. Keep this manual in a handy for future reference.
- Improper installation of equipment or accessories may result in electric shock, short-circuit, leakage, fire or other damage to the equipment. Be sure to only use accessories made by the supplier, which are specifically designed for the equipment and make sure to get installation done by a professional.
- All the activities described in this manual must be carried out by a licensed technician. Be sure to wear adequate personal protection equipment such as gloves and safety glasses while installation the unit or carrying out maintenance activities.
- qualificato devono essere effettuate sotto la supervisione della persona competente per l'uso di refrigeranti infiammabili.
- Servicing shall only be performed as recommended by the equipment manufacturer. Maintenance and repair requiring the assistance of other skilled personnel shall be carried out under the supervision of the person competent in the use of flammable refrigerants.
- Contact your dealer for any further assistance.



Caution: Risk of fire/flammable materials

DANGER

Before touching electric terminal parts, turn off power switch.

When service panels are removed, live parts can be easily touched by accident.

Never leave the unit unattended during installation or servicing when the service panel is removed.

Do not touch water pipes during and immediately after operation as the pipes may be hot and could burn your hands. To avoid injury, give the piping time to return to normal temperature or be sure to wear protective gloves.

Do not touch any switch with wet fingers. Touching a switch with wet fingers can cause electrical shock.

Before touching electrical parts, turn off all applicable power to the unit.

WARNING

- Tear apart and throw away plastic packaging bags so that children will not play with them. Children playing with plastic bags face danger of death by suffocation.
- Safely dispose of packing materials such as nails and other metal or wood parts that could cause injuries.
- Ask your dealer or qualified personnel to perform installation work in accordance with this manual. Do not install the unit yourself. Improper installation could result in water leakage, electric shocks or fire
- Be sure to use only specified accessories and parts for installation work. Failure to use specified parts may result in water leakage, electric shocks, fire, or the unit falling from its mount.
- Install the unit on a foundation that can withstand its weight. Insufficient physical strength may cause the equipment to fall and possible injury.
- Perform specified installation work with full consideration of strong wind, hurricanes, or earthquakes. Improper installation work may result in accidents due to equipment falling.
- Make certain that all electrical work is carried out by qualified personnel according to the local laws and regulations and this manual using a separate circuit. Insufficient capacity of the power supply circuit or improper electrical construction may lead to electric shocks or fire.
- Be sure to install a ground fault circuit interrupter according to local laws and regulations. Failure to install a ground fault circuit interrupter may cause electric shocks and fire.
- Make sure all wiring is secure. Use the specified wires and ensure that terminal connections or wires are protected from water and other adverse external forces. Incomplete connection or affixing may cause a fire.
- When wiring the power supply, form the wires so that the front panel can be securely fastened. If the front panel is not in place there could be overheating of the terminals, electric shocks or fire.
- After completing the installation work, check to make sure that there is no refrigerant leakage.
- Never directly touch any leaking refrigerant as it could cause severe frostbite. Do not touch the refrigerant pipes during and immediately after operation as the refrigerant pipes may be hot or cold, depending on the condition of the refrigerant flowing through the refrigerant piping, compressor and other refrigerant cycle parts. Burns or frostbite are possible if you touch the refrigerant pipes. To avoid injury, give the pipes time to return to normal temperature or, if you must touch them be sure to wear protective gloves.
- Do not touch the internal parts (pump, backup heater, etc.) during and immediately after operation. Touching the internal parts can cause burns. To avoid injury, give the internal parts time to return to normal temperature or, if you must touch them, be sure to wear protective gloves.

CAUTION

- Ground the unit.
- Grounding resistance should be according to local laws and regulations.
- Do not connect the ground wire to gas or water pipes, lightning conductors or telephone ground wires.
- Incomplete grounding may cause electric shocks.
 - Gas pipes : Fire or an explosion might occur if the gas leaks.
 - Water pipes : Hard vinyl tubes are not effective grounds.
 - Lightning conductors or telephone ground wires : Electrical threshold may rise abnormally if struck by a lightning bolt.
- Install the power wire at least 3 feet (1 meter) away from televisions or radios to prevent interference or noise. (Depending on the radio waves, a distance of 3 feet (1 meter) may not be sufficient to eliminate the noise.)
- Do not wash the unit. This may cause electric shocks or fire. The appliance must be installed in accordance with national wiring regulations. If the supply cord is damaged, it must be replaced by the manufacturer, its service agent or similarly qualified persons in order to avoid a hazard.
- Do not install the unit in the following places:
 - Where there is mist of mineral oil, oil spray or vapors. Plastic parts may deteriorate, and cause them to come loose or water to leak.
 - Where corrosive gases (such as sulphurous acid gas) are produced. Where corrosion of copper pipes or soldered parts may cause refrigerant to leak.
 - Where there is machinery which emits electromagnetic waves. Electromagnetic waves can disturb the control system and cause equipment malfunction.
 - Where flammable gases may leak, where carbon fiber or ignitable dust is suspended in the air or where volatile flammables such as paint thinner or gasoline are handled. These types of gases might cause a fire.
 - Where the air contains high levels of salt such as near the ocean.
 - Where voltage fluctuates a lot, such as in factories.
 - In vehicles or vessels.
 - Where acidic or alkaline vapors are present.
- This appliance can be used by children 8 years old and above and persons with reduced physical, sensory or mental capabilities or lack of experience and knowledge if they are supervised or given instruction on using the unit in a safe manner and understand the hazards involved. Children should not play with the unit. Cleaning and user maintenance should not be done by children without supervision.
- Children should be supervised to ensure that they do not play with the appliance. If the supply cord is damaged, it must be replaced by the manufacturer or its service agent or a similarly qualified person.
- DISPOSAL: Do not dispose this product as unsorted municipal waste. Collection of such waste separately for special treatment is necessary. Do not dispose of electrical appliances as municipal waste, use separate collection facilities. Contact your local government for information regarding the collection systems available. If electrical appliances are disposed of in landfills or dumps, hazardous substance can leak into the groundwater and get into the food chain, damaging your health and well-being.
- The wiring must be performed by professional technicians in accordance with national wiring regulation and this circuit diagram. An all-pole disconnection device which has at least 3mm separation distance in all pole and a residual current device(RCD) with the rating not exceeding 30mA shall be incorporated in the fixed wiring according to the national rule.

2 SAFETY PRECAUTIONS

- Confirm the safety of the installation area (walls, floors, etc.) without hidden dangers such as water, electricity, and gas. Before wiring/pipes.
- Before installation , check whether the user's power supply meets the electrical installation requirements of unit (including reliable grounding , leakage , and wire diameter electrical load, etc.). If the electrical installation requirements of the product are not met, the installation of the product is prohibited until the product is rectified.
- When installing multiple air conditioners in a centralized manner, please confirm the load balance of the three-phase power supply, and multiple units are prevented from being assembled into the same phase of the three-phase power supply.
- Product installation should be fixed firmly, Take reinforcement measures, when necessary.

NOTE

About Fluorinated Gasses

This air-conditioning unit contains fluorinated gasses. For specific information on the type of gas and the amount, please refer to the relevant label on the unit itself. Compliance with national gas regulations shall be observed.

Installation, service, maintenance and repair of this unit must be performed by a certified technician.

Product uninstallation and recycling must be performed by a certified technician.

If the system has a leak-detection system installed, it must be checked for leaks at least every 12 months. When the unit is checked for leaks, proper record-keeping of all checks is strongly recommended.

REFRIGERANT INFORMATION

This product has the fluorinated gas, it is forbidden to release to air.

Refrigerant type: R32;

Volume of GWP: 675.

GWP=Global Warming Potential

Model	Factory charged refrigerant volume in the unit	
	Refrigerant/kg	Tonnes CO ₂ equivalent
5kW	2.00	1.35
7kW	2.00	1.35
9kW	2.00	1.35
12kW	2.80	1.89
14kW	2.80	1.89
16kW	2.80	1.89

CAUTION

This air-conditioning unit is a hermetically sealed equipment that contains fluorinated greenhouse gases.

Only certificated person is allowed to do installation, operation and maintenance.

Frequency of Refrigerant Leakage Checks

For unit that contains fluorinated greenhouse gases in quantities of 5 tonnes of CO₂ equivalent or more, but of less than 50 tonnes of CO₂ equivalent, at least every 12 months, or where a leakage detection system is installed, at least every 24 months.

Only certificated person is allowed to do installation, operation and maintenance.

3 GENERAL INFORMATION

These units are used for both heating and cooling applications.

They can be combined with fan coil units, floor heating applications, low temperature high efficiency radiators, domestic hot water tanks (not supplied) and solar kits (not supplied).

A wired controller is supplied with the unit .

Antifreeze function

The unit have a freeze prevention function that uses the heat pump and backup heater (option) to keep the water system safe from freezing in all conditions. Since a power failure may happen when the unit is unattended, It's suggested to use anti-freezing flow switch in the water system. (Refer to Water piping).

Backup heater

The backup heater can increase the heating capacity during cold outdoor temperatures.

The backup heater also serves as a backup in case of malfunctioning and for freeze protection of the outside water piping during winter time.

The capacity of backup heater for different units is listed below.

The standard unit is without backup heater.

The backup heater kit is an optional part for the 5,7,9kW models.

The backup heater can be integrated into the unit for custom models (12,14,16kW).

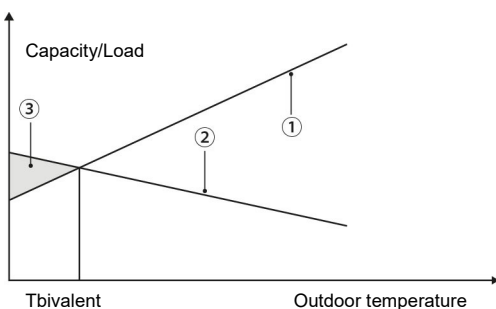

1. Heat pump capacity.
2. Required heating capacity (site dependent).
3. Additional heating capacity provided by backup heater.

Unit power supply	1-phase						3-phase		
Nominal power (kW)	5	7	9	12	14	16	12	14	16
Backup heater (kW)	3			3 o 4,5			4,5		

NOTE

The picture and function described in this manual contain the backup heater components.

Room thermostat

Not supplied

Room thermostat can be connected to the unit(room thermostat should be kept away from heating source when selecting the installation place).

Solar kit for domestic hot water tank

Not supplied

An optional solar kit can be connected to the unit.

Remote alarm kit

Not supplied

A remote alarm kit can be connected to the unit.

Domestic hot water tank

Not supplied.

A domestic hot water tank (with or without booster heater) can be connected to the unit.

See table for specific tank.

If the tank volume is greater than 240L, the temperature probe (T5) should be installed at a position higher than half of the tank's height.

If the tank volume is less than 240L, the temperature probe should be installed at a position higher than 2/3 of the tank's height.

The booster heater should be installed below the temperature probe.

The heat exchanger (coil) should be installed below the temperature probe.

Especially in case of considerable distances between the unit and the DHW storage tank, suitably size the connection pipes and take care of the thermal insulation of the pipes themselves.

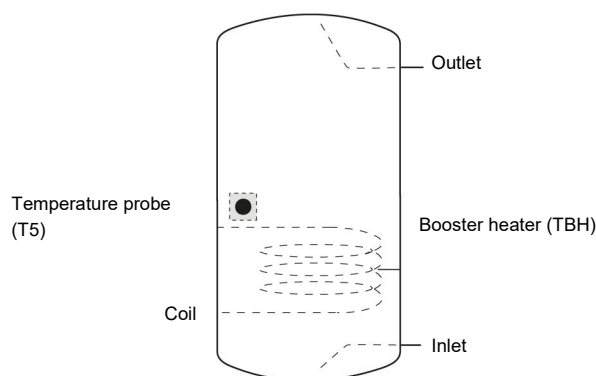

Unit		5-9 kW	12-16 kW	
Volume of tank/L		Minimum	100	200
		Recommended	200	300
Heat exchanger (Stainless steel coil)	Heat exchange area/m ²	Minimum	1.4	1.75
		Recommended	2.5	4
	Volume/L	Minimum	12	14
		Recommended	20	32
Heat exchanger (Enamel coil)	Area di scambio termico/m ²	Minimum	1.7	2.5
		Recommended	3	5.6
	Volume/L	Minimum	14	20
		Recommended	24	45

Accessories supplied with the unit

Installation Fittings		
Name	Quantity	
	5~9kW	12~16kW
Installation and owner's manual(this book)	1	1
Y-shape filter	1	1
Water outlet connection pipe assembly	2	1
Wired controller	1	1
Tighten belt for customer wiring use	0	2
	3	3
Thermistor for domestic hot water tank or additional heating source*	1	1
Extension wire for T5	1	1

* The thermistor can be used to detect temperature of water.

- If domestic hot water tank is installed only, the thermistor can work as T5.
- If boiler is installed only, the thermistor can work as T1
- If both unit are installed, an additional thermistor is needed(please contact the supplier).

The thermistor should connect to the corresponding port in the main control board of hydraulic module

Accessories available from supplier

Water temperature thermistor - T1

Extension wire - for T1

Example of positioning T5 and T1

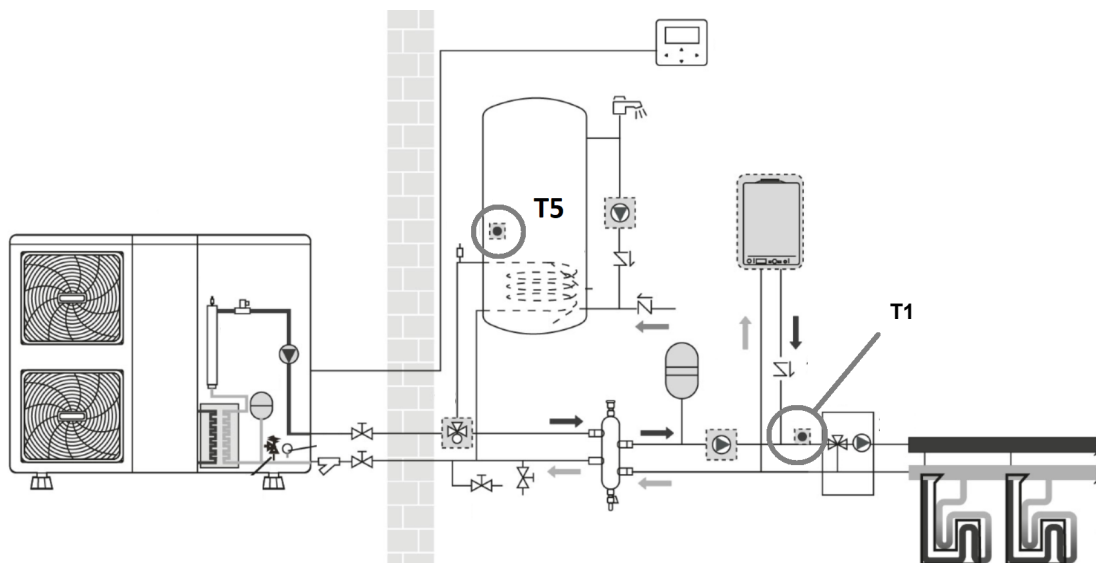

Before installation

Be sure to confirm the model name and the serial number of the unit.

Handling

Due to relatively large dimensions and heavy weight, the unit should only be handled using lifting tools with slings. The slings can be fitted into foreseen sleeves at the base frame that are made specifically for this purpose.

CAUTION

To avoid injury, do not touch the air inlet or aluminum fins of the unit.
Do not use the grips in the fan grills to avoid damage.
The unit is top heavy! Prevent the unit from falling due to improper inclination during handling.

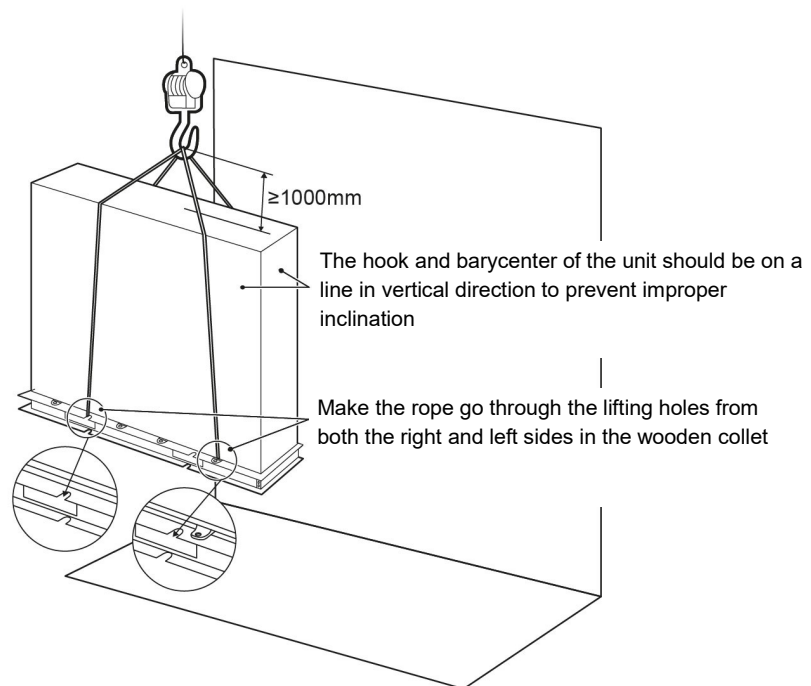

The position of barycenter the unit

5/7/9 kW

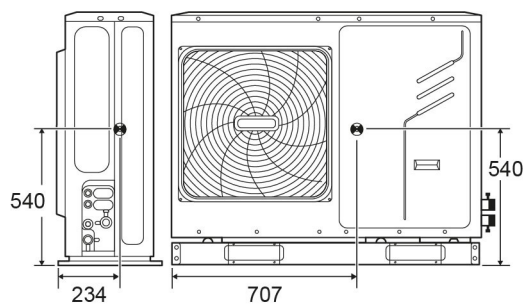

12/14/16 kW

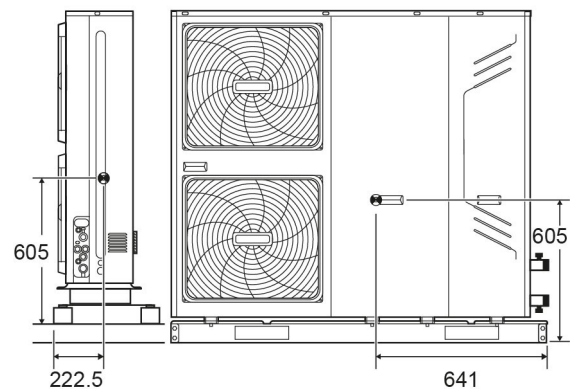

ATTENZIONE

There is flammable refrigerant in the unit and it should be installed in a well-ventilated site. If the unit is installed inside, an additional refrigerant detection device and ventilation equipment must be added in accordance with the standard EN378.

Be sure to adopt adequate measures to prevent the unit from being used as a shelter by small animals.

Small animals making contact with electrical parts can cause malfunction, smoke or fire.

Please instruct the customer to keep the area around the unit clean.

Select an installation site where the following conditions are satisfied and one that meets with your customer's approval.

- Places that are well-ventilated.
- Places where the unit does not disturb next-door neighbors.
- Safe places which can bear the unit's weight and vibration and where the unit can be installed at an even level.
- Places where there is no possibility of flammable gas or product leak.
- The equipment is not intended for use in a potentially explosive atmosphere.
- Places where servicing space can be well ensured.
- Places where the units' piping and wiring lengths come within the allowable ranges.
- Places where water leaking from the unit cannot cause damage to the location (e.g. in case of a blocked drain pipe).
- Places where rain can be avoided as much as possible.
- Do not install the unit in places often used as a work space. In case of construction work (e.g. grinding etc.) where a lot of dust is created, the unit must be covered.
- Do not place any object or equipment on top of the unit (top plate)
- Do not climb, sit or stand on top of the unit.
- Be sure that sufficient precautions are taken in case of refrigerant leakage according to relevant local laws and regulations.
- Don't install the unit near the sea or where there is corrosion gas.

When installing the unit in a place exposed to strong wind, pay special attention to the following.

Strong winds of 5 m/sec or more blowing against the unit's air outlet causes a short circuit (suction of discharge air), and this may have the following consequences:

- Deterioration of the operational capacity.
- Frequent frost acceleration in heating operation.
- Disruption of operation due to rise of high pressure.
- When a strong wind blows continuously on the front of the unit, the fan can start rotating very fast until it breaks.

In normal condition, refer to the figures below for installation of the unit:

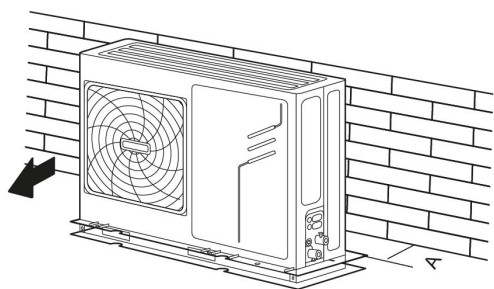

Unit	A(mm)
5~9kW	≥300
12~16kW	≥300

In case of strong wind and the wind direction can be foreseen, refer to the figures below for installation of the unit (any one is OK):

Turn the air outlet side toward the building's wall, fence or screen.

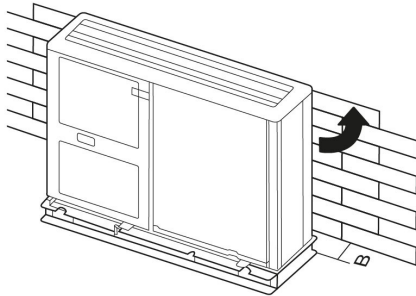

Unit	A(mm)
5~9kW	≥1000
12~16kW	≥1500

Make sure there is enough room to do the installation.
Set the outlet side at a right angle to the direction of the wind.

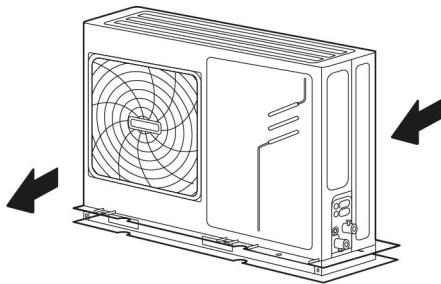

Prepare a water drainage channel around the foundation, to drain waste water from around the unit.
If water does not easily drain from the unit, mount the unit on a foundation of concrete blocks, etc. (the height of the foundation should be about 100 mm (3.93 in)).
If you install the unit on a frame, please install a waterproof plate (about 100 mm) on the underside of the unit to prevent water from coming in from the low side.
When installing the unit in a place frequently exposed to snow, pay special attention to elevate the foundation as high as possible
If you install the unit on a building frame, please install a waterproof plate (not supplied) (about 100mm, on the underside of the unit) in order to avoid drain water dripping. (See the picture in the right).



NOTE

Unit is top heavy!
Try not to install on the building frame.

Selecting a location in hot climates

As the outdoor temperature is measured via the outdoor unit air thermistor, make sure to install the outdoor unit in the shade or a canopy should be constructed to avoid direct sunlight, so that it is not influenced by the sun's heat, otherwise protection may be possible to the unit.

Selecting a location in cold climates

To prevent exposure to wind, install the unit with its suction side facing the wall.

Never install the unit at a site where the suction side may be exposed directly to wind.

To prevent exposure to wind, install a baffle plate on the air discharge side of the unit.

In heavy snowfall areas, it is very important to select an installation site where the snow will not affect the unit. If lateral snowfall is possible, make sure that the heat exchanger coil is not affected by the snow (if necessary construct a lateral canopy).

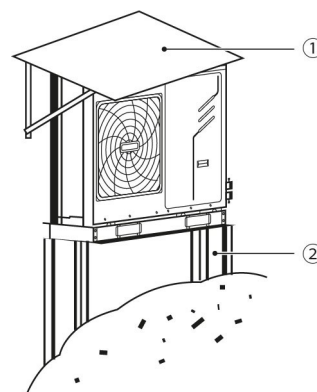

1. Construct a large canopy.
2. Construct a pedestal.

Install the unit high enough off the ground to prevent it from being buried in snow.

Installation requirements

Check the strength and level of the installation ground so that the unit may not cause any vibrations or noise during its operation. In accordance with the foundation drawing in the figure, fix the unit securely by means of foundation bolts. (Prepare four sets each of $\Phi 10$ Expansion bolts, nuts and washers which are readily available in the market.)
Screw in the foundation bolts until their length is 20 mm from the foundation surface.

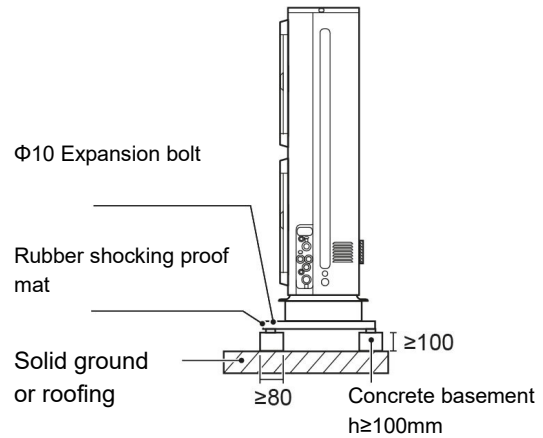
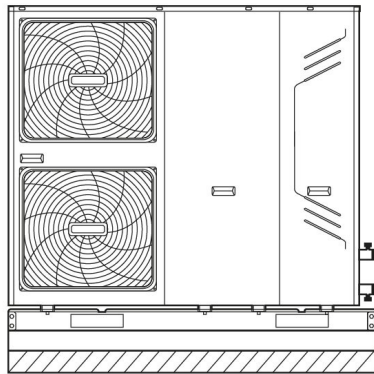

(unit:mm)

Drain hole position

5 / 7 / 9 kW

12 / 14 / 16 kW

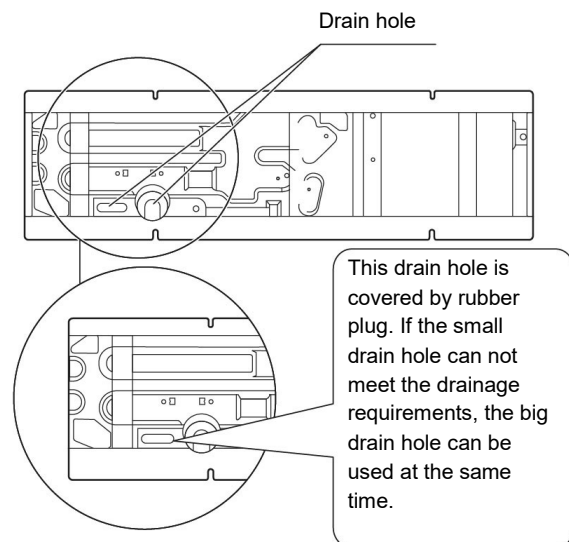
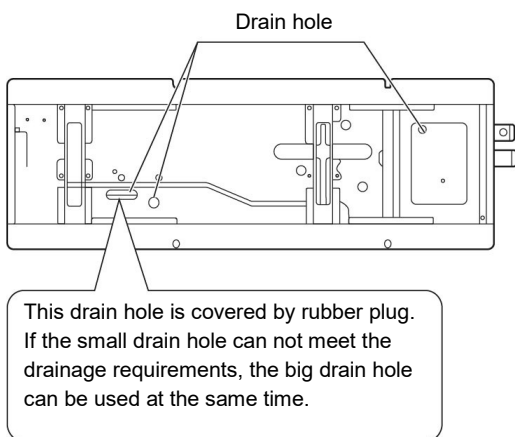

NOTE

It's necessary to install an electrical heating belt if water can't drain out in cold weather even the big drain hole has opened.

Servicing space requirements

In case of stacked installation

1) In case obstacles exist in front of the outlet side.

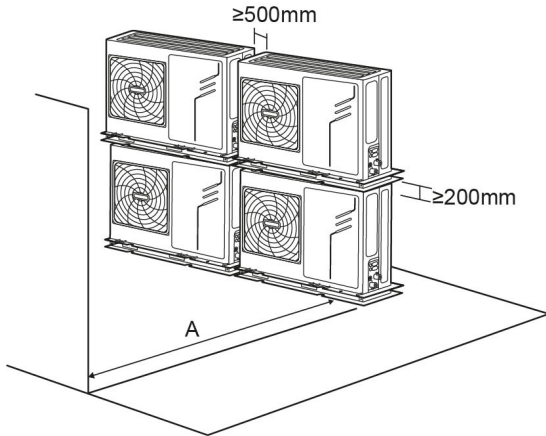

2) In case obstacles exist in front of the air inlet.

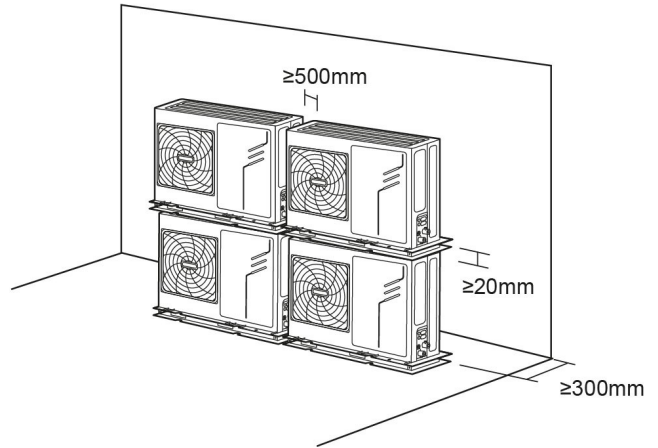

Unit	A(mm)
5~9kW	≥1000
12~16kW	≥1500

In case of multiple-row installation (for roof top use, etc.)

1) In case of installing one unit per row.

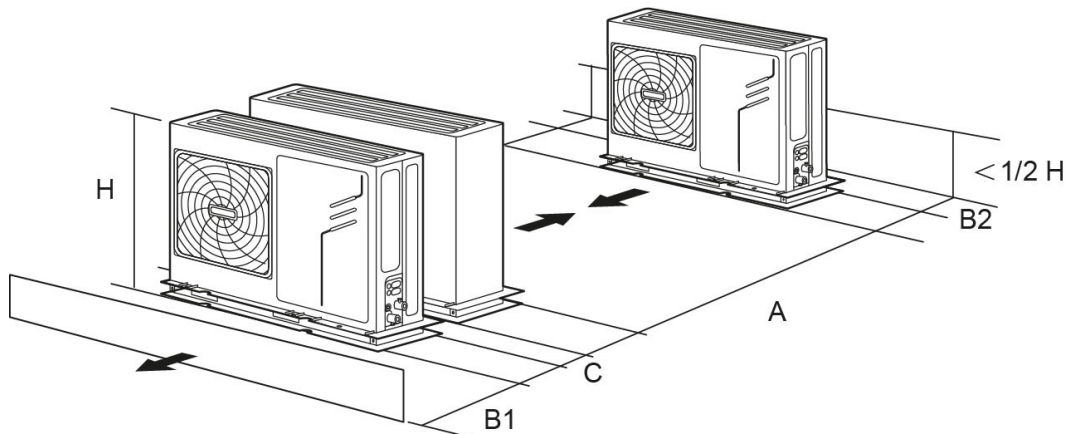

Unit	A(mm)	B1(mm)	B2(mm)	C(mm)
5~9kW	≥1500	≥500	≥150	≥300
12~16kW	≥2000	≥1000	≥150	≥300

2) In case of installing multiple units in lateral connection per row.

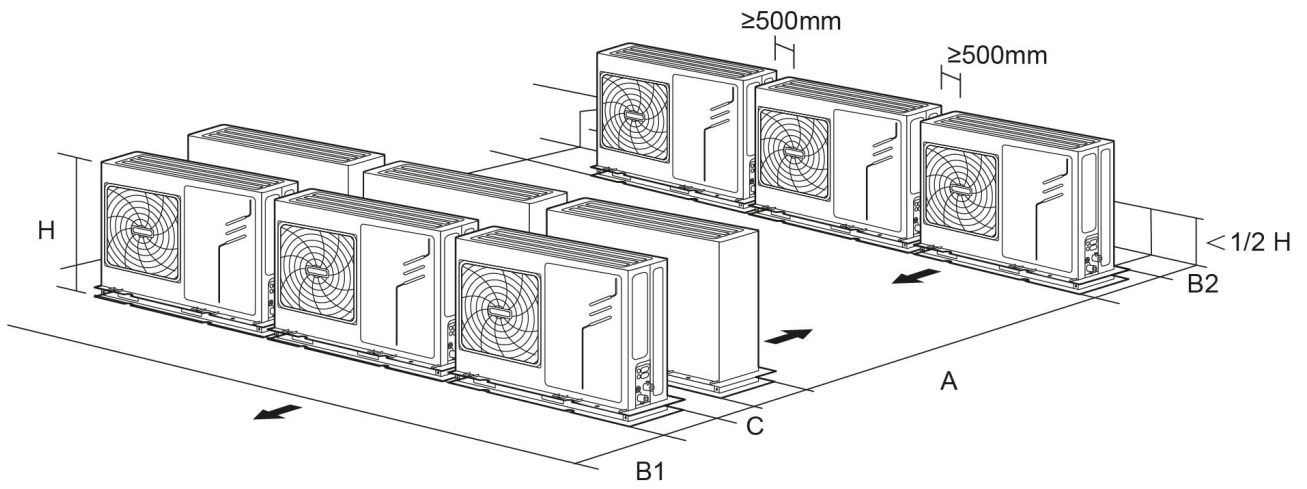

Unit	A(mm)	B1(mm)	B2(mm)	C(mm)
5 / 7 / 9kW	≥ 2500	≥ 1000	≥ 300	≥ 600
12 / 14 / 16kW	≥ 3000	≥ 1500	≥ 300	≥ 600

Water features

- confirming to local regulations
 - Langelier (IL) index between 0 and +0.4
 - within the limits indicated by table
- The water quality must be checked by qualified personnel.

Water component for corrosion limit on Copper		
PH	7,5 ÷ 9,0	
SO ₄ ²⁻	< 100	
HCO ₃ ⁻ / SO ₄ ²⁻	> 1	
Total Hardness	8 ÷ 15	°f
Cl ⁻	< 50	ppm
PO ₄ ³⁻	< 2,0	ppm
NH ₃	< 0,5	ppm
Free Chlorine	< 0,5	ppm
Fe ₃ ⁺	< 0,5	ppm
Mn ⁺⁺	< 0,05	ppm
CO ₂	< 50	ppm
H ₂ S	< 50	ppb
Temperature	< 65	°C
Oxygen content	< 0,1	ppm
Sand	10 mg/L 0.1 to 0.7mm max diameter	
Ferrite hydroxide Fe ₃ O ₄ (black)	Dose < 7.5 mg/L 50% of mass with diameter < 10 µm	
Iron oxide Fe ₂ O ₃ (red)	Dose < 7.5mg/L	

CAUTION

Circulators operate best with clean, good quality tap water. The most frequently occurring factors which may have a negative effect on heating water can be oxygen, lime, sludge, acidity level and other substances (including chlorides and minerals). In addition to the heating water quality, the installation also plays a significant part.

Hardness

If the water hardness is high install a system suitable to preserve the unit from harmful deposits and limestone formations.

If necessary, fit a water softener to reduce water hardness.

Cleaning

Before making the water connections to unit clean carefully the system with specific and effective products for removing residues or impurities that could affect the operation. The existing systems must be free from sludges, contaminants and protected against foulings.

New heating systems

In the case of new installations, it is first of all crucial to flush the entire installation thoroughly (without the circulator mounted) before the central installation is commissioned. This will remove residues from the installation process (weld, slag, fitting products...) and preservatives (including mineral oil). The system shall then be filled with clean, good quality tap water.

Existing heating systems

If a new boiler or heat pump is being installed in an existing heating system, the system must be flushed to avoid particles presence, sludge and other problems in the installation. Where applicable, flushing shall be done before the new application is installed. Loose dirt can only be removed where there is sufficient flow. Flushing will therefore take place section by section. Special attention must also be paid to "blind spots", where there is only a small amount of flow and where a lot of dirt can be accumulated. The system shall then be filled with clean, good quality tap water. If after the flushing the quality of the water in an existing installation still proves to be inadequate, certain measures must be taken to avoid circulator problems. One option for removing pollution is to install a filter. Various kinds of filters are available for this. A screen filter is designed to trap large dirt particles. This filter is usually placed in the full flow part of the system. A fabric filter on the other hand, is designed to trap finer particles.

Exclusions

The warranty does not cover damages caused by limestone formations, deposits and impurities from the water supply and / or failure from failed system clearing to clean system.

Hydraulic system diagram

Beckup Heater Kit

5 / 7 / 9 / 12 / 14 / 16 kW

Option

Installation outside the unit

Resistance power: 3kW 1-phase 5,7,9 kW.

Resistance power: 4.5kW 1-phase or 3-phase 12,14,16 kW

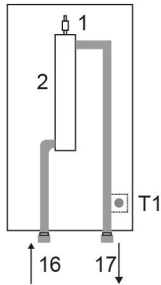

12 / 14 / 16 kW

Option

Installation inside the unit

Resistance power: 3kW - 4,5 kW 1-phase; 4,5 kW 3-phase

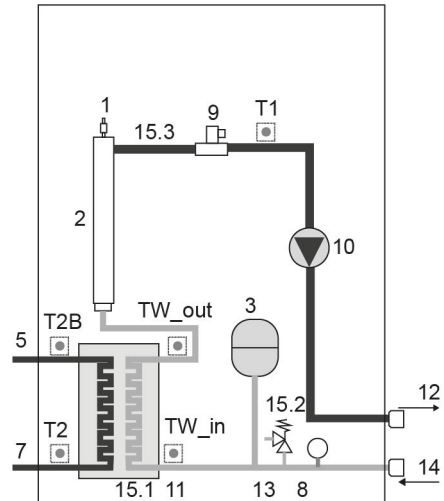

1	Air purge valve	12	Water outlet connection
2	Water vessel with backup heater(optional)	13	Pressure relief valve
3	Expansion vessel	14	Water inlet connection
5	Refrigerant gas connection	15.1	Electrical heating tape
7	Refrigerant liquid connection	15.2	Electrical heating tape
8	Manometer	15.3	Electrical heating tape
9	Flow switch	16	Water inlet connection
10	Circulation pump	17	Water outlet connection
11	Plate heat exchanger	Temperature sensors: TW_in TW_out T2B T2 T1(optional)	

NOTE

- The standard unit is without backup heater.
- Backup heater kit is an optional part for 5,7,9,12,14,16kW models.
- Backup heater can be integrated in the unit for customized models (12,14,16kW).
- If the backup heater is installed, the port (CN6) for T1 in the main control board of hydraulic compartment should connect to the corresponding port in the backup heater kit.

5 WATER CONNECTIONS

Hydraulic module

5 / 7 / 9 kW

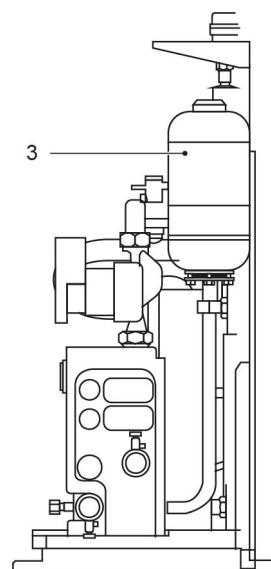
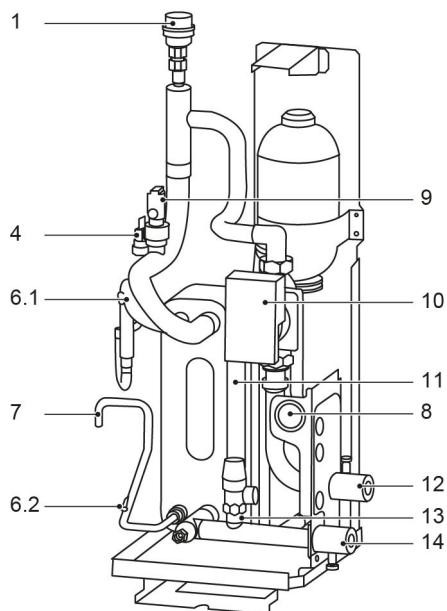

12 / 14 / 16 kW

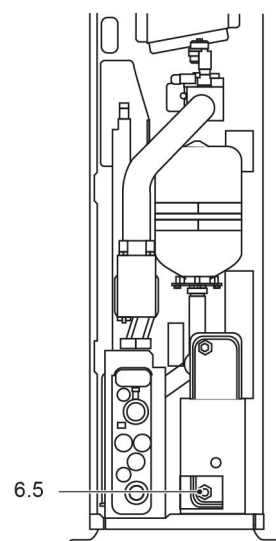
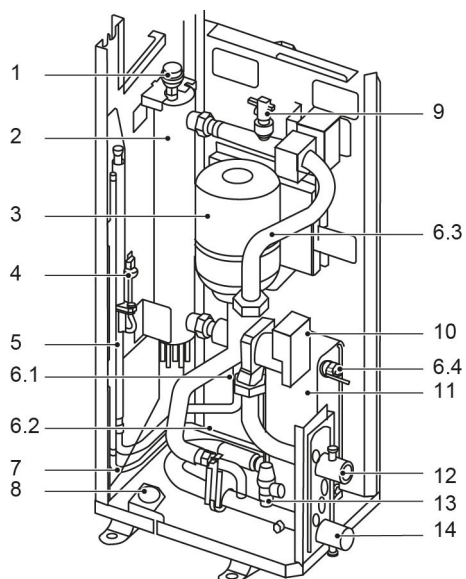

1	Air purge valve	Remaining air in the water circuit will be automatically removed from the water circuit.
2	Backup heater(optional)	Provides additional heating capacity when the heating capacity of the heat pump is insufficient due to very low outdoor temperature. Also protects the external water piping from freezing.
3	Expansion vessel	Balances water system pressure. (Expansion vessel volume: 2L in 5/7/9kW units and 5L in 12/14/16kW units.)
4	Pressure Sensor	/
5	Refrigerant gas connection	/
6	Temperature sensors	Four temperature sensors determine the water and refrigerant temperature at various points in the water circuit. 6.1-T2B; 6.2-T2; 6.3-T1(optional); 6.4-TW_out; 6.5-TW_in
7	Refrigerant liquid connection	/
8	Manometer	Provides water circuit pressure readout.
9	Flow switch	Detects water flow rate to protect compressor and water pump in the event of insufficient water flow.
10	Pump	Circulates water in the water circuit.
11	Plate heat exchanger	Transfer heat from the refrigerant to the water.
12	Water outlet connection	/
13	Pressure relief valve	Prevents excessive water pressure by opening at 43.5 psi (3 bar) and discharging water from the water circuit.
14	Water inlet connection	/

Water piping

NOTE

If the installation is equipped with a domestic hot water tank (optional), please refer to the domestic hot water tank Installation And Owner's Manual. If there is no glycol (anti-freeze) in the system there is a power supply or pump failure, drain the system (as shown in the figure below).

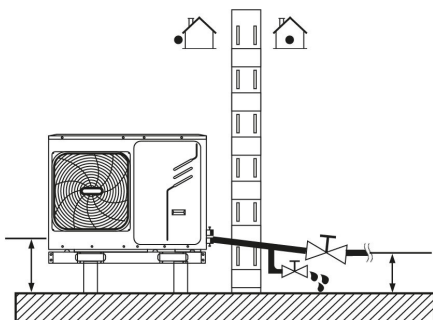

NOTE

If water is not removed from the system in freezing weather when unit is not used. The frozen water may damage the water circle parts.

Check the water circuit

The units are equipped with a water inlet and outlet for connection to a water circuit.
 The units should only be connected to closed water circuits.
 Connection to an open water circuit would lead to excessive corrosion of the water piping.
 Only materials complying with all applicable legislation should be used.

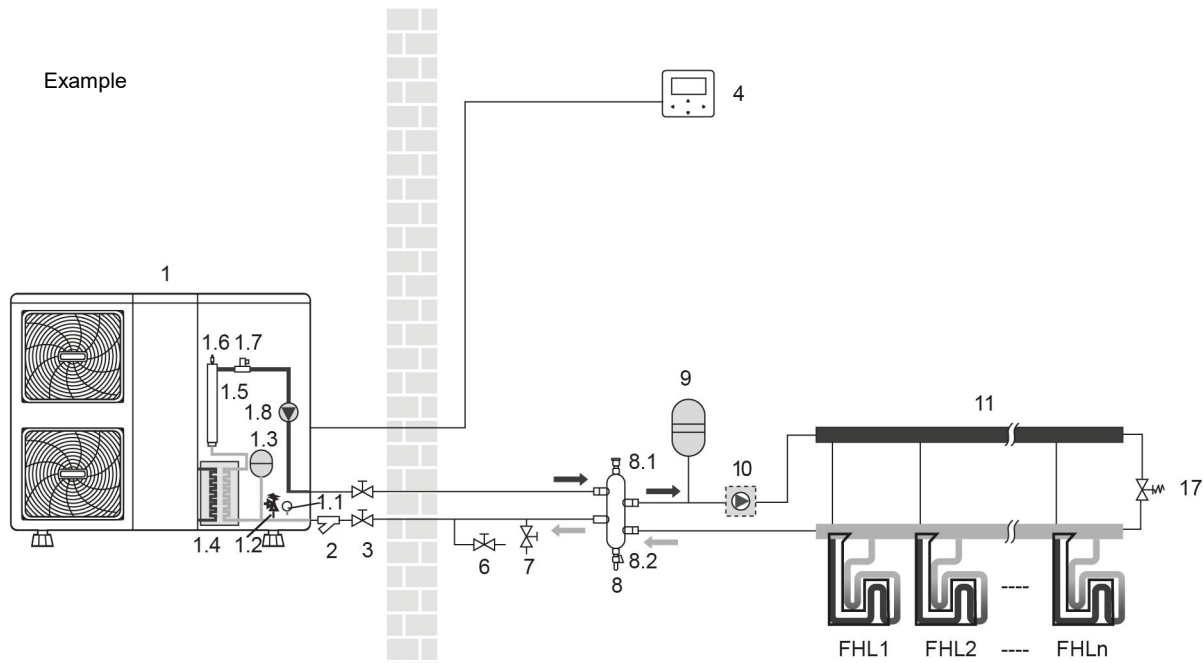

Before continuing installation of the unit, check the following:

- The maximum water pressure ≤ 3 bar.
- The maximum water temperature $\leq 70^{\circ}\text{C}$ according to safety device setting.
- Always use materials that are compatible with the water used in the system and with the materials used in the unit.
- Ensure that components installed in the field piping can withstand the water pressure and temperature.
- Drain taps must be provided at all low points of the system to permit complete drainage of the circuit during maintenance.
- Air vents must be provided at all high points of the system.
 The vents should be located at points that are easily accessible for service.
 An automatic air purge is provided inside the unit.
 Check that this air purge valve is not tightened so that automatic release of air in the water circuit is possible.

Water volume and expansion vessel pre-pressure checks

The units are equipped with an expansion vessel (5/7/9kW models:2L; 12/14/16kW models:5L) that has a default pre-pressure of 1.5 bar. To assure proper operation of the unit, the pre-pressure of the expansion vessel might need to be adjusted.

- 1) Check that the total water volume in the installation, excluding the internal water volume of the unit, is at least 25L (for 5/7/9 kW unit, the minimum volume is 15L) .
 Refer to 14 General technical data to find the total internal water volume of the unit.

NOTE

In most applications this minimum water volume will be satisfactory.
 In critical processes or in rooms with a high heat load though, extra water might be required.
 When circulation in each space heating loop is controlled by remotely controlled valves, it is important that this minimum water volume is kept even if all the valves are closed.

- 2) Using the table below, determine if the expansion vessel pre- pressure requires adjustment.
- 3) Using the table and instructions below, determine if the total water volume in the installation is below the maximum allowed water volume.

Installation height difference (a)	Water volume ≤72 L(b)	Water volume >72 L(b)
≤12 m	No pre-pressure adjustment required.	Calculate the volume of the expansion vessel based on the height of the system and its actual water content.
>12 m	Actions required: Pre-pressure must be increased, calculate according to "Calculating the pre-pressure of the expansion vessel" below.	Calculate the volume of the expansion vessel based on the height of the system and its actual water content.

- Height difference is between the highest point of the water circuit and the outdoor unit's expansion tank. Unless the unit is located at the highest point of the system, in which case the installation height difference is considered to be zero.
- For 1-phase 12~16kW and 3-phase 12~16kW units, this value is 72L, for 5~9kW units, this value is 30 L.

Calculating the pre-pressure of the expansion vessel

The pre-pressure (Pg) to be set depends on the maximum installation height difference (H) and is calculated as follows: $Pg(\text{bar}) = (H(\text{m})/10 + 0.3)$ bar

Checking the maximum allowed water volume

To determine the maximum allowed water volume in the entire circuit, proceed as follows:

- Determine the calculated pre-pressure (Pg) for the corresponding maximum water volume using the graph below.
- Check that the total water volume in the entire water circuit is lower than this value. If this is not the case, the expansion vessel inside the unit is too small for the installation.

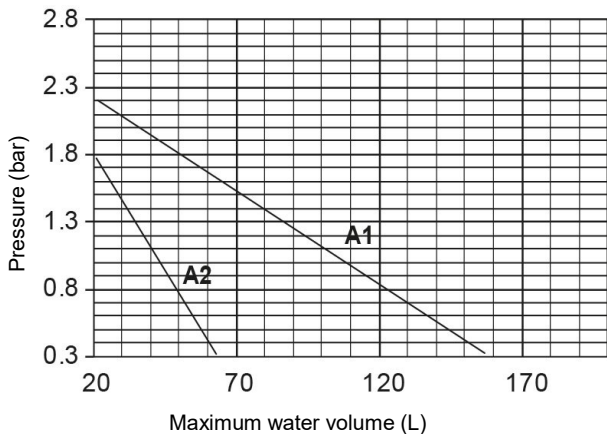

Pre-pressure = pre-pressure of the expansion vessel
 Maximum water volume = maximum water volume in the system
 A1 System without glycol for 1-phase 12~16 kW and 3-phase 12~16 kW unit
 A2 System without glycol for the 5/7/9 kW unit

5 WATER CONNECTIONS

Example 1 :

The unit (16kW) is installed 10m below the highest point in the water circuit. The total water volume in the water circuit is 50 L. In this example, no action or adjustment is required.

Example 2 :

The unit(16kW) is installed at the highest point in the water circuit. The total water volume in the water circuit is 150 L.

Result:

1. Since 150 L is more than 72 L, the pre-pressure must be decreased (see table above).
 - The required pre-pressure is: $P_g(\text{bar}) = (H(\text{m})/10+0.3) \text{ bar} = (0/10+0.3) \text{ bar} = 0.3 \text{ bar}$
 - The corresponding maximum water volume can be read from the graph: approximately 160 L.
 - Since the total water volume (150 L) is below the maximum water volume (160 L), the expansion vessel suffices for the installation.

Setting the pre-pressure of the expansion vessel

When it is required to change the default pre-pressure of the expansion vessel (1.5 bar), following guidelines:

- Use only dry nitrogen to set the expansion vessel pre-pressure.
- Inappropriate setting of the expansion vessel pre-pressure will lead to malfunctioning of the system. Pre-pressure should only be adjusted by a licensed installer.

Selecting the additional expansion vessel

If the expansion vessel of the unit is too small for the installation, an additional expansion vessel is needed.

- calculate the pre-pressure of the expansion vessel:

$$P_g(\text{bar})=(H(\text{m})/10+0.3) \text{ bar}$$

the expansion vessel equipped in the unit should adjust the pre- pressure also.

- calculate the volume needed of the additional expansion vessel:

$$V1=0.0693*V_{\text{water}}/(2.5-P_g)-V0$$

V_{water} is volume of water in the system, $V0$ is volume of expansion vessel which the unit is equipped(10~16kW, $V0=5\text{L}$, 5~9kW, $V0=2\text{L}$).

CAUTION

Be careful not to deform the unit's piping by using excessive force when connecting the piping.

Deforming the piping can cause the unit to malfunction.

If air, moisture or dust gets in the water circuit, problems may occur. Therefore, always take into account the following when connecting the water circuit:

- Use clean pipes only.
- Hold the pipe end downwards when removing burrs.
- Cover the pipe end when inserting it through a wall to prevent dust and dirt entering.
- Use a good thread sealant for sealing the connections. The sealing must be able to withstand the pressures and temperatures of the system.
- When using non-copper metallic piping, be sure to insulate two kind of materials from each other to prevent galvanic corrosion.
- For copper is a soft material, use appropriate tools for connecting the water circuit. Inappropriate tools will cause damage to the pipes.

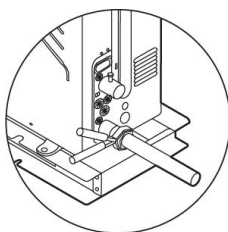

NOTE

The unit is only to be used in a closed water system. Application in an open water circuit can lead to excessive corrosion of the water piping:

- Never use Zn-coated parts in the water circuit. Excessive corrosion of these parts may occur as copper piping is used in the unit's internal water circuit.
- When using a 3-way valve in the water circuit. Preferably choose a ball type 3-way valve to guarantee full separation between the domestic hot water and floor heating water circuit.
- When using a 3-way valve or a 2-way valve in the water circuit. The recommended maximum changeover time of the valve should be less than 60 seconds.

Water circuit anti-freeze protection

Ice formation can cause damage to the hydraulic system. As the outdoor unit may be exposed to sub-zero temperatures, care must be taken to prevent freezing of the system.

All internal hydronic parts are insulated to reduce heat loss. Insulation must also be added to the field piping.

- The software contains special functions using the heat pump to protect the entire system against freezing. When the temperature of the water flow in the system drops to a certain value, the unit will heat the water, either using the heat pump, the electric heating tap, or the backup heater. The freeze protection function will turn off only when the temperature increases to a certain value.

In event of a power failure, the above features would not protect the unit from freezing.

Since a power failure could happen when the unit is unattended, the recommends use anti-freeze fluid to the water system.

Depending on the expected lowest outdoor temperature, make sure the water system is filled with a concentration of glycol as mentioned in the table below.

When glycol is added to the system, the performance of the unit will be affected.

The correction factor of the unit capacity, flow rate and pressure drop of the system is listed in the table below.

Ethylene Glycol

Quality of glycol/%	Modification coefficient				Freezing point/°C
	Cooling capacity modification	Power modification	Water resistance	Water flow modification	
0	1.000	1.000	1.000	1.000	0
10	0.984	0.998	1.118	1.019	-5
20	0.973	0.995	1.268	1.051	-15
30	0.965	0.992	1.482	1.092	-25

5 WATER CONNECTIONS

Propylene Glycol

Quality of glycol/%	Modification coefficient				Freezing point/°C
	Cooling capacity modification	Power modification	Water resistance	Water flow modification	
0	1.000	1.000	1.000	1.000	0
10	0.976	0.996	1.071	1.000	-4
20	0.961	0.992	1.189	1.016	-12
30	0.948	0.988	1.380	1.034	-20

If no glycol is added, the water must be drained out when there is a power failure.

Water may enter into the flow switch and cannot be drained out and may freeze when the temperature is low enough.

The flow switch should be removed and dried, then can be reinstalled in the unit.

WARNING

Ethylene Glycol and Propylene Glycol are TOXIC

The concentrations mentioned in the table above will not prevent freezing, but will prevent the hydraulics from bursting.

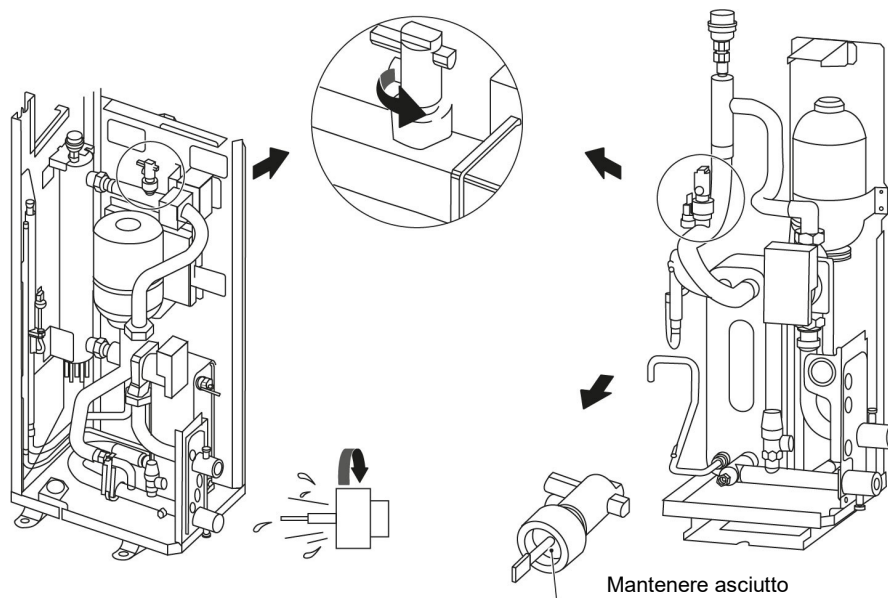

NOTE

Counterclockwise rotation, remove the flow switch.

Drying the flow switch completely.

CAUTION

Use of glycol

Glycol use for installations with a domestic hot water tank: Only propylene glycol having a toxicity rating or class of 1, as listed in "Clinical Toxicology of Commercial Products, 5th edition" may be used. The maximum allowed water volume is then reduced according to the figure on page 45.

If there is too much pressure when using glycol, connect the safety valve to a drain pan to recover the glycol.

NOTE

Be aware of the hygroscopic property of glycol. It absorbs moisture from the environment.

Leaving the cap off the glycol container causes the concentration of water to increase. The glycol concentration is then lower and the water could freeze.

Preventive actions must be taken to ensure minimal exposure of the glycol to air.

Corrosion in the system due to glycol

Uninhibited glycol will turn acidic under the influence of oxygen. This process is accelerated by presence of copper and at higher temperatures. The acidic uninhibited glycol attacks metal surfaces and forms galvanic corrosion cells that cause severe damage to the system.

- It is of extreme importance:
- That the water treatment is correctly executed by a qualified water specialist.
- That a glycol with corrosion inhibitors is selected to counteract acids formed by the oxidation of glycols.
- That in case of an installation with a domestic hot water tank, only the use of propylene glycol is allowed. In other installations the use of ethylene glycol is fine.
- That no automotive glycol is used because their corrosion inhibitors have a limited lifetime and contain silicates that can foul or plug the system.
- That galvanized piping is not used in glycol systems since it may lead to the precipitation of certain elements in the glycol's corrosion inhibitor.
- To ensure that the glycol is compatible with the materials used in the system.

Adding water

- Connect the water supply to the fill valve and open the valve.
- Make sure the automatic air purge valve is open (at least 2 turns).
- Fill with water until the manometer indicates a pressure of approximately 2.0 bar. Remove air in the circuit as much as possible using the air purge valves. Air in the water circuit could lead to malfunction of the backup electric heater.

Do not fasten the black plastic cover on the vent valve at the top side of the unit when the system is running.
Open air purge valve, turn anticlockwise at least 2 full turns to release air from the system.

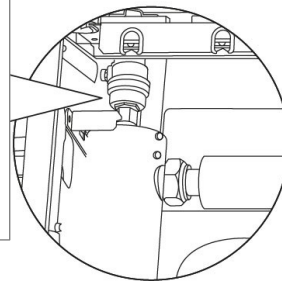

NOTE

During filling, it might not be possible to remove all air in the system.

Remaining air will be removed through the automatic air purge valves during the first operating hours of the system.

Topping up the water afterwards might be required.

The water pressure indicated on the manometer will vary depending on the water temperature (higher pressure at higher water temperature).

However, at all times water pressure should remain above 0.3 bar to avoid air entering the circuit.

The unit might drain-off too much water through the pressure relief valve.

Water quality must be according to "Safe Drinking water Act".

Piping insulation

The complete water circuit including all piping, must be insulated to prevent:

- condensation during cooling operation
- reduction of the heating and cooling capacity
- freezing of the outside water piping during winter.

The thickness of the sealing materials must be at least 13 mm with $\lambda = 0.039$ W/mK in order to prevent freezing on the outside water piping.

If the temperature is higher than 30°C and the humidity is higher than RH 80%, then the thickness of the sealing materials should be at least 20 mm in order to avoid condensation on the surface of the seal.

6 ELECTRICAL CONNECTIONS

WARNING

A main switch or other means of disconnection, having a contact separation in all poles, must be incorporated in the fixed wiring in accordance with relevant local laws and regulations.

Switch off the power supply before making any connections.

Use only copper wires. Never squeeze bundled cables and make sure they do not come in contact with the piping and sharp edges. Make sure no external pressure is applied to the terminal connections.

All field wiring and components must be installed by a licensed electrician and must comply with relevant local laws and regulations.

The field wiring must be carried out in accordance with the wiring diagram supplied with the unit and the instructions given below.

Be sure to use a dedicated power supply.

Never use a power supply shared by another appliance.

Be sure to establish a ground.

Do not ground the unit to a utility pipe, surge protector, or telephone ground. Incomplete grounding may cause electrical shock.

Be sure to install a ground fault circuit interrupter (30 mA).

Failure to do so may cause electrical shock.

Be sure to install the required fuses or circuit breakers.

Precautions on electrical wiring work

- Fix cables so that cables do not make contact with the pipes (especially on the high pressure side).
- Secure the electrical wiring with cable ties as shown in figure so that it does not come in contact with the piping, particularly on the high-pressure side.
- Make sure no external pressure is applied to the terminal connectors.
- When installing the ground fault circuit interrupter make sure that it is compatible with the inverter (resistant to high frequency electrical noise) to avoid unnecessary opening of the ground fault circuit interrupter.

NOTE

The ground fault circuit interrupter must be a high- speed type breaker of 30 mA (<0.1 s).

This unit is equipped with an inverter.

Installing a phase advancing capacitor not only will reduce the power factor improvement effect, but also may cause abnormal heating of the capacitor due to high-frequency waves. Never install a phase advancing capacitor as it could lead to an accident.

Overview

The illustration below gives an overview of the required field wiring between several parts of the installation. Refer also to " Typical application examples".

A	Outdoor unit	I	P_d: DHW pump (not supplied)
B	Solar energy kit (not supplied)	J	SV2: 2-way valve (not supplied)
C	User interface	K	SV1: 3-way valve for domestic hot water tank (not supplied)
D	Room thermostat (not supplied)	L	Domestic hot water tank
E	Boiler (not supplied)	M	Booster heater
F	P_s: Solar pump (not supplied)	N	Contactora
G	P_c: Mixing pump (not supplied)	O	Power supply
H	P_o: Outside circulation pump (not supplied)	P	Backup heater
		Q	SV3: zone 2 3-way valve (not supplied)

N.	Description	AC/DC	N. conductors	Maximum running current
1	Solar energy kit signal cable	AC	2	200mA
2	User interface cable	AC	5	200mA
3	Room thermostat cable	AC	2 or 3	200mA(a)
4	Boiler control cable	/	2	200mA
5	Thermistor cable for T1B	DC	2	(b)
9	DHW pump control cable	AC	2	200mA(a)
10	2-way valve control cable	AC	2	200mA(a)
11	3-way valve control cable	AC	2 or 3	200mA
12	Thermistor cable	DC	2	(b)
13	Booster heater control cable	AC	2	200mA(a)
15	Power supply cable for unit	AC	2+GND(1-Phase)	31A (1-Phase)
16	Power supply cable for backup heater	AC	2+GND(1-Phase)	14A (1-Phase)

(a) Minimum cable section AWG18 (0.75 mm²)

(b) The thermistor and connection wire (10m) are delivered with the domestic hot water tank (T5) or zone 2 outlet temperature (T1B)

NOTE

Please use H07RN-F for the power wire, all the cable are connect to high voltage except for thermistor cable and cable for user interface.

Equipment must be grounded.

All high-voltage external load, if it is metal or a grounded port, must be grounded.

All external load current is needed less than 0.2A, if the single load current is greater than 0.2A, the load must be controlled through AC contactor.

AHS1" "AHS2", "A1" "A2", "R1" "R1" and "DTF1" "DTF2" wiring terminal ports provide only the switch signal.

Please refer to page 59 of connection terminal block to get the ports position in the unit.

Expansion valve E-Heating tape, Plate heat exchanger E-Heating tape and Flow switch E-Heating tape share a control port.

6 ELECTRICAL CONNECTIONS

Electronic control box

5 / 7 / 9 kW

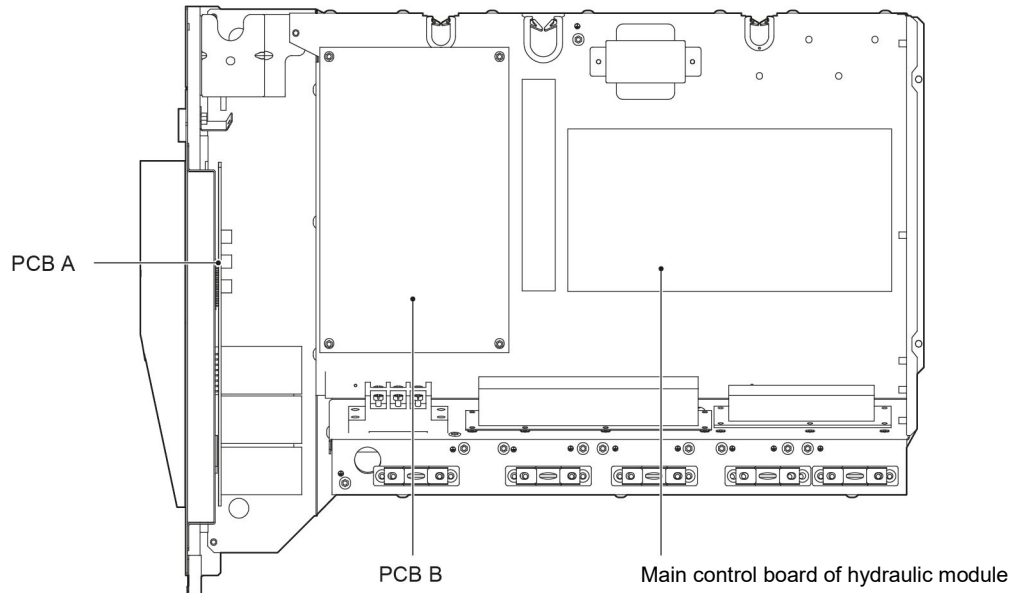

12 / 14 / 16 kW

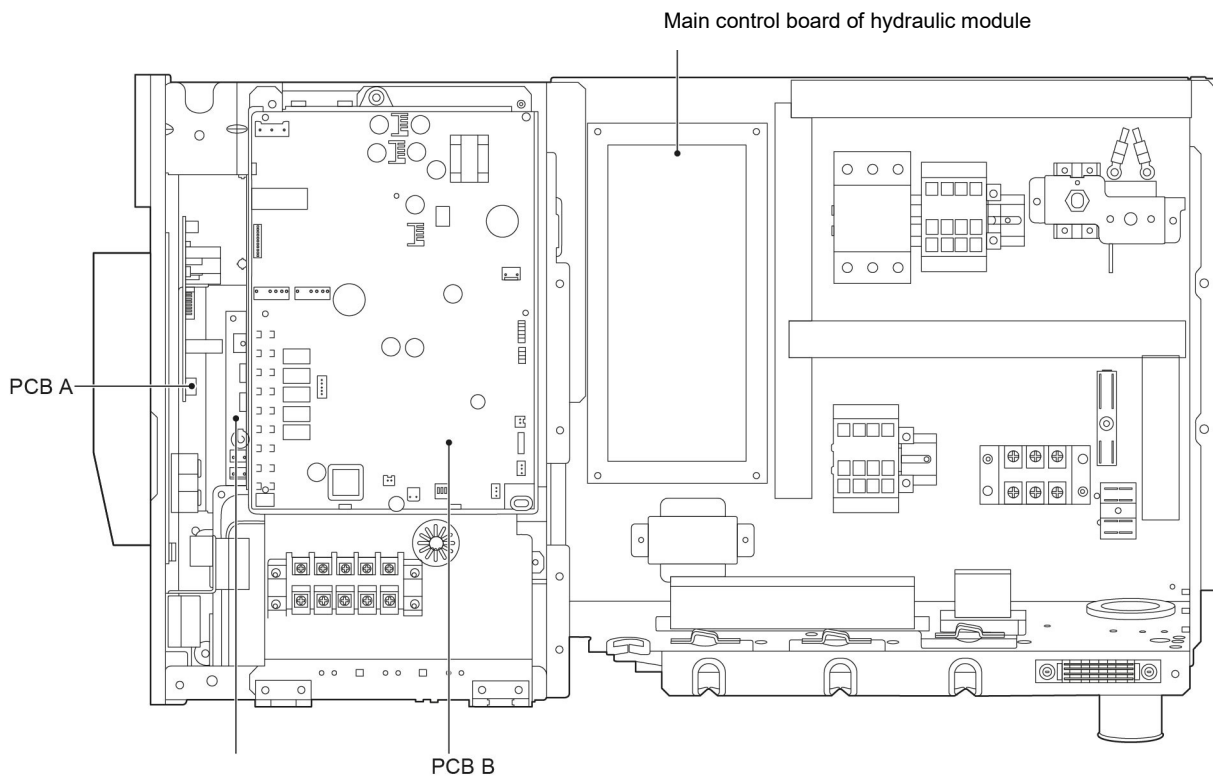

PCB C (at back of the PCB B, only for 3 phase unit)

The picture is for reference only

1-phase 12~16kW
3-phase 12~16kW

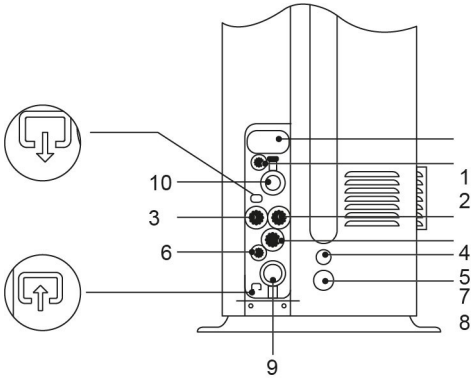

1	High voltage wire hole
2	Low voltage wire hole
3	High voltage wire hole
4	Compressor connection port W
5	Drainage pipe hole
6	Low voltage wire hole
7	Low voltage wire hole(backup)
8	Low voltage wire hole(backup)
9	Water inlet
10	Water outlet

1-phase 5/7/9 kW

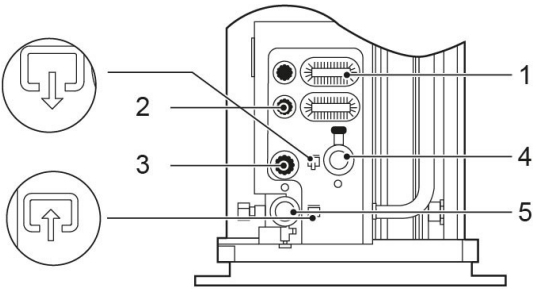

1	High voltage wire hole
2	Low voltage wire hole
3	Drainage pipe hole
4	Water outlet
5	Water inlet

Field wiring guidelines

- Most field wiring on the unit is to be made on the terminal block inside the switch box. To gain access to the terminal block, remove the switch box service panel (door 2).

WARNING

Switch off all power including the unit power supply and backup heater and domestic hot water tank power supply (if applicable) before removing the switch box service panel.

- Fix all cables using cable ties.
- A dedicated power circuit is required for the backup heater.
- Installations equipped with a domestic hot water tank (field supply) require a dedicated power circuit for the booster heater. Please refer to the domestic hot water tank Installation & Owner's Manual. Secure the wiring in the order shown below.
- Lay out the electrical wiring so that the front cover does not rise up when doing wiring work and attach the front cover securely.
- Follow the electric wiring diagram for electrical wiring works (the electric wiring diagrams are located on the rear side of door 2).
- Install the wires and fix the cover firmly so that the cover may be fit in properly.

Precautions on wiring of power supply

- Use a round crimp-style terminal for connection to the power supply terminal board. In case it cannot be used due to unavoidable reasons, be sure to observe the following instructions.
- Do not connect different gauge wires to the same power supply terminal. (Loose connections may cause overheating.)
- When connecting wires of the same gauge, connect them according to the figure below.

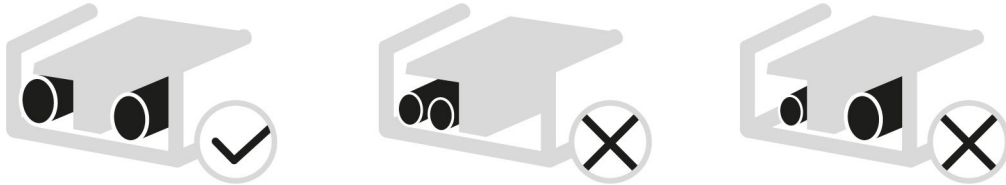

- Use the correct screwdriver to tighten the terminal screws. Small screwdrivers can damage the screw head and prevent appropriate tightening.
- Over-tightening the terminal screws can damage the screws.
- Attach a ground fault circuit interrupter and fuse to the power supply line.
- In wiring, make certain that prescribed wires are used, carry out complete connections, and fix the wires so that outside force cannot affect the terminals.

Specifications of standard wiring components

Door 1: compressor compartment and electrical parts: XT1

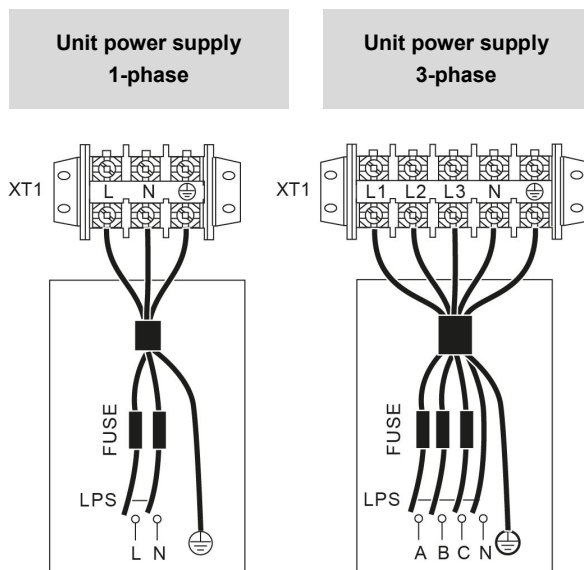

Unit (kW)	1-phase		3-phase
	5/7/9	12~16	12~16
Maximum overcurrent protector (MOP)	20	30	15
Wiring size (mm ²)	4	6	4

Stated values are maximum values (see electrical data for exact values).

NOTE

The ground fault circuit interrupter must be a high-speed type breaker of 30 mA (<0.1 s).

Connection of the backup heater power supply

Only for models that contain backup heater.
Power circuit and cable requirements

CAUTION

Be sure to use a dedicated power circuit for the backup heater.
Never use a power circuit shared by another appliance.
Use the same dedicated power supply for the unit, backup heater and booster heater (domestic hot water tank).

This power circuit must be protected with the required safety devices according to local laws and regulations.
Select the power cable in accordance with relevant local laws and regulations.
For the maximum running current of the backup heater, refer to the table below.

Door 2: electrical parts of the hydraulic compartment, backup heater: XT5 (3-phase) /XT4(1-phase)

Power supply for electrical heater

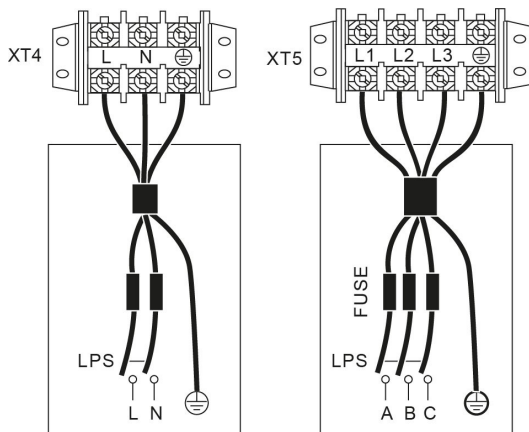

Unit(kW)	Backup heater capacity	
	1-phase	3-phase
	3	4.5
Backup heater nominal voltage	220-240VAC	380-415VAC
Minimum circuit amps (MCA)	14.3	6.0
Maximum overcurrent protector(MOP)	20	10
Wiring size(mm ²)	3.3	2.1

NOTE

The ground fault circuit interrupter must be a high-speed type breaker of 30 mA (<0.1 s).

6 ELECTRICAL CONNECTIONS

Connection terminal block

Unit 5 / 7 / 9 kW

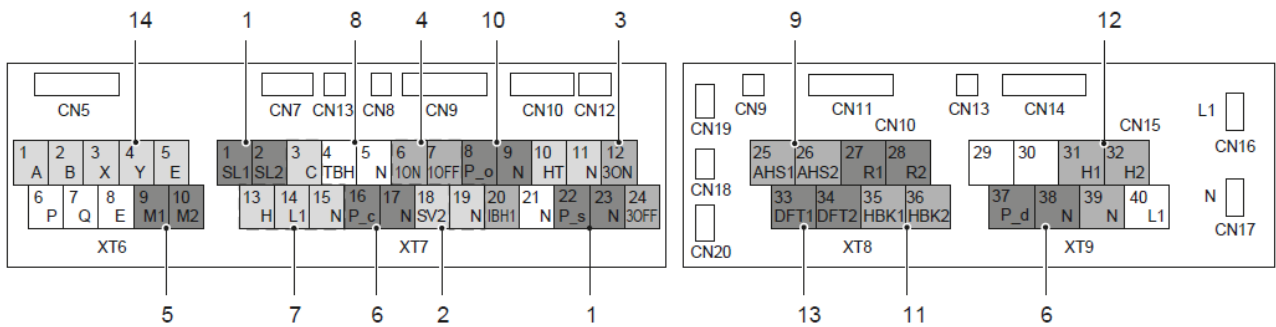

Unit 12 / 14 / 16 kW

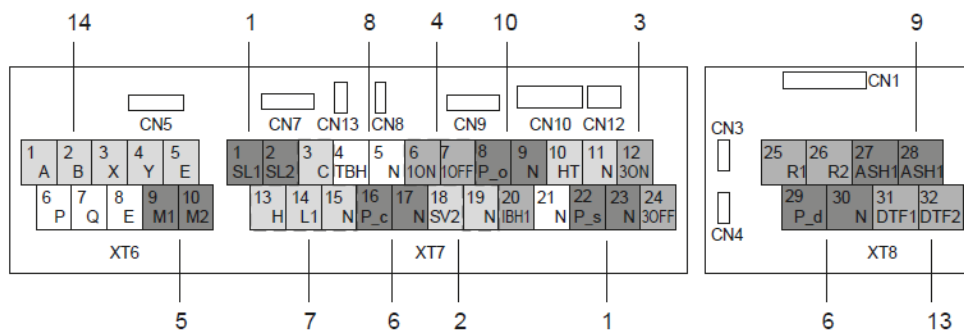

1	Solar input / Pump_S	8	DHW electric back heating
2	SV2	9	Additional heat source
3	SV3 (3-way zone 2)	10	Pump_O
4	SV1 (3-way)	11	Feedback switch signal input
5	Remote shut down	12	External backup heater kit
6	Pump_C / Pump_D	13	Defrosting prompt signal
7	Room thermostat	14	Wired Controller

Port provide the control signal to the load. Two kind of control signal port:

Type 1 : Dry connector without voltage.

Type 2 : Port provide the signal with 220V voltage. If the current of load is <0.2A, load can connect to the port directly.

If the current of load is $\geq 0.2A$, the AC connector is required to be connected for the load.

WIRING: transfer board/13 to 40 connection priority.

Type 1

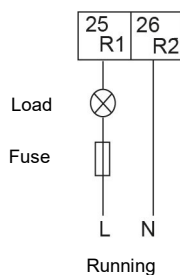

Type 2

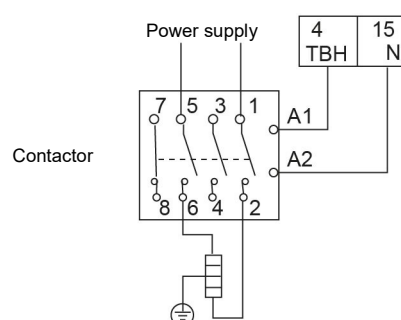

Procedure

- Connect the cable to the appropriate terminals as shown in the picture.
- Fix the cable with cable ties to the cable tie mountings to ensure stress relief.

Remote shut down:

Unit ON Unit OFF

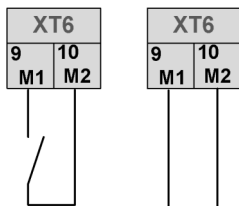

DHW - 3-way value SV1

SV1 3 wire

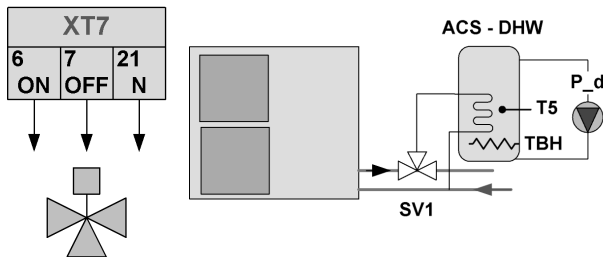

Voltage	220-240VAC
Maximum running current(A)	0.2
Wiring size(mm ²)	0.75
Control port signal type	Type 2

NOTE

Wiring of the 3-way valve is different for NC (normal close) and NO (normal open).
Before wiring, read the Installation & Owner's manual for the 3-way valve carefully and install the valve as showed in the picture.
Make sure to connect it to the correct terminal numbers.

DHW - Tank booster heater

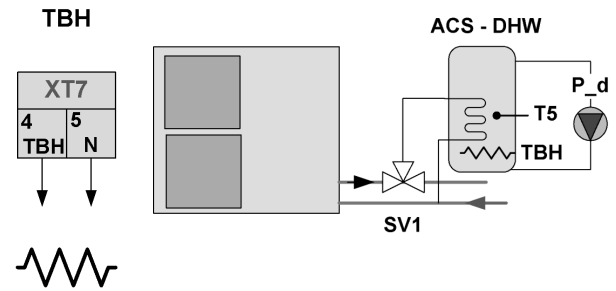

TBH tank booster heater

Voltage	220-240VAC
Maximum running current(A)	0.2
Wiring size(mm ²)	0.75
Control port signal type	Tipo 2

Connection of the booster heater cable depends on the application.

Only when the domestic hot water tank is installed will this wiring be needed.

The unit only sends a turn on/off signal to the booster heater.

An additional circuit breaker is needed and a dedicated terminal is needed to supply power to the booster heater.

See also "8 Typical application examples" and see chapter Start-up and configuration.

DHW - Tank loop pump P_d

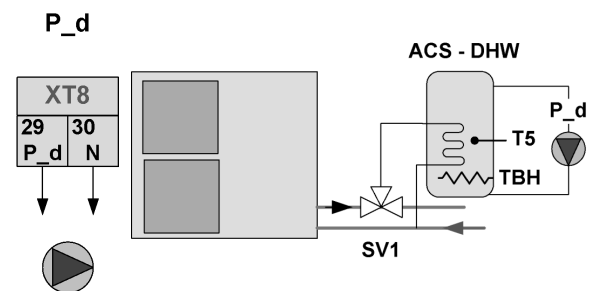

NOTE

For 5/7/9 kW unit, the terminal number is **37 and 38**.

Voltage	220-240VAC
Maximum running current(A)	0.2
Wiring size(mm ²)	0.75
Control port signal type	Type 2

6 ELECTRICAL CONNECTIONS

Outside circulation pump P_o

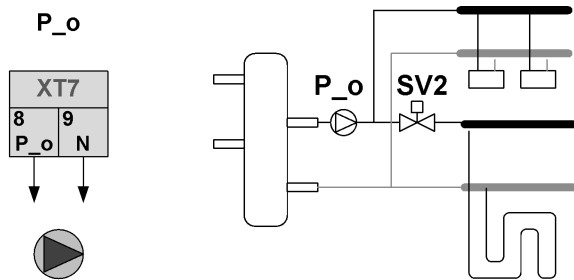

Voltage	220-240VAC
Maximum running current(A)	0.2
Wiring size(mm ²)	0.75
Control port signal type	Type 2

2-way valve SV2

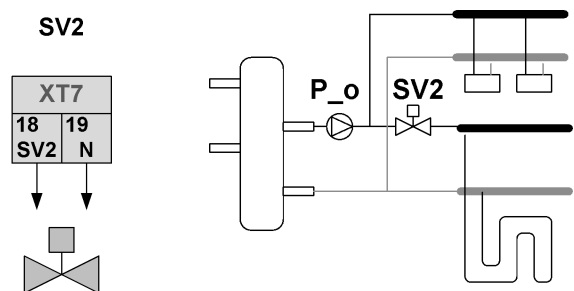

Voltage	220-240VAC
Maximum running current(A)	0.2
Wiring size(mm ²)	0.75
Control port signal type	Type 2

NOTE

Only a normal closing valve is available for this unit

Mix pump P_c

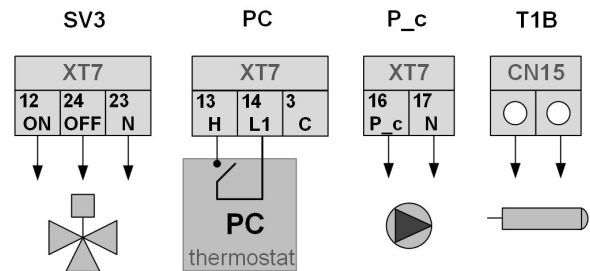
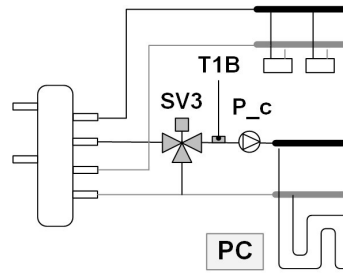

Voltage	220-240VAC
Maximum running current(A)	0.2
Wiring size(mm ²)	0.75
Control port signal type	Type 2

Defrosting prompt signal

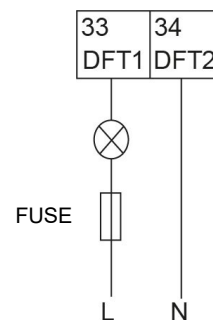

Voltage	220-240VAC
Maximum running current(A)	0.2
Wiring size(mm ²)	0.75
Control port signal type	Type 1

Backup heater kit

optional

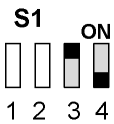
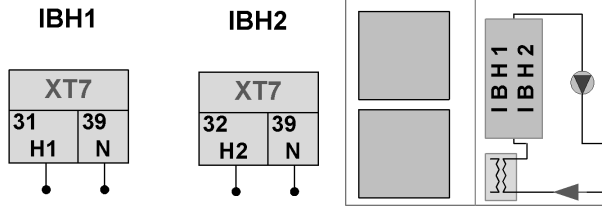

Additional heat source

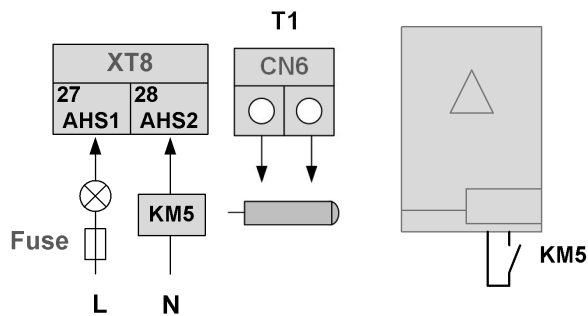

NOTE

For 5/7/9 kW unit, the terminal number is 25 and 26

Voltage	220-240VAC
Maximum running current(A)	0.2
Wiring size(mm ²)	0.75
Control port signal type	Type 2

HEATING mode

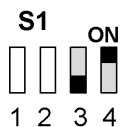

HEATING + DWH mode



Solar kit

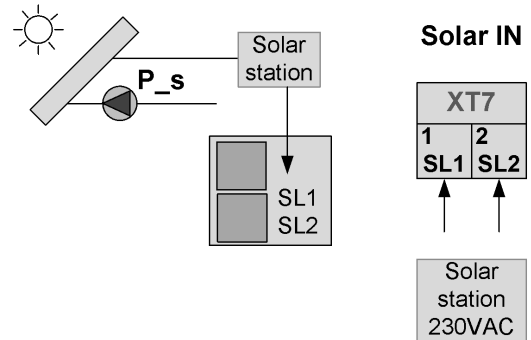

Voltage	220-240VAC
Maximum running current(A)	0.2
Wiring size(mm ²)	0.75

P_s

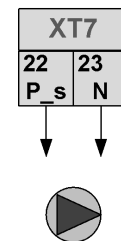

Voltage	220-240VAC
Maximum running current(A)	0.2
Wiring size(mm ²)	0.75
Control port signal type	Type 2

6 ELECTRICAL CONNECTIONS

User interface

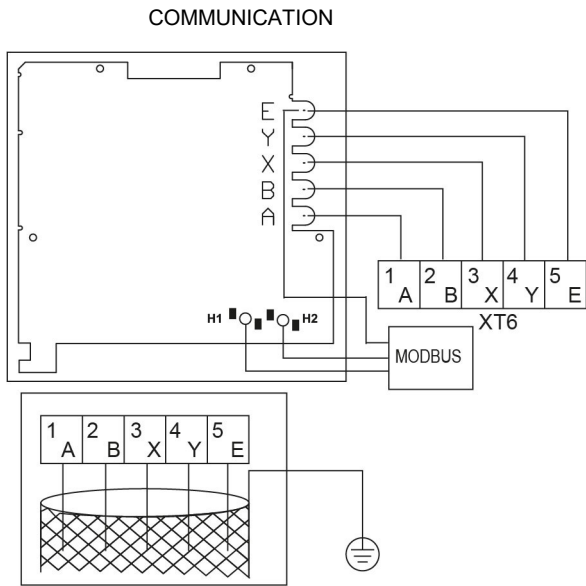

NOTE

Use shielded wire and earth the wire.
This equipment supports MODBUS RTU communication protocol. - See ATTACHMENTS

Wire type	5 wire shielded cable
Wire section(mm ²)	0.75~1.25
Maximum wire length(m)	50
Input voltage (A/B)	13.5VAC

Installation

Do not install the unit in a place with much oil, steam, sulfide gas. Otherwise, the product may deform and fail.

- 2) Check that all the components listed below are present.
- 3) Circuit of Wired Remote Controller is low voltage circuit. Never connect it with a standard 220V/380V circuit or put it into a same Wiring Tube with the circuit.
- 4) The shielded cable must be connected stable to the ground, or transmission may fail.
- 5) Do not attempt to extend the shielded cable by cutting, if it is necessary, use Terminal Connection Block to connect.
- 6) After finishing connection, do not use Megger to have the insulation check for the signal wire

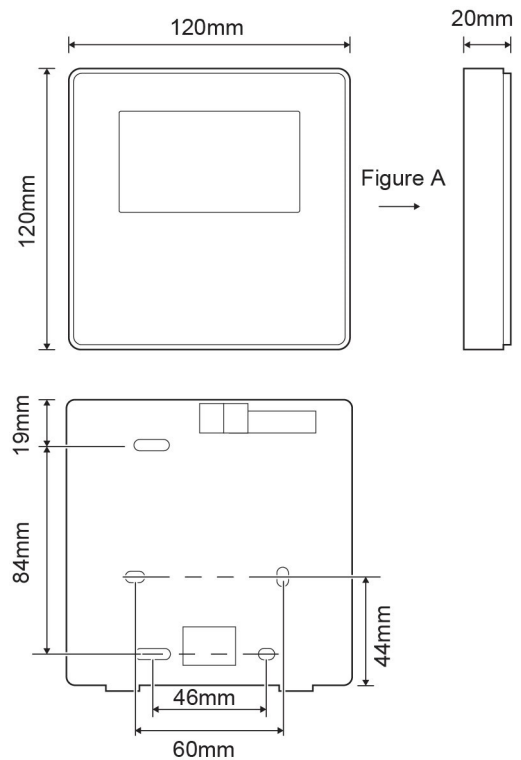

No.	Name	Qty.	Remarks
1	Wired Controller	1	
2	Cross round head wood mounting screw	3	For Mounting on the Wall
3	Cross round head mounting screw	2	For Mounting on the Electrical Switch Box
4	Installation and Owner's Manual	1	
5	Plastic bolt	2	This accessory is used when install the centralized control inside the electric cabinet
6	Plastic expansion pipe	3	For mounting on the Wall

Back cover installation

- 1) Use straight head screwdriver to insert in the buckling position in the bottom of wired controller, and spin the screwdriver to take down the back cover. (Pay attention to spinning direction, otherwise will damage the back cover!)
- 2) Use three M4X20 screws to directly install the back cover on the wall.
- 3) Use two M4X25 screws to install the back cover on the 86 electrician box, and use one M4X20 screws for fixing on the wall.
- 4) Adjust the length of two plastic screw bars in the accessory to be standard length from the electrical box screw bar to the wall. Make sure while installing the screw bar to the wall, making it as flat as the wall.
- 5) Use cross head screws to fix the wired controller bottom cover in the wall through the screw bar. Make sure the wired controller bottom cover is on the same level after installation, and then install the wired controller back to the bottom cover.
- 6) Over fastening the screw will lead to deformation of back cover.

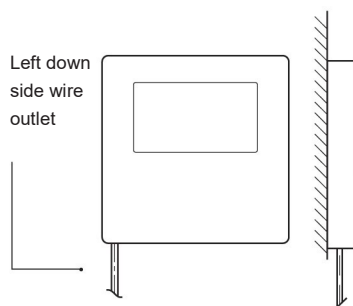
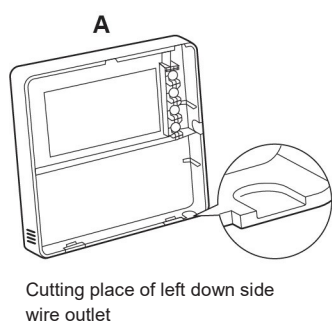

Wall installation

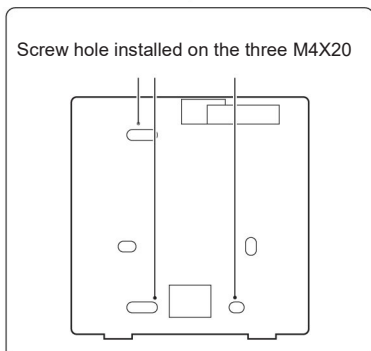
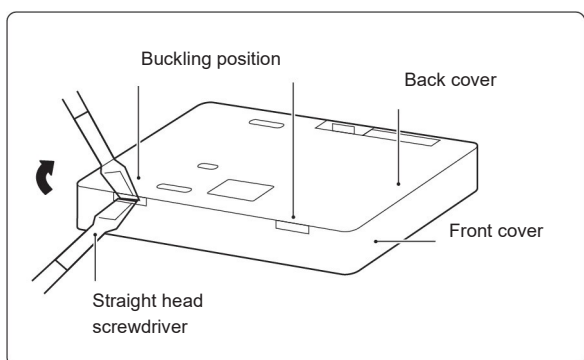

Installation in electrical box 86

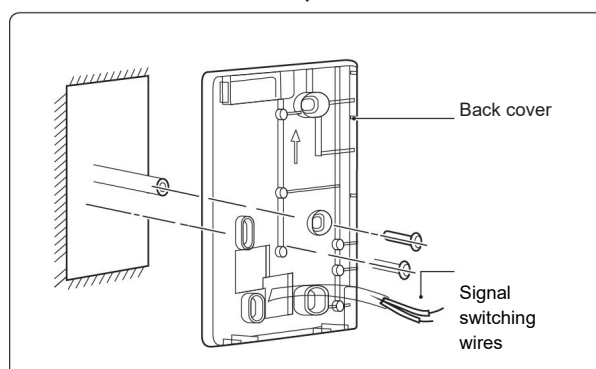
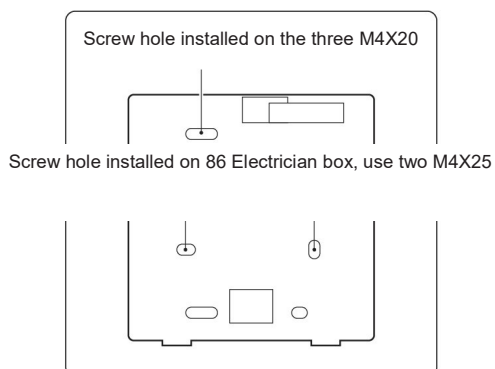

6 ELECTRICAL CONNECTIONS

Avoid the water enter into the wired remote controller, use trap and putty to seal the connectors of wires during wiring installation.

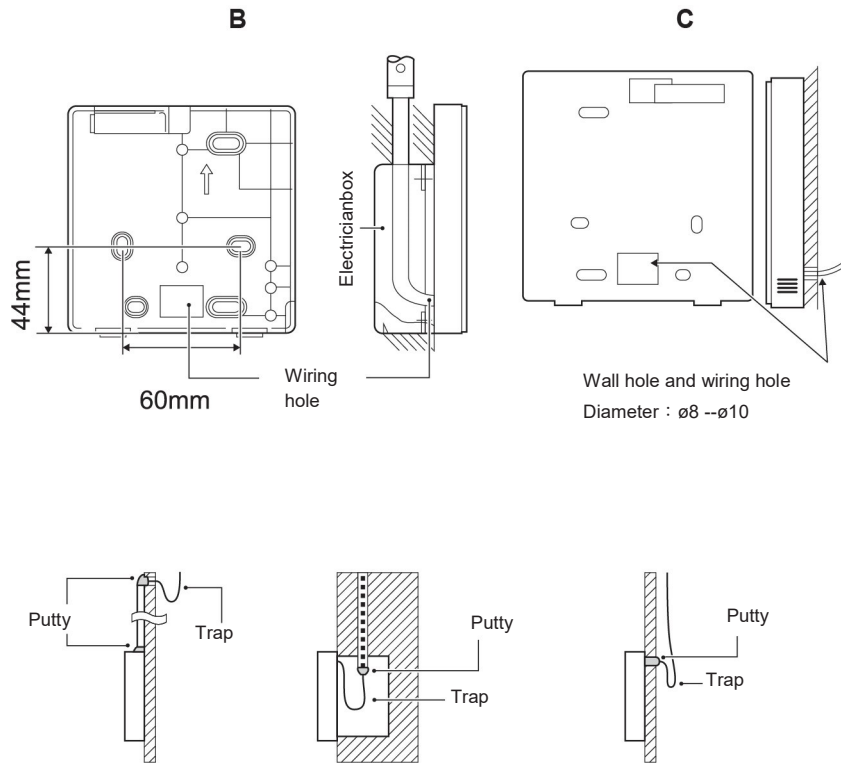

Front cover installation

After adjusting the front cover and then buckle the front cover; avoid clamping the communication switching wire during installation.

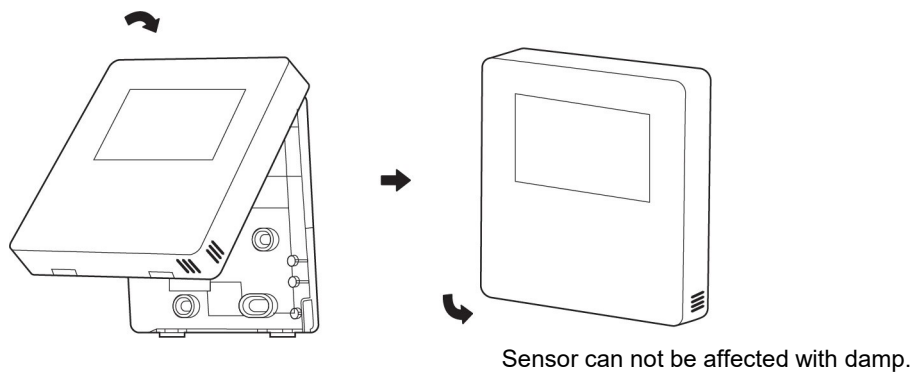

Correct install the back cover and firmly buckle the front cover and back cover, otherwise will make the front cover drop off.

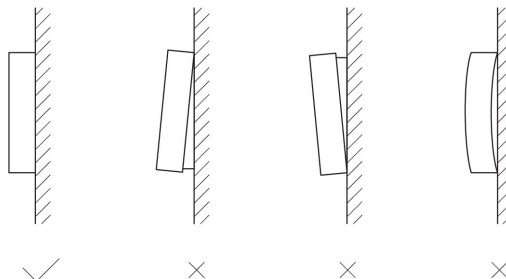

Room thermostat - Not supplied

There are three methods for connecting the thermostat cable and it depends on the application.

Method A

- On-Off + Heat from input H - L1
- On-Off + Cool from input C - L1

User interface setting:

ROOM THERMOSTAT and ROOM THERMOSTAT to MODE SET

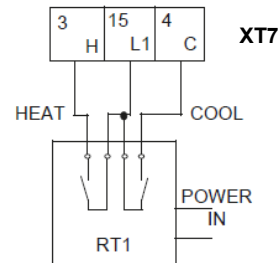

Method B

- On-Off from input H - L1
- Heat-Cool from user interface

User interface setting:

ROOM THERMOSTAT and ROOM THERMOSTAT to ONE ZONE,

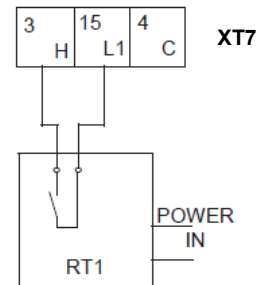

NOTE

When ROOM THERMOSTAT is set , the indoor temperature sensor Ta can't be set to valid, unit running only according to T1.

Method C

Hydraulic module is connected with two external temperature..

- On-Off zone 1 from input H - L1
- On-Off zone 1 from input C - L1
- Heat-Cool from user interface

User interface setting:

ROOM THERMOSTAT and ROOM THERMOSTAT to DOUBLE ZONE

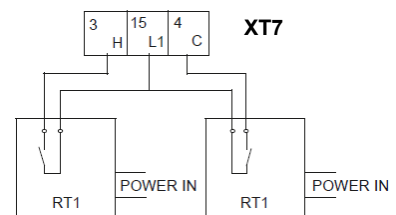

NOTE

The wiring of the thermostat should correspond to the settings of the user interface.

See chapter START-UP AND CONFIGURATION - ROOM THERMOSTAT.

Power supply of machine and room thermostat must be connected to the same Neutral Line and (L2) Phase Line(for 3-phase unit only).

7 START-UP AND CONFIGURATION

The unit should be configured by the installer to match the installation environment (outdoor climate, installed options, etc.) and user expertise.

CAUTION

It is important that all information in this chapter is read sequentially by the installer and that the system is configured as applicable.

Description of terms

The terms related to this unit are shown in the table below.

Parameter	Description
AHS	Additional heating source
DHW	Domestic hot water
IBH1	The first backup heater
IBH2	The second backup heater
Pe	Evaporate/condense pressure in cooling/ heating mode
T1	Water outlet temperature from the additional heat source (backup heater or boiler)
T1B	Mixed circuit temperature
T1S	Setpoint per la temperatura di uscita dell'acqua
T2	Temperature of refrigerant at let outlet /inlet of plate heat exchanger when in heating mode/ cooling mode
T2B	Temperature of refrigerant at let outlet /inlet of plate heat exchanger when in heating mode/ cooling mode
T3	Temperature of tube at outlet/inlet of condenser when in cooling/heating mode
T4	Ambient temperature
T5	Temperature of domestic hot water
Th	Suction temperature
Tp	Discharge temperature
TW_in	Inlet water temperature of plate heat exchanger
TW_out	Outlet water temperature of plate heat exchanger
TBH	Backup heater in the domestic hot water tank

Climate related curves

The Climate related curves can be selected in the user interface.

Once the curve is selected, the target outlet temperature. In each mode, user can select one curve from curves in the user interface (curve can't be selected if dual room thermostat function is enabled).

It's possible to select curves even dual room thermostat function is enabled. This function is for customized.

The relationship between outdoor temperature ($T4/^{\circ}\text{C}$) and the target water temperature ($T1S/^{\circ}\text{C}$) is described in the table and picture in the next page.)

NOTE

If dual room thermostat function is enabled, only curve 4 can be used, for customization product, curve selection is possible even dual room thermostat function is enabled.

Temperature curves for HEATING mode and ECO heating mode

Application	T1s Curve number	Outdoor Temperatures T4										
		-20	-15	-10	-5	0	5	10	15	20	25	30
Low temperature	1	38	37	36	36	35	34	33	33	32	32	32
	2	35	34	34	33	32	32	31	31	30	30	30
	3	33	33	32	32	31	31	31	30	30	30	30
	4	35	34	33	32	31	31	30	29	28	28	28
	5	33	32	32	31	30	30	29	29	28	28	28
	6	31	30	30	29	28	28	27	27	26	26	26
	7	29	29	28	28	27	27	27	26	26	26	26
	8	29	28	28	27	26	26	25	25	24	24	24
High temperature	1	55	54	54	53	52	52	51	51	50	50	50
	2	55	54	52	51	50	49	47	46	45	45	45
	3	55	53	51	49	47	45	44	42	40	40	40
	4	50	49	49	48	47	47	46	46	45	45	45
	5	50	49	47	46	45	44	42	41	40	40	40
	6	45	44	44	43	42	42	41	41	40	40	40
	7	45	44	42	41	40	39	37	36	35	35	35
	8	40	39	39	38	37	37	36	36	35	35	35

HEATING mode
Low temperature curves

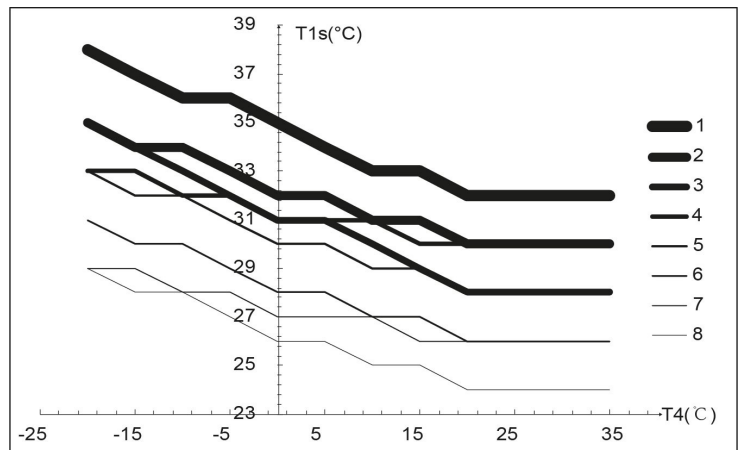

HEATING mode
High temperature curves

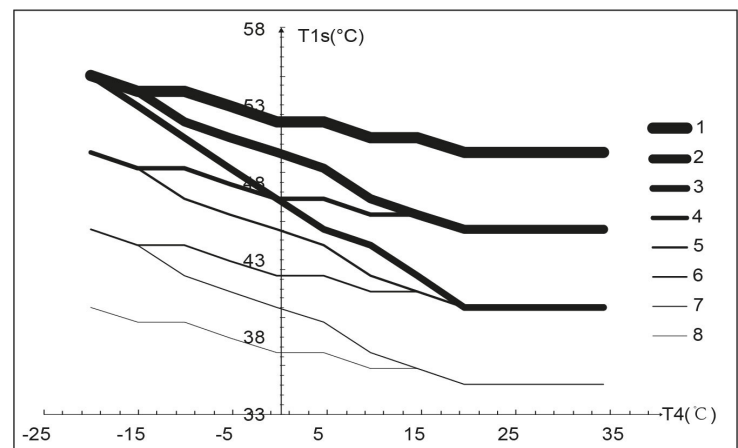

7 START-UP AND CONFIGURATION

Temperature curves for Cooling mode

Application	Curve number	Outdoor Temperatures T4			
		-5~ 14	15~ 21	22~ 29	30~ 46
Low temperature	1	18	11	8	5
	2	17	12	9	6
	3	18	13	10	7
	4	19	14	11	8
	5	20	15	12	9
	6	21	16	13	10
	7	22	17	14	11
	8	23	18	15	12
High temperature	1	22	20	18	16
	2	20	19	18	17
	3	23	21	19	17
	4	21	20	19	18
	5	24	22	20	18
	6	22	21	20	19
	7	25	23	21	19
	8	23	22	21	20

COOLING mode
Low temperature curves

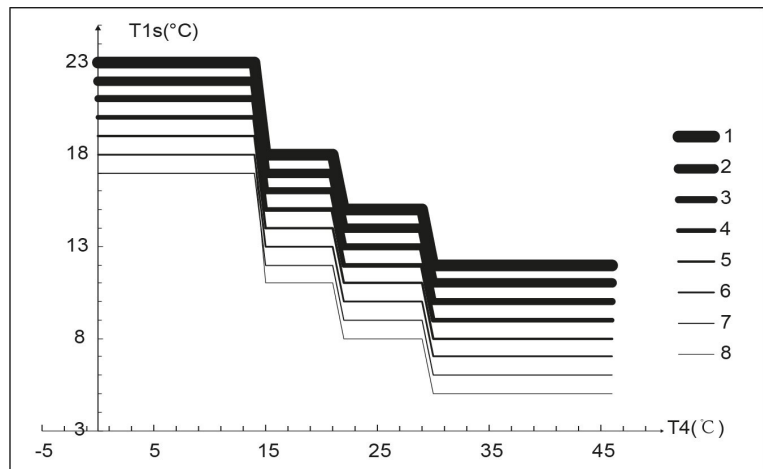

COOLING mode
High temperature curves

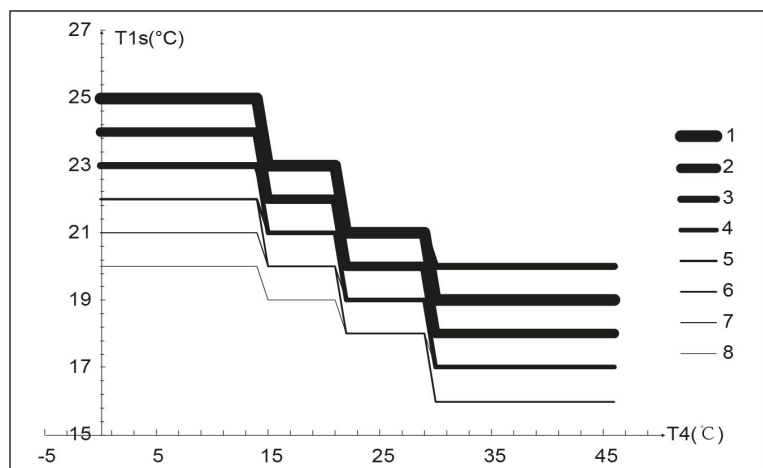

DIP switch settings overview - Function setting

DIP switch 13 is located on the hydraulic module main control board and allows configuration of additional heating source thermistor installation, the second inner backup heater installation, etc.

WARNING

Switch off the power supply before opening the switch box service panel and making any changes to the DIP switch settings.

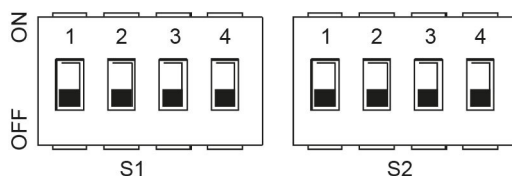

DIP switch		ON = 1	OFF = 0	Factory configuration
S1	1	Procedure = C	Procedure = M	ON
	2	Solar YES	Solar NO	OFF
	3 / 4	0/0 = IBH and AHS not present 0/1 = AHS present (heating mode) 1/0 = IBH present 1/1 = AHS present (heating and DHW)		3 = OFF 4 = OFF

AHS additional heating source

IBH external backup heater (optional)

DIP switch		ON = 1	OFF = 0	Factory configuration
S2	1	Pump P _o does NOT activate every 6 hours	Pump P _o activates every 6 hours	OFF
	2	TBH not present	TBH present	OFF
	3 / 4	0/0 = variable speed pump (max 8.5mt) 0/1 = fixed speed pump 1/0 = fixed speed pump (reserved) 1/1 = variable speed pump (max 9mt)		3 = OFF 4 = ON

TBH Storage tank electric heater

P_o external pump

Maximum operating current setting

DIP switch is located on the main board.







If the user configuration load is small, please select the dial code type according to the actual load.

This function is only for single-phase models (Three phase model this function reservation)

WARNING

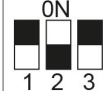
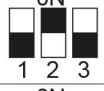
Switch off the power supply before opening the switch box service panel and making any changes to the DIP switch settings.

If you choose to reduce the maximum current operation, the machine effect will be affected by different levels.

DIP switch	5/7/9kW (1-phase) SW3	12/14/16kW (1-phase) SW4	DIP switch	5/7/9kW (1-phase) SW3	12/14/16kW (1-phase) SW4
 000	20 A	30 A	 100	12A	22 A
 001	18 A	28 A	 101	12A	20 A
 010	16 A	26 A	 110	12A	18 A
 011	14 A	24 A	 111	12A	16 A

Initial start-up at low outdoor ambient temperatures

During initial start-up and when water temperature is low, it is important that the water is heated gradually. Failure to do so may result in concrete floors cracking due to rapid temperature change. Please contact the responsible cast concrete building contractor for further details.

To do so, the lowest water flow set temperature can be decreased to a value between 25°C and 35°C by adjusting the FOR SERVICEMAN - SPECIAL FUNCTION - PREHEATING FOR FLOOR

Pre-operation checks

Checks before initial start-up.

DANGER

Switch off the power supply before making any connections.

After the installation of the unit, check the following before switching on the circuit breaker:

- Field wiring :
Make sure that the field wiring between the local supply panel and unit and valves (when applicable), unit and room thermostat (when applicable), unit and domestic hot water tank, and unit and backup heater kit have been connected according to the instructions described in the chapter Electrical connections, according to the wiring diagrams and to local laws and regulations.
- Fuses, circuit breakers, or protection devices:
Check that the fuses or the locally installed protection devices are of the size and type specified in the page 56,57 on the chapter Electrical connections.
Make sure that no fuses or protection devices have been bypassed.
- Backup heater circuit breaker :
Do not forget to turn on the backup heater circuit breaker in the switchbox (it depends on the backup heater type).
Refer to the wiring diagram.
- Booster heater circuit breaker : Do not forget to turn on the booster heater circuit breaker (applies only to units with optional domestic hot water tank installed).

- Ground wiring :
Make sure that the ground wires have been connected properly and that the ground terminals are tightened.
- Internal wiring :
Visually check the switch box for loose connections or damaged electrical components.
- Mounting :
Check that the unit is properly mounted, to avoid abnormal noises and vibrations when starting up the unit.
- Damaged equipment :
Check the inside of the unit for damaged components or squeezed pipes.
- Refrigerant leak :
Check the inside of the unit for refrigerant leakage. If there is a refrigerant leak, call your local dealer.
- Power supply voltage :
Check the power supply voltage on the local supply panel.
The voltage must correspond to the voltage on the identification label of the unit.
- Air purge valve :
Make sure the air purge valve is open (at least 2 turns).
- Shut-off valves :
Make sure that the shut-off valves are fully open.

Powering up the unit

When power to the unit is turned on, "1%~99%" is displayed on the user interface during initialization.
During this process the user interface cannot be operated.

Setting the pump speed

The pump speed can be selected by adjusting the red knob on the pump.

The notch point indicates pump speed.

The default setting is the highest speed (III).

If the water flow in the system is too high the speed can be set to low (I).

The available external static pressure function for water flow is shown in the graph below.

DANGER

Operating the system with closed valves will damage the circulation pump!

5/7/9kW - Available external static pressure VS flowrate

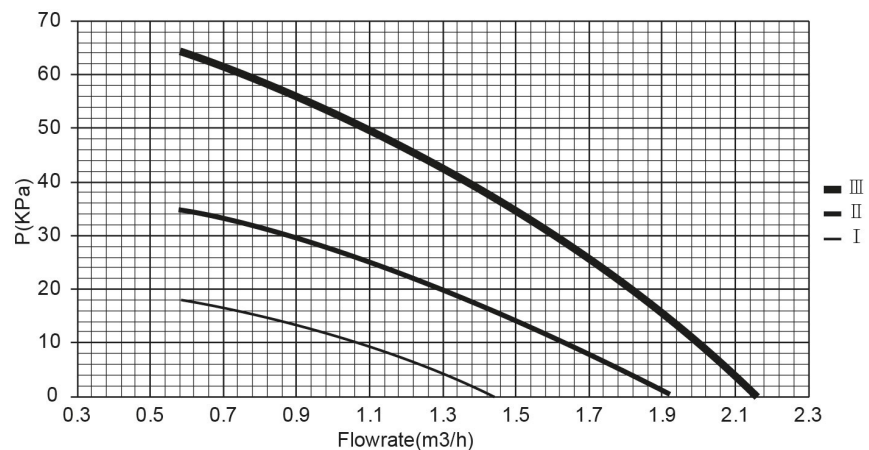
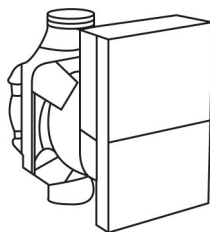

12/14/16kW - Available external static pressure VS flowrate

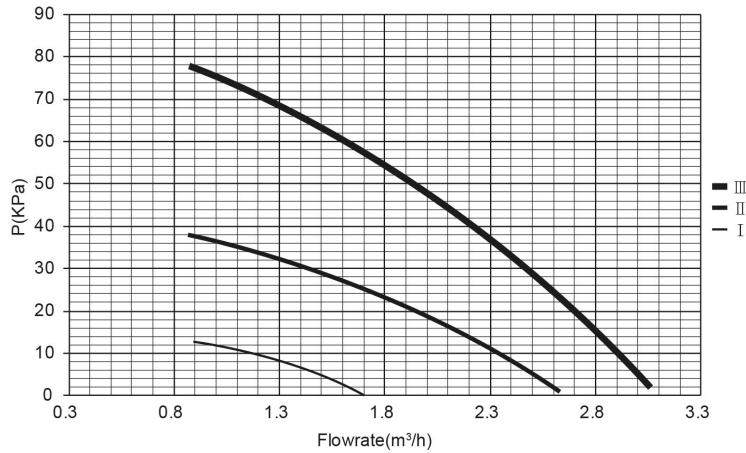

DANGER

If it's necessary to check the running status of the pump when unit power on.
Please do not touch the internal electronic control box components to avoid electric shock.

1) Pump LED diagnosis and solutions

The pump has an LED operating status display. This makes it easy for the technician to search for the cause of a fault in the heating system.

- If the LED display lights up continuously green, it means the pump is running normally.
- If the LED display is flashing green, it means the pump is running the venting function.
The pump runs during the 10 minute venting function.
After its cycle, the installer needs to adjust the targeted performance.
- If the LED is flashing green/red, it means that the pump has stopped operating due to an external reason.
The pump will restart by itself after the abnormal situation disappears.
The probable reason causing the problem is pump undervoltage or overvoltage ($U < 160V$ or $U > 280V$), and you should check the voltage supply.
Another reason is module overheating, and you should check the water and ambient temperatures.
- If the LED is flashing red, it means the pump has stopped operating, and a serious fault has happened (e.g. pump blocked).
The pump cannot restart itself due to a permanent failure and the pump should be changed.
- If the LED does not light up, it means no power supply to the pump, possibly the pump is not connected to power supply.
Check the cable connection.
If the pump is still running, it means the LED is damaged.
Or the electronics are damaged and the pump should be changed.

2) Failure diagnosis at the moment of first installation

- If nothing is displayed on the user interface, it is necessary to check for any of the following abnormalities before diagnosing possible error codes.
-Disconnection or wiring error (between power supply and unit and between unit and user interface).
-The fuse on the PCB may have blown.
- If the user interface shows "E8" or "E0" as an error code, there is a possibility that there is air in the system, or the water level in the system is less than the required minimum.
- If the error code E2 is displayed on the user interface, check the wiring between the user interface and unit.

More error code and failure causes can be found, see the chapter TROUBLESHOOTING - ERROR CODES.

The unit shall be configured by the installer to match the installation environment (outdoor climate, installed options, etc.) and user demand.

A number of field settings are available. These settings are accessible and programmable through “FOR SERVICEMAN” in user interface.

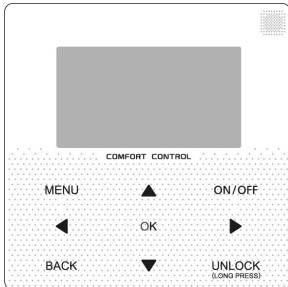

Keys	Function
MENU	Go to the menu structure(on the home page)
LEFT RIGHT UP DOWN	Navigate the cursor on the display Navigate in the menu structure Adjust settings
ON/OFF	Turn on/off the space heating/cooling operation or DHW mode Turn on/or off functions in the menu structure
BACK	Come back to the up level
UNLOCK	Long press for unlock /lock the controller Unlock /lock some functions such as “DHW temperature adjusting ”
OK	Go to the next step when programming a schedule in the menu structure; and confirm a selection to enter in the submenu of the menu structure.

FOR SERVICEMAN

FOR SERVICEMAN is designed for the installer to set the parameter.

- Setting the composition of equipment.
- Setting the parameter.

How to go to FOR SERVICEMAN

Go to MENU> FOR SERVICEMAN.

Press OK

Use LEFT RIGHT UP DOWN to navigate and to adjust the numerical value.

Press OK.

The password is 234.

Use UP DOWN to scroll and use “ok” to enter submenu for setting the parameters.

NOTE

The parameters relating to the functions reserved for technicians are shown at the end of the chapter.

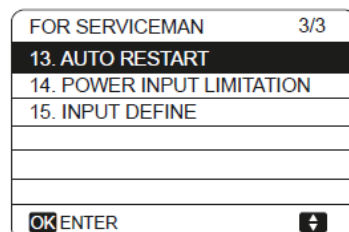
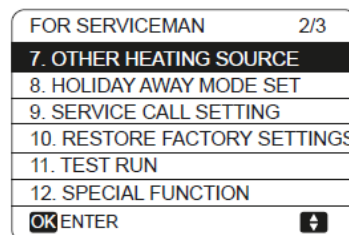
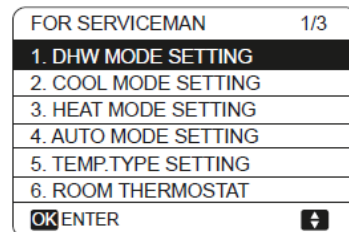
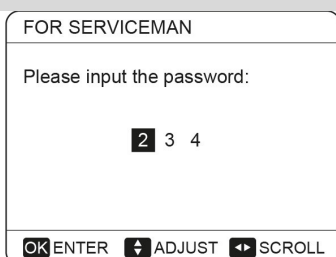

DHW mode

How to set the DHW mode

To determine whether the DHW mode is effective.
Go to MENU> FOR SERVICEMAN> DHW MODE SETTING. Press OK. The following page is displayed:

1 DHW MODE SETTING	1/5
1.1 DHW MODE	YES
1.2 DISINFECT	YES
1.3 DHW PRIORITY	YES
1.4 DHW PUMP	YES
1.5 DHW PRIORITY TIME SET	NON
ADJUST	

1 DHW MODE SETTING	2/5
1.6 dT5_ON	5 °C
1.7 dT1S5	10 °C
1.8 T4DHWMAX	43 °C
1.9 T4DHWMIN	-10 °C
1.10 t_INTERVAL_DHW	5 MIN
ADJUST	

1 DHW MODE SETTING	3/5
1.11 dT5_TBH_OFF	5 °C
1.12 T4_TBH_ON	5 °C
1.13 t_TBH_DELAY	30 MIN
1.14 T5S_DI	65 °C
1.15 t_DI HIGHTEMP.	15MIN
ADJUST	

1 DHW MODE SETTING	4/5
1.16 t_DI_MAX	210 MIN
1.17 t_DHWHP_RESTRICT	30 MIN
1.18 t_DHWHP_MAX	120 MIN
1.19 DHWPUMP TIME RUN	YES
1.20 PUMP RUNNING TIME	5 MIN
ADJUST	

1 DHW MODE SETTING	5/5
1.21 DHW PUMP DI RUN	NON
ADJUST	

Cooling mode setting

How to set the Cooling mode

To determine whether the COOLING mode is effective, go to MENU> FOR SERVICEMAN> COOL MODE SETTING. Press OK.

The following page will be displayed:

2 COOL MODE SETTING	1/3
2.1 COOL MODE	YES
2.2 t_T4_FRESH_C	2.0HRS
2.3 T4CMAX	43 °C
2.4 T4CMIN	20 °C
2.5 dT1SC	5 °C
ADJUST	

2 COOL MODE SETTING	2/3
2.6 dTSC	2 °C
2.7 t_INTERVAL_C	5MIN
2.8 T1SetC1	10 °C
2.9 T1SetC2	16 °C
2.10 T4C1	35 °C
ADJUST	

2 COOL MODE SETTING	3/3
2.11 T4C2	25 °C
2.12 ZONE1 C-EMISSION	FCU
2.13 ZONE2 C-EMISSION	FLH
ADJUST	

Heating mode

How to set the Heat mode

To determine whether the HEAT mode is effective, go to MENU > FOR SERVICEMAN > HEAT MODE SETTING. Press OK.

The following page be displayed:

3 HEAT MODE SETTING	1/3
3.1 HEAT MODE	YES
3.2 t_T4_FRESH_H	2.0HRS
3.3 T4HMAX	16 °C
3.4 T4HMIN	-15 °C
3.5 dT1SH	5 °C
ADJUST	

3 HEAT MODE SETTING	2/3
3.6 dTSH	2 °C
3.7 t_INTERVAL_H	5MIN
3.8 T1SetH1	35 °C
3.9 T1SetH2	28 °C
3.10 T4H1	-5 °C
ADJUST	

3 HEAT MODE SETTING	3/3
3.11 T4H2	7 °C
3.12 ZONE1 H-EMISSION	RAD.
3.13 ZONE2 H-EMISSION	FLH
3.14 t_DELAY_PUMP	2MIN
ADJUST	

Auto mode

How to set the AUTO mode

To determine whether the AUTO mode is effective, go to MENU > FOR SERVICEMAN > AUTO MODE SETTING.

Press OK.

The following page is displayed.

4 AUTO. MODE SETTING	
4.1 T4AUTOCMIN	25°C
4.2 T4AUTOHMAX	17°C
← ADJUST	▶

Temperature type setting

The TEMP. TYPE SETTING is used for selecting whether the water flow temperature or room temperature (detected by the temperature sensor attached in the user interface) is used to control the ON/OFF of the heat pump.

When ROOM TEMP. is enabled, the target outlet water temperature will be calculated from climate-related curves (see chapter Start-up and configuration -Climate related curves”).

How to enter the temperature

To enter the TEMP. TYPE SETTING, go to MENU > FOR SERVICEMAN > TEMP. TYPE SETTING.

Press OK.

The following page is displayed:

5 TEMP. TYPE SETTING	
5.1 WATER FLOW TEMP.	YES
5.2 ROOM TEMP.	NON
5.3 DOUBLE ZONE	NON
← ADJUST	▶

Only WATER FLOW TEMP = YES

01-01-2018	23:59	13°
♁	ON	♁
Δ 23 °C	☀	38 °C

Only ROOM TEMP = YES

01-01-2018	23:59	13°
♁	ON	♁
23.5 °C	☀	38

WATER FLOW TEMP = YES + ROOM TEMP = YES

Zone 1 Zone 2

01-01-2018	23:59	13°	01-01-2018	23:59	13°
♁	ON	♁	♁ ₂	ON	☀
Δ 23 °C	☀	38 °C	23.5 °C	☀	

In this case the setpoint for zone 1 is T1S, the setpoint for zone 2 is TS (TIS2 is calculated in accordance with the climatic curve).

DOUBLE ZONE = YES + ROOM TEMP = NO

Zona 1 Zona 2

01-01-2018	23:59	13°	01-01-2018	23:59	13°
♁	ON	♁	♁ ₂	ON	☀
Δ 23 °C	☀	38 °C	Δ 23 °C	☀	

DOUBLE ZONE = YES + ROOM TEMP = YES

Zone 1 Zone 2

01-01-2018	23:59	13°	01-01-2018	23:59	13°
♁	ON	♁	♁ ₂	ON	☀
Δ 23 °C	☀	38 °C	23.5 °C	☀	

Restore factory settings

The RESTORE FACTORY SETTING is used to restore all the parameters set in the user interface to the factory setting.

To restore factory settings, go to MENU > FOR SERVICEMAN > RESTORE FACTORY SETTINGS.

Press OK.

The following page is displayed:

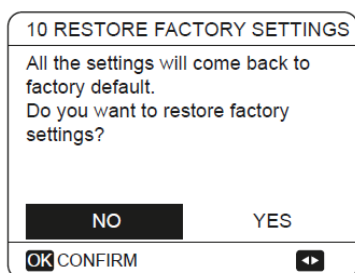

Use LEFT RIGHT to scroll the cursor to YES and press OK.

The following page will be displayed:

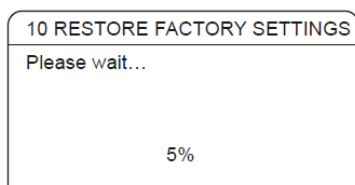

After a few seconds, all the parameters set in the user interface will be restored to factory settings.

Test run

TEST RUN is used to check correct operation of the valves, air purge, circulation pump operation, cooling, heating and domestic water heating.

How to enter test run

To enter test run, go to MENU > FOR SERVICEMAN > TEST RUN.

Press OK.

The following page is displayed:

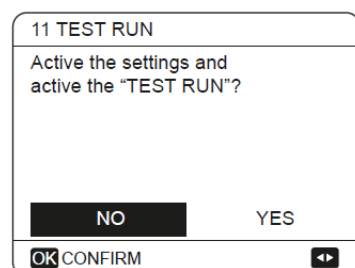

If YES is selected, the following page is displayed:

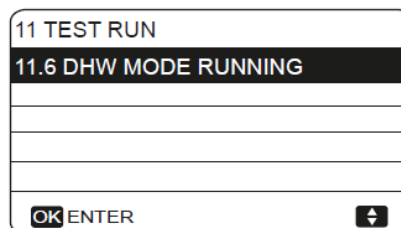
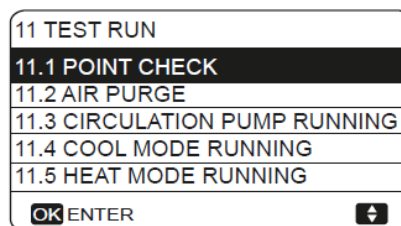

Use UP DOWN to scroll to the mode you want to run and press OK.

The unit will run as selected.

If POINT CHECK is selected, the following page will appear:

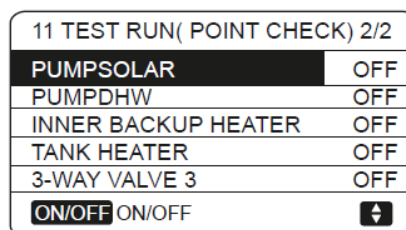
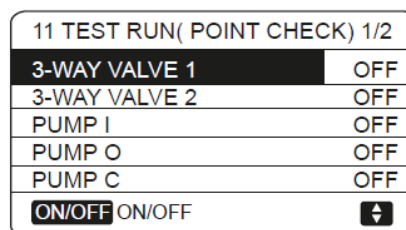

Use UP DOWN to scroll to the components you want to check and press ON/OFF. For example, when 3-WAY VALVE is selected and ON/OFF is pressed, if the 3-way valve is open/close, then the operation of 3-way valve is normal, and so are other components.

NOTE

Before the test run, make sure that the system is filled and vented.

Otherwise the pump and the backup resistor can be damaged.

7 START-UP AND CONFIGURATION

If you select AIR PURGE :

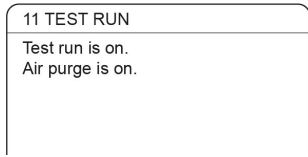

When in air purge mode, the 3-way valve will open, the 2-way valve will close.

60s later the pump in the unit (PUMPI) will operate for 10min during which the flow switch will not work.

After the pump stops, the 3-way valve will close and the 2-way valve will open.

60s later both the PUMPI and PUMPO will operate until the next command is received.

When CIRCULATION PUMP RUNNING is selected, the page will displayed as follows:

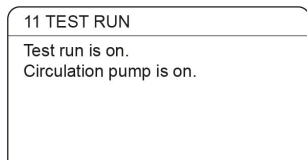

When CIRCULATION PUMP RUNNING is turned on, all running components will stop.

60 minutes later, the 3-way valve will open, the 2-way valve will close, 60 seconds later PUMPI will operate.

30s later, if the flow switch checked normal flow, PUMPI will operate for 3min, after the pump stops, the 3-way valve will close and the 2-way valve will open.

60s later the both PUMPI and PUMPO will operate, 2 mins later, the flow switch will check the water flow.

If the flow switch closes for 15s, PUMPI and PUMPO will operate until the next command is received.

When the COOL MODE RUNNING is selected, the page will displayed as follows:

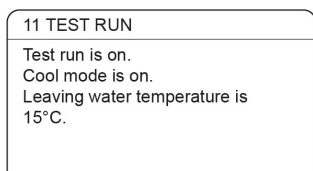

During COOL MODE test running, the default target outlet water temperature is 7°C.

The unit will operate until the water temperature drops to a certain value or the next command is received.

When the HEAT MODE RUNNING is selected, the page will displayed as follows:

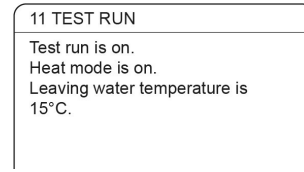

During HEAT MODE test running, the default target outlet water temperature is 35°C.

The first backup heater will turn on after the compressor runs for 10 min, 60s later the second backup heater will turn on.

After the two backup heater runs for 3 min, both backup heaters will turn off, the heat pump will operate until the water temperature increase to a certain value or the next command is received.

When the DHW MODE RUNNING is selected, the page will displayed as follows:

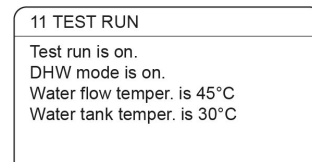

During DHW MODE test running, the default target temperature of the domestic water is 55°C.

The booster heater will turn on after the compressor runs for 10min.

The booster heater will turn off 3 min later, the heat pump will operate until the water temperature increase to a certain value or the next command is received.

During test run, all buttons except OK are invalid.

If you want to turn off the test run, please press OK.

For example ,when the unit is in air purge mode, after you press OK, the page will displayed as follows:

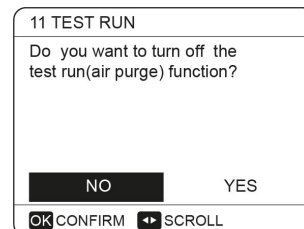

Use LEFT RIGHT to scroll the cursor to YES and press OK. The test run will turn off.

Special functions

When special functions are active, the wired controller cannot operate, it is not possible to return to the homepage and the screen shows the page where the specific function is running.

NOTE

The special functions can be used by service man only, during special function operating other functions (SCHEDULE , HOLIDAY AWAY, HOLIDAY HOME) can't be used.

Go to MENU> FOR SERVICEMAN> SPECIAL FUNCTION. Before activating the underfloor heating, it is necessary to gradually heat it to remove the water contained, otherwise there is a risk of breakage.

12 SPECIAL FUNCTION	
Active the settings and active the "SPECIAL FUNCTION"?	
NO	YES
OK CONFIRM	▶

12 SPECIAL FUNCTION	
12.1 PREHEATING FOR FLOOR	
12.2 FLOOR DRYING UP	
OK ENTER	▶

Use LEFT RIGHT to scroll and use OK to confirm. If PREHEATING FOR FLOOR is selected, after press OK ,the page will displayed as follows:

12.1 PREHEATING FOR FLOOR	
T1S	30°C
t_fristFH	72 HOURS
ENTER	EXIT
ADJUST	▶

When the cursor is on OPERATE PREHEATING FOR FLOOR, use LEFT RIGHT to scroll to YES and press OK. The page will be displayed as follows:

12.2 PREHEATING FOR FLOOR
Preheat for floor is running for 25 minutes. Water flow temperature is 20°C.

During preheating for floor, all the buttons except OK are invalid.

If you want to turn off the preheating for floor, please press OK. The following page will be displayed:

12.2 PREHEATING FOR FLOOR	
Do you want to turn off the preheating for floor function?	
NO	YES
OK CONFIRM	▶ SCROLL

The operation of the unit during preheating for floor described in the picture below:

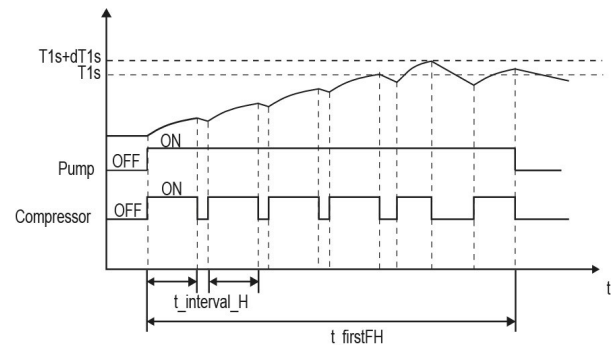

If FLOOR DRYING UP is selected, after press OK ,the page will displayed as follows:

12.2 FLOOR DRYING UP	
t_DRYUP	8 days
t_HIGHPEAK	5 days
t_DRYDOWN	5 days
T_DRYPEAK	45°C
START TIME	15:00
ADJUST	▶

12.2 FLOOR DRYING UP	
START DAY	01-01-2019
ENTER	EXIT
ADJUST	▶

7 START-UP AND CONFIGURATION

When the cursor is on OPERATE FLOOR DRYING?
Use UP DOWN to scroll to YES and press OK.
The page will be displayed as follows:

12.2 FLOOR DRYING UP	
DO YOU WANT TO TURN OFF THE	
FLOOR DRYING UP FUNCTION?	
NO	YES
OK CONFIRM	

During floor drying, all the buttons except OK are invalid.
When the heat pump malfunctions, the floor drying mode will
turn off when the backup heater and additional heating
source is unavailable.
If you want to turn off floor drying up, please press OK.
The following page will be displayed:

12.3 FLOOR DRYING UP	
THE UNIT WILL OPERATE FLOOR	
DRYING UP ON 09:00 01-03-2018.	
OK CONFIRM	

The target outlet water temperature during floor drying up
described in the picture below:

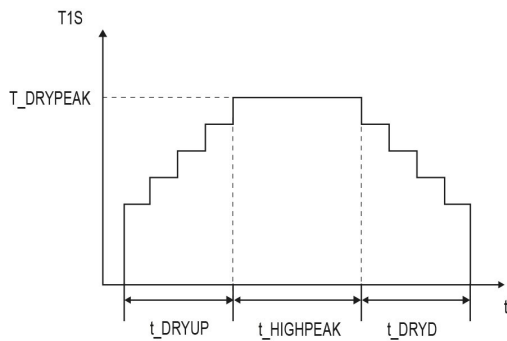

Auto restart

The AUTO RESTART function is used to select whether the
unit reapplies the user interface settings at the time when
power returns after a power supply failure.

How to set the auto restart

Go to MENU > FOR SERVICEMAN > AUTO RESTART

13 AUTO RESTART	
13.1 COOL/HEAT MODE	YES
13.2 DHW MODE	NON
ADJUST	

If the auto restart function is enabled, when power returns
after a power supply failure, the AUTO RESTART function
reapplies the user interface settings at the time of the power
supply failure.

Power input limitation

14 POWER INPUT LIMITATION	
14.1 POWER INPUT LIMITATION	0
ADJUST	

Input define

15 INPUT DEFINE	
15.1 ON/OFF (M1M2)	REMOTE
15.2 SMART GRID	NON
15.3 T1b (Tw2)	NON
15.4 Ta	HMI
15.5 Ta-adj	-2 °C
ADJUST	

Test run and final check

The installer is obliged to verify correct operation of unit after installation.

Final check

Before switching on the unit, read following recommendations:

- When the complete installation and all necessary settings have been carried out, close all front panels of the unit and refit the unit cover.
- The service panel of the switch box may only be opened by a licensed electrician for maintenance.

NOTE

That during the first running period of the unit, required power input may be higher than stated on the nameplate of the unit.

This phenomenon originates from the compressor that needs elapse of a 50 hours run in period before reaching smooth operation and stable power consumption.

Test run operation (manual)

If required, the installer can perform a manual test run operation at any time to check correct operation of air purge, heating, cooling and domestic water heating, refer to TEST RUN.

7 START-UP AND CONFIGURATION

Parameters relating to functions reserved for technicians.

	Code	State	Default	Min	max	setting interval	unit
1.1	DHW MODE	Enable or disable the DHW mode:0=NON,1=YES	1	0	1	1	/
1.2	DISINFECT	Enable or disable the disinfect mode:0=NON,1=YES	1	0	1	1	/
1.3	DHW PRIORITY	Enable or disable the DHW priority mode:0=NON,1=YES	1	0	1	1	/
1.4	DHW PUMP	Enable or disable the DHW pump mode:0=NON,1=YES	0	0	1	1	/
1.5	DHW PRIORITY TIME SET	Enable or disable the DHW priority time set:0=NON,1=YES	0	0	1	1	/
1.6	dT5_ON	The temperature difference for starting the heat pump	5	2	10	1	°C
1.7	dT1S5	The correct value to adjust the output of the compressor.	10	5	40	1	°C
1.8	T4DHWMAX	The maximum ambient temperature that the heat pump can operate at for domestic water heating	43	35	43	1	°C
1.9	T4DHWMIN	The minimum ambient temperature that the heat pump can operate for domestic water heating	-10	-25	5	1	°C
1.10	t_INTERVAL_DHW	the start time interval of the compressor in DHW mode.	5	5	30	1	MIN
1.11	dT5_TBH_OFF	the temperature difference between T5 and T5S that turns the booster heater off.	5	0	10	1	°C
1.12	T4_TBH_ON	the highest outdoor temperature the TBH can operate.	5	-5	20	1	°C
1.13	t_TBH_DELAY	the time that the compressor has run before starting the booster heater	30	0	240	5	MIN
1.14	T5S_DI	the target temperature of water in the domestic hot water tank in the DISINFECT function.	65	60	70	1	°C
1.15	t_DI_HIGHTEMP.	the time that the highest temperature of water in the domestic hot water tank in the DISINFECT function will last	15	5	60	5	MIN
1.16	t_DI_MAX	the maximum time that disinfection will last	210	90	300	5	MIN
1.17	t_DHWHP_RESTRICT	the operation time for the space heating/cooling operation.	30	10	600	5	MIN
1.18	t_DHWHP_MAX	the maximum continuous working period of the heat pump in DHW PRIORITY mode.	90	10	600	5	MIN
1.19	PUMP RUNNING TIME	the certain time that the DHW pump will keep running for	5	5	120	1	MIN
1.20	DHW PUMP TIME RUN	Enable or disable the DHW pump run as timed and keeps running for PUMP RUNNING TIME:0=NON,1=YES	1	0	1	1	/
1.21	DHW PUMP DISINFECT	Enable or disable the DHW pump operate when the unit is in disinfect mode and $T5 \geq T5S_DI-2$:0=NON,1=YES	1	0	1	1	/
2.1	COOL MODE	Enable or disable the cooling mode:0=NON,1=YES	1	0	1	1	/
2.2	t_T4_FRESH_C	The refresh time of climate related curves for cooling mode	0.5	0.5	6	0.5	hours
2.3	T4CMAX	The highest ambient operation temperature for cooling mode	52	35	52	1	°C
2.4	T4CMIN	the lowest ambient operating temperature for cooling mode	10	-5	25	1	°C
2.5	dT1SC	the temperature difference for starting the heat pump(T1)	5	2	10	1	°C
2.6	dTSC	the temperature difference for starting the heat pump(Ta)	2	1	10	1	°C
2.7	t_INTERVAL_C	the start time interval of the compressor in cooling mode.	5	5	30	1	MIN
2.8	T1SETC1	The setting temperature 1 of climate related curves for cooling mode.	10	5	25	1	°C
2.9	T1SETC2	The setting temperature 2 of climate related curves for cooling mode.	16	5	25	1	°C

Default: factory value

Setting interval: adjustment range

	Code	State	Default	Min	max	setting interval	unit
2.10	T4C1	The ambient temperature 1 of climate related curves for cooling mode.	35	-5	46	1	°C
2.11	T4C2	The ambient temperature 1 of climate related curves for cooling mode.	25	-5	46	1	°C
2.12	ZONE1 C-EMISSION	The type of zone1 end for cooling mode : 0=FCU(fan coil unit) , 1=RAD.(radiator) , 2=FLH(floor heating)	0	0	2	1	/
2.13	ZONE2 C-EMISSION	The type of zone2 end for cooling mode : 0=FCU(fan coil unit) , 1=RAD.(radiator) , 2=FLH(floor heating)	0	0	2	1	/
3.1	HEAT MODE	Enable or disable the heating mode	1	0	1	1	/
3.2	t_T4_FRESH_H	The refresh time of climate related curves for heating mode	0.5	0.5	6	0.5	hours
3.3	T4HMAX	The maximum ambient operating temperature for heating mode	25	20	35	1	°C
3.4	T4HMIN	The minimum ambient operating temperature for heating mode	-15	-25	15	1	°C
3.5	dT1SH	The temperature difference for starting the unit (T1)	5	2	10	1	°C
3.6	dTSH	The temperature difference for starting the unit (Ta)	2	1	10	1	°C
3.7	t_INTERVAL_H	The compressor start time interval	5	5	60	1	MIN
3.8	T1SETH1	The setting temperature 1 of climate related curves for heating mode	35	25	60	1	°C
3.9	T1SETH2	The setting temperature 2 of climate related curves for heating mode	28	25	60	1	°C
3.10	T4H1	The ambient temperature 1 of climate related curves for heating mode	-5	-25	35	1	°C
3.11	T4H2	The ambient temperature 2 of climate related curves for heating mode	7	-25	35	1	°C
3.12	ZONE1 H-EMISSION	The type of zone1 end for heating mode : 0=FCU(fan coil unit) , 1=RAD.(radiator) , 2=FLH(floor heating)	1	0	2	1	/
3.13	ZONE2 H-EMISSION	The type of zone2 end for heating mode : 0=FCU(fan coil unit) , 1=RAD.(radiator) , 2=FLH(floor heating)	2	0	2	1	/
3.14	t_DELAY_PUMP	the time that the compressor has run before starting the pump.	2	2	20	0.5	MIN
4.1	T4AUTOCMIN	The minimum operating ambient temperature for cooling in auto mode	25	20	29	1	°C
4.2	T4AUTOHMAX	The maximum operating ambient temperature for heating in auto mode	17	10	17	1	°C
5.1	WATER FLOW TEMP.	Enable or disable the WATER FLOW TEMP.:0=NON,1=YES	1	0	1	1	/
5.2	ROOM TEMP.	Enable or disable the ROOM TEMP.:0=NON,1=YES	0	0	1	1	/
5.3	DOUBLE ZONE	Enable or disable the ROOM THERMOSTAT DOUBLE ZONE:0=NON,1=YES	0	0	1	1	/
6.1	ROOM THERMOSTAT	The style of room thermostat : 0=NON,1=MODE SET,2=ONE ZONE,3=DOUBLE ZONE	0	0	3	1	/

7 START-UP AND CONFIGURATION

	Code	State	Default	Min	max	setting interval	unit
7.1	dT1_IBH_ON	The temperature difference between T1S and T1 for starting the backup heater.	5	2	10	1	°C
7.2	t_IBH_DELAY	The time that the compressor has run before the first backup heater turns on	30	15	120	5	MIN
7.3	T4_IBH_ON	The ambient temperature for starting the backup heater	-5	-15	10	1	°C
7.4	dT1_AHS_ON	The temperature difference between T1S and T1 for turning the additional heating source on	5	2	10	1	°C
7.5	t_AHS_DELAY	The time that the compressor has run before starting the additional heating source	30	5	120	5	MIN
7.6	T4_AHS_ON	The ambient temperature for starting the additional heating source	10	-15	10	1	°C
8.1	T1S_H.A_H	The target outlet water temperature for space heating when in holiday away mode	25	20	25	1	°C
8.2	T5S_H.A_DHW	The target outlet water temperature for domestic hot water heating when in holiday away mode	25	20	25	1	°C
12.1	PREHEATING FOR FLOOR T1S	The setting temperature of outlet water during first preheating for floor	25	25	35	1	°C
12.3	t_FIRSTFH	The time last for preheating floor	72	48	96	12	HOUR
12.4	t_DRYUP	The day for warming up during floor drying up	8	4	15	1	DAY
12.5	t_HIGHPEAK	The continue days in high temperature during floor drying up	5	3	7	1	DAY
12.6	t_DRYD	The day of dropping temperature during floor drying up	5	4	15	1	DAY
12.7	T_DRYPEAK	The target peak temperature of water flow during floor drying up	45	30	55	1	°C
12.8	START TIME	The start time of floor drying up	*	0:00	23:30	1/30	h/min
12.9	START DATE	The start date of floor drying up	The present date	1-1-2000	31-12-2099	1-1-2001	d/m/y
13.1	AUTO RESTART COOL/HEAT MODE	Enable or disable the auto restart cooling/heating mode. 0=NON · 1=YES	1	0	1	1	/
13.2	AUTO RESTART DHW MODE	Enable or disable the auto restart DHW mode. 0=NON · 1=YES	1	0	1	1	/
14.1	POWER INPUT LIMITATION	The type of power input limitation, 0=NON, 1~8=TYPE 1~8	0	0	8	1	/
15.1	CN12 ON/OFF	Define the CN12 port, 0= REMOTE ON/OFF, 1= TBH ON/OFF	0	0	1	1	/
15.2	CN15 T1B	Enable or disable the T1B PROBE. 0=NON ; 1=YES	0	0	1	1	/
15.3	CN35 SMART GRID	Enable or disable the SMART GRID. 0=NON ; 1=YES	0	0	1	1	/
15.4	Ta PROBE	Choose the sensor of Ta. 0=HMI Ta on wired controller; 1=IDU Ta connected on the mainboard of indoor unit	0	0	1	1	/
15.5	Ta-adj	Correct value of the Ta sensor in the user interface	-	-	-	-	-

* Hour : the present time (not on the hour +1, on the hour +2) Minute:00

8 SERVICE INFORMATION

DANGER

Risk of fire / flammable materials



- 1) Checks to the area
Prior to beginning work on systems containing flammable refrigerants, safety checks are necessary to ensure that the risk of ignition is minimised. For repair to the refrigerating system, the following precautions shall be complied with prior to conducting work on the system.
- 2) Work procedure
Works shall be undertaken under a controlled procedure so as to minimise the risk of a flammable gas or vapour being present while the work is being performed.
- 3) General work area
All maintenance staff and others working in the local area shall be instructed on the nature of work being carried out. Work in confined spaces shall be avoided. The area around the work space shall be sectioned off. Ensure that the conditions within the area have been made safe by control of flammable material.
- 4) Checking for presence of refrigerant
The area shall be checked with an appropriate refrigerant detector prior to and during work, to ensure the technician is aware of potentially flammable atmospheres. Ensure that the leak detection equipment being used is suitable for use with flammable refrigerants, i.e. no sparking, adequately sealed or intrinsically safe.
- 5) Presence of fire extinguisher
If any hot work is to be conducted on the refrigeration equipment or any associated parts, appropriate fire extinguishing equipment shall be available to hand. Have a dry power or CO2 fire extinguisher adjacent to the charging area.
- 6) No ignition sources
No person carrying out work in relation to a refrigeration system which involves exposing any pipe work that contains or has contained flammable refrigerant shall use any sources of ignition in such a manner that it may lead to the risk of fire or explosion. All possible ignition sources, including cigarette smoking, should be kept sufficiently far away from the site of installation, repairing, removing and disposal, during which flammable refrigerant can possibly be released to the surrounding space. Prior to work taking place, the area around the equipment is to be surveyed to make sure that there are no flammable hazards or ignition risks. NO SMOKING signs shall be displayed.
- 7) Ventilated area
Ensure that the area is in the open or that it is adequately ventilated before breaking into the system or conducting any hot work. A degree of ventilation shall continue during the period that the work is carried out. The ventilation should safely disperse any released refrigerant and preferably expel it externally into the atmosphere.
- 8) Checks to the refrigeration equipment
Where electrical components are being changed, they shall be fit for the purpose and to the correct specification. At all times the manufacturer's maintenance and service guidelines shall be followed. If in doubt consult the manufacturer's technical department for assistance. The following checks shall be applied to installations using flammable refrigerants:
 - The charge size is in accordance with the room size within which the refrigerant containing parts are installed;
 - The ventilation machinery and outlets are operating adequately and are not obstructed;
 - If an indirect refrigerating circuit is being used, the secondary circuits shall be checked for the presence of refrigerant; marking to the equipment continues to be visible and legible.
 - Marking and signs that are illegible shall be corrected;
 - Refrigeration pipe or components are installed in a position where they are unlikely to be exposed to any substance which may corrode refrigerant containing components, unless the components are constructed of materials which are inherently resistant to being corroded or are suitably protected against being so corroded.
- 9) Checks to electrical devices
Repair and maintenance to electrical components shall include initial safety checks and component inspection procedures. If a fault exists that could compromise safety, then no electrical supply shall be connected to the circuit until it is satisfactorily dealt with. If the fault cannot be corrected immediately but it is necessary to continue operation, and adequate temporary solution shall be used. This shall be reported to the owner of the equipment so all parties are advised.

Initial safety checks shall include:

- That capacitors are discharged: this shall be done in a safe manner to avoid possibility of sparking;
- That there no live electrical components and wiring are exposed while charging, recovering or purging the system;
- That there is continuity of earth bonding.

10) Repairs to sealed components

a) During repairs to sealed components, all electrical supplies shall be disconnected from the equipment being worked upon prior to any removal of sealed covers, etc. If it is absolutely necessary to have an electrical supply to equipment during servicing, then a permanently operating form of leak detection shall be located at the most critical point to warn of a potentially hazardous situation.

b) Particular attention shall be paid to the following to ensure that by working on electrical components, the casing is not altered in such a way that the level of protection is affected. This shall include damage to cables, excessive number of connections, terminals not made to original specification, damage to seals, incorrect fitting of glands, etc.

- Ensure that apparatus is mounted securely.
- Ensure that seals or sealing materials have not degraded such that they no longer serve the purpose of preventing the ingress of flammable atmospheres. Replacement parts shall be in accordance with the manufacturer s specifications.

NOTE

The use of silicon sealant may inhibit the effectiveness of some types of leak detection equipment. Intrinsically safe components do not have to be isolated prior to working on them.

11) Repair to intrinsically safe components

Do not apply any permanent inductive or capacitance loads to the circuit without ensuring that this will not exceed the permissible voltage and current permitted for the equipment in use. Intrinsically safe components are the only types that can be worked on while live in the presence of a flammable atmosphere.

The test apparatus shall be at the correct rating. Replace components only with parts specified by the manufacturer. Other parts may result in the ignition of refrigerant in the atmosphere from a leak.

12) Cabling

Check that cabling will not be subject to wear, corrosion, excessive pressure, vibration, sharp edges or any other adverse environmental effects.

The check shall also take into account the effects of aging or continual vibration from sources such as compressors or fans.

13) Detection of flammable refrigerants Under no circumstances shall potential sources of ignition be used in the searching for or detection of refrigerant leaks. A halide

14) Leak detection methods

The following leak detection methods are deemed acceptable for systems containing flammable refrigerants.

Electronic leak detectors shall be used to detect flammable refrigerants, but the sensitivity may not be adequate, or may need re-calibration.(Detection equipment shall be calibrated in a refrigerant-free area.)

Ensure that the detector is not a potential source of ignition and is suitable for the refrigerant.

Leak detection equipment shall be set at a percentage of the LFL of the refrigerant and shall be calibrated to the refrigerant employed and the appropriate percentage of gas (25% maximum) is confirmed.

Leak detection fluids are suitable for use with most refrigerants but the use of detergents containing chlorine shall be avoided as the chlorine may react with the refrigerant and corrode the copper pipe-work.

If a leak is suspected ,all naked flames shall be removed or extinguished. If a leakage of refrigerant is found which requires brazing, all of the refrigerant shall be recovered from the system, or isolated(by means of shut off valves) in a part of the system remote from the leak .

Oxygen free nitrogen(OFN) shall then be purged through the system both before and during the brazing process.

14) Removal and evacuation

When breaking into the refrigerant circuit to make repairs or for any other purpose conventional procedures shall be used, However, it is important that best practice is followed since flammability is a consideration. The following procedure shall be

- Remove refrigerant;
- Purge the circuit with inert gas; Evacuate;
- Purge again with inert gas;
- Open the circuit by cutting or brazing.
- The refrigerant charge shall be recovered into the correct recovery cylinders. The system shall be flushed with OFN to render the unit safe. This process may need to be repeated several times.
- Compressed air or oxygen shall not be used for this task.
- Flushing shall be achieved by breaking the vacuum in the system with OFN and continuing to fill until the working pressure is achieved, then venting to atmosphere, and finally pulling down to a vacuum. This process shall be repeated until no refrigerant is within the system.
- When the final OFN charge is used, the system shall be vented down to atmospheric pressure to enable work to take place. This operation is absolutely vital if brazing operations on the pipe-work are to take place.
- Ensure that the outlet for the vacuum pump is not closed to any ignition sources and there is ventilation available.

16) Charging procedures

In addition to conventional charging procedures, the following requirements shall be followed:

- Ensure that contamination of different refrigerants does not occur when using charging equipment. Hoses or lines shall be as short as possible to minimize the amount of refrigerant contained in them.
- Cylinders shall be kept upright.
Ensure that the refrigeration system is earthed prior to charging the system with refrigerant.
Label the system when charging is complete(if not already).
Extreme care shall be taken not to overfill the refrigeration system.
- Prior to recharging the system it shall be pressure tested with OFN. The system shall be leak tested on completion of charging but prior to commissioning. A follow up leak test shall be carried out prior to leaving the site.

17) Decommissioning

Before carrying out this procedure, it is essential that the technician is completely familiar with the equipment and all its detail. It is recommended good practice that all refrigerants are recovered safely. Prior to the task being carried out, an oil and refrigerant sample shall be taken.

In case analysis is required prior to re-use of reclaimed refrigerant. It is essential that electrical power is available before the task is commenced.

- a) Become familiar with the equipment and its operation.
- b) Isolate system electrically
- c) Before attempting the procedure ensure that:
 - Mechanical handling equipment is available, if required, for handling refrigerant cylinders;
 - All personal protective equipment is available and being used correctly;
 - The recovery process is supervised at all times by a competent person;
 - Recovery equipment and cylinders conform to the appropriate standards.
- d) Pump down refrigerant system, if possible.
- e) If a vacuum is not possible, make a manifold so that refrigerant can be removed from various parts of the system.
- f) Make sure that cylinder is situated on the scales before recovery takes place.
- g) Start the recovery machine and operate in accordance with manufacturer's instructions.
- h) Do not overfill cylinders. (No more than 80% volume liquid charge).
- i) Do not exceed the maximum working pressure of the cylinder, even temporarily.
- j) When the cylinders have been filled correctly and the process completed, make sure that the cylinders and the equipment are removed from site promptly and all isolation valves on the equipment are closed off.
- k) Recovered refrigerant shall not be charged into another refrigeration system unless it has been cleaned and checked.

18) Labelling

Equipment shall be labelled stating that it has been de-commissioned and emptied of refrigerant. The label shall be dated and signed. Ensure that there are labels on the equipment stating the equipment contains flammable refrigerant.

19) Recovery

- When removing refrigerant from a system, either for service or decommissioning, it is recommended good practice that all refrigerants are removed safely.
- When transferring refrigerant into cylinders, ensure that only appropriate refrigerant recovery cylinders are employed. Ensure that the correct numbers of cylinders for holding the total system charge are available.
- All cylinders to be used are designated for the recovered refrigerant and labelled for that refrigerant (i.e special cylinders for the recovery of refrigerant). Cylinders shall be complete with pressure relief valve and associated shut-off valves in good working order.
- Empty recovery cylinders are evacuated and, if possible, cooled before recovery occurs.
- The recovery equipment shall be in good working order with a set of instructions concerning the equipment that is at hand and shall be suitable for the recovery of flammable refrigerants. In addition, a set of calibrated weighing scales shall be available and in good working order.
- Hoses shall be complete with leak-free disconnect couplings and in good condition. Before using the recovery machine, check that it is in satisfactory working order, has been properly maintained and that any associated electrical components are sealed to prevent ignition in the event of a refrigerant release. Consult manufacturer if in doubt.
- The recovered refrigerant shall be returned to the refrigerant supplier in the correct recovery cylinder, and the relevant Waste Transfer Note arranged. Do not mix refrigerants in recovery units and especially not in cylinders.
- If compressors or compressor oils are to be removed, ensure that they have been evacuated to an acceptable level to make certain that flammable refrigerant does not remain within the lubricant. The evacuation process shall be carried out prior to retraining the compressor to the suppliers. Only electric heating to the compressor body shall be employed to accelerate this process. When oil is drained from a system, it shall be carried out safely.

20) Transportation, marking and storage for units

- Transport of equipment containing flammable refrigerants Compliance with the transport regulations
- Marking of equipment using signs Compliance with local regulations
- Disposal of equipment using flammable refrigerants Compliance with national regulations
- Storage of equipment/appliances
- The storage of equipment should be in accordance with the manufacturer's instructions.
- Storage of packed (unsold) equipment
- Storage package protection should be constructed such that mechanical damage to the equipment inside the package will not cause a leak of the refrigerant charge.
- The maximum number of pieces of equipment permitted to be stored together will be determined by local regulations.

9 MAINTENANCE

In order to ensure optimal availability of the unit, a number of checks and inspections on the unit and the field wiring have to be carried out at regular intervals.

This maintenance has to be carried out by your local Clivet technician.

DANGER

ELECTRIC SHOCK

- Before carrying out any maintenance or repair activity, always switch off the circuit breaker on the supply panel, remove the fuses (or switch off the circuit breakers) or open protection devices of the unit.
- Make sure that before starting any maintenance or repair activity that the power supply to the outdoor unit is switched off.
- Do not touch live parts for 10 minutes after the power supply is turned off because of high voltage risk.
- The heater for the compressor may operate even in stop mode.
- Please note that some sections of the electric component box are hot.
- Make sure you do not touch a conductive section.
- Do not rinse the unit. This may cause electric shocks or fire.
- When service panels are removed, live parts can be easily touched by accident.
- Never leave the unit unattended during installation or servicing when service panel is removed.

- Backup heater vessel insulation cover
Check that the backup heater insulation cover is fastened tightly around the backup heater vessel.
- Domestic hot water tank pressure relief valve (field supply).
Applies only to installations with a domestic hot water tank.
Check for correct operation of the pressure relief valve on the domestic hot water tank.
- Domestic hot water tank booster heater.
Applies only to installations with a domestic hot water tank. It is advisable to remove lime buildup on the booster heater to extend its life span, especially in regions with hard water.
To do so, drain the domestic hot water tank, remove the booster heater from the domestic hot water tank and immerse in a bucket (or similar) with lime-removing product for 24 hours.
- Unit switch box
Carry out a thorough visual inspection of the switch box and look for obvious defects such as loose connections or defective wiring.
Check for correct operation of contactors with an ohm meter. All contacts of these contactors must be in open position.
- Use of glycol
Refer to chapter WATER CONNECTIONS - Use of glycol
Document the glycol concentration and the pH-value in the system at least once a year.
A PH-value below 8.0 indicates that a significant portion of the inhibitor has been depleted and that more inhibitor needs to be added.
When the PH-value is below 7.0 then oxidation of the glycol occurred, the system should be drained and flushed thoroughly before severe damage occurs.
Make sure that the disposal of the glycol solution is done in accordance with relevant local laws and regulations.

The described checks must be executed at least once a year by qualified personnel.

- Water pressure
Check if the water pressure is above 1 bar. If necessary add water.
- Water filter
Clean the water filter.
- Water pressure relief valve
Check for correct operation of the pressure relief valve by turning the black knob on the valve counter-clockwise:
If you do not hear a clacking sound, contact your local dealer.
In case the water keeps running out of the unit, close both the water inlet and outlet shut-off valves first and then contact your local dealer.
- Pressure relief valve hose
Check that the pressure relief valve hose is positioned appropriately to drain the water.

Replacement of safety valve - Only for 12/14/16kw unit

Safety valve warranty period is 24 months.

Under the specified conditions, if flexible sealing parts is used, the safety valve life expectancy is 24 to 36 months, if metal or PIFE sealing components is used, the average life expectancy is 36 to 48 months.

Visual inspection is needed after that period, maintenance people should check the appearance of the valve body and the operating environment.

If the valve body is not obvious corrosion, cracks, dirt, damage, then the valve can be used continually.

Otherwise, please contact your supplier for spare part.

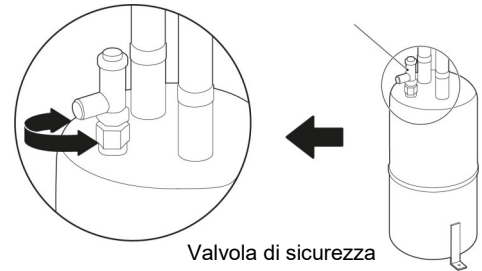

Replace the safety valve as follows (Suitable for type with safety valve):

- 1) Reclaim the refrigerant completely in the system. Doing so requires professional staff and equipment;
- 2) Note to protect the tank coating. Avoid damage to coating from external force or high temperature when removing and installing the safety valve;
- 3) Heat the sealant to screw off the safety valve. Note to protect the area where the screwing tool meets the tank body and avoid damages to the tank coating;
- 4) If tank coating is damaged, repaint the damaged area.

Disassembling the unit

5 / 7 / 9 kW

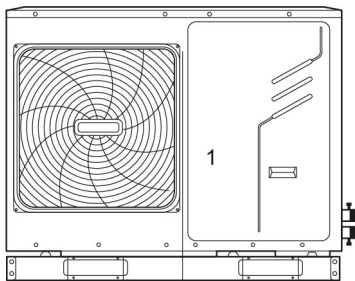

1. To access to the compressor and electrical parts and hydraulic compartment

12 / 14 / 16 kW

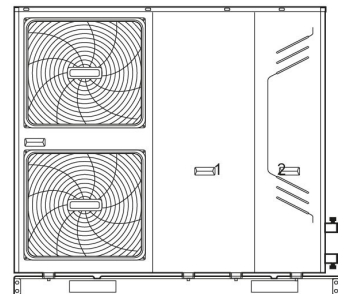

1. To access to the compressor and electrical parts.
2. To access to the hydraulic compartment and electrical parts.

WARNING

Switch off all power i.e. unit power supply and backup heater and domestic hot water tank power supply before removing doors 1 and 2.

Parts inside the unit may be hot.

Push the grill to the left until it stops, then pull its right edge, so you can removed the grill.

You can also reverse the procedure. Be careful to avoid hand injury.

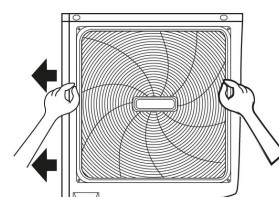
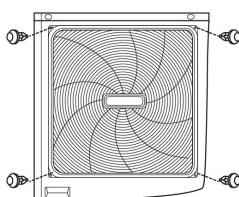

10 TROUBLE SHOOTING

This section provides useful information for diagnosing and correcting certain troubles which may occur in the unit. This troubleshooting and related corrective actions may only be carried out by your local technician.

General guidelines

Before starting the troubleshooting procedure, carry out a thorough visual inspection of the unit and look for obvious defects such as loose connections or defective wiring.

WARNIG

Quando si ispeziona il quadro elettrico dell'unità, accertarsi sempre che l'interruttore generale sia spento.

When a safety device was activated, stop the unit and find out why the safety device was activated before resetting it.

Under no circumstances can safety devices be bridged or changed to a value other than the factory setting.

If the cause of the problem cannot be found, call your local dealer.

If the pressure relief valve is not working correctly and is to be replaced, always reconnect the flexible hose attached to the pressure relief valve to avoid water dripping out of the unit!

NOTE

For problems related to the optional solar kit for domestic water heating, refer to the troubleshooting in the Installation & Owner's manual for that kit.

General symptoms

The unit is turned on but the unit is not heating or cooling as expected	
POSSIBLE CAUSES	CORRECTIVE ACTION
The temperature setting is not correct.	Check the controller set point. T4HMAX, T4HMIN in heat mode. T4CMAX, T4CMIN in cool mode. T4DHWMAX, T4DHWMIN in DHW mode.
The water flow is too low.	<ul style="list-style-type: none"> • Check that all shut off valves of the water circuit are completely open. • Check if the water filter needs cleaning. • Make sure there is no air in the system (purge air). • Check on the manometer that there is sufficient water pressure. The water pressure must be >1 bar (water is cold). • Make sure that the expansion vessel is not broken. • Check that the resistance in the water circuit is not too high for the pump.
The water volume in the installation is too low.	Make sure that the water volume in the installation is above the minimum required value (refer to WATER CONNECTIONS - Checking the water volume and expansion vessel pre-pressure").

The unit is turned on but the compressor is not starting (space heating or domestic water heating)	
POSSIBLE CAUSES	CORRECTIVE ACTION
<p>The unit must start up out of its operation range (the water temperature is too low).</p>	<p>In case of low water temperature, the system utilizes the backup heater to reach the minimum water temperature first (12°C).</p> <ul style="list-style-type: none"> • Check that the backup heater power supply is correct. • Check that the backup heater thermal fuse is closed. • Check that the backup heater thermal protector is not activated. • Check that the backup heater contactors are not broken.

Pump is making noise (cavitation)	
<p>There is air in the system.</p>	<p>Purge air.</p>
<p>Water pressure at pump inlet is too low.</p>	<ul style="list-style-type: none"> • Check on the manometer that there is sufficient water pressure. The water pressure must be > 1 bar (water is cold). • Check that the manometer is not broken. • Check that the expansion vessel is not broken. • Check that the setting of the pre- pressure of the expansion vessel is correct (refer to WATER CONNECTIONS - Checking the water volume and expansion vessel pre-pressure").

The water pressure relief valve opens	
<p>The expansion vessel is broken.</p>	<p>Replace the expansion vessel.</p>
<p>The filling water pressure in the installation is higher than 0.3MPa.</p>	<p>Make sure that the filling water pressure in the installation is about 0.15~0.20MPa (refer to WATER CONNECTIONS - Checking the water volume and expansion vessel pre-pressure").</p>

The water pressure relief valve leaks	
<p>Dirt is blocking the water pressure relief valve outlet.</p>	<p>Check for correct operation of the pressure relief valve by turning the red knob on the valve counter clockwise:</p> <ul style="list-style-type: none"> • If you do not hear a clacking sound, contact your local dealer. • In case the water keeps running out of the unit, close both the water inlet and outlet shut-off valves first and then contact your local dealer.

Space heating capacity shortage at low outdoor temperatures	
Backup heater operation is not activated.	<p>Check that the "OTHER HEATING SOURCE/ BACKUP HEATER" is enabled, see chapter 9 Start-up and configuration - OTHER HEATING SOURCE.</p> <p>Check whether or not the thermal protector of the backup heater has been activated (see chapter to Electronic board layout - main control board to thermal protector of the backup heater for location of the reset button).</p> <p>Check if booster heater is running, the backup heater and booster heater can't operate simultaneously.</p>
Too much heat pump capacity is used for heating domestic hot water (applies only to installations with a domestic hot water tank).	<p>Check that the 't_DHWHP_MAX' and "t_DHWHP_RESTRICT" are configured appropriately:</p> <ul style="list-style-type: none"> • Make sure that the 'DHW PRIORITY' in the user interface is disabled. • Enable the "T4_TBH_ON" in the user interface/FOR SERVICEMAN to activate the booster heater for domestic water heating.

Heat mode can't change to DHW mode immediately	
Volume of tank is too small and the location of water temperature probe not high enough	<ul style="list-style-type: none"> • Set dT1s5 to 20, and set t_DHWHP_RESTRICT to minimum value. • Set dT1SH to 2. • Enable TBH, and TBH should be controlled by the outdoor unit. • If AHS(boiler) is available, turn boiler on first, if requirement for turn heat pump on is fulfilled, the heat pump will turn on. • If both TBH and AHS are not available, try to change the position of T5 probe

DHW mode can't change to Heat mode immediately	
Heat exchanger for space heating not big enough	<ul style="list-style-type: none"> • Set t_DHWHP_MAX to minimum value, the suggested value is 60min. • If circulating pump out of unit is not controlled by unit, try to connect it to the unit. • Add 3-way valve at the inlet of fan coil to ensure enough water flow.
Space heating load is small	Normal , no need for heating
Disinfect function is enabled but without TBH	<ul style="list-style-type: none"> • Disable disinfect function • add TBH or AHS for DHW mode

DHW mode heat pump stop work but setpoint not reached, space heating require heat but unit stay in DHW mode	
Surface of coil in the tank not large enough	The same solution for Symptom 7
TBH or AHS not available	Heat pump will stay in DHW mode until t_DHWHP_MAX reached or setpoint is reached. Add TBH or AHS for DHW mode, TBH and AHS should be controlled by the unit.

Operation Parameter

This menu is for installer or service engineer reviewing the operation parameter.

- At home page, go to "MENU">"OPERATION PARAMETER".
- Press "OK".
- There are five pages for the operating parameter as following. Use UP DOWN scroll.

OPERATION PARAMETER 1/6	
OPERATE MODE	COOL
CURRENT	12A
COMPRESSOR FREQUENCY	24Hz
COMP.RUN TIME1	54MIN
COMP.RUN TIME2	65MIN
COMP.RUN TIME3	10MIN
↕	

OPERATION PARAMETER 2/6	
COMP. RUN TIME4	1000HOUR
EXPANSION VALVE	200P
FAN SPEED	600R/MIN
IDU TARGET FREQUENCY	46Hz
FREQUENCY LIMITED TYPE	5
T1 LEAVING WATER TEMP.	35°C
↕	

OPERATION PARAMETER 3/6	
T1B CIRCUIT2 WATER TEMP.	35°C
T2 PLATE F-OUT TEMP.	35°C
T2B PLATE F-IN TEMP.	35°C
T3 OUTDOOR EXCHANGE TEMP.	5°C
T4 OUTDOOR AIR TEMP.	5°C
T5 WATER TANK TEMP.	53°C
↕	

OPERATION PARAMETER 4/6	
Ta ROOM TEMP.	25°C
Th COMP. SUCTION TEMP.	5°C
Tp COMP. DISCHARGE TEMP.	75°C
TW_O PLATE W-OUTLET TEMP.	35°C
TW_I PLATE W-INLET TEMP.	30°C
P1 COMP.RESSURE	2300kPa
↕	

OPERATION PARAMETER 5/6	
T1S' C1 CLIMATE CURVE TEMP.	35°C
T1S2' C2 CLIMATE CURVE TEMP.	35°C
TF MODULE TEMP.	55°C
SUPPLY VOLTAGE	230V
POWER CONSUM.	1000kWh
DC GENERATRIX VOLTAGE	420V
↕	

OPERATION PARAMETER 6/6	
DC GENERATRIX CURRENT	18A
WATER FLOW	1.72M3/H
HEAT PUMP CAPACTIY	11.52kW
HMI SOFTWARE	XX-XX-XXXXXXXX
IDU SOFTWARE	XX-XX-XXXXXXXX
ODU SOFTWARE	XX-XX-XXXXXXXX
↕	

INFORMATION

The power consumption parameter is preparatory.
Some parameter is not be activated in the system, the parameter will show "--"

Error codes

When a safety device is activated, an error code will be displayed on the user interface.

A list of all errors and corrective actions can be found in the table below.

Reset the safety by turning the unit OFF and back ON.

In case this procedure for resetting the safety is not successful, contact your local dealer.

ERROR CODE	MALFUNCTION OR PROTECTION	FAILURE CAUSE AND CORRECTIVE ACTION
E0	Flow switch error (E8 displayed 3 times)	<ol style="list-style-type: none"> 1. The wire circuit is short connected or open. Reconnect the wire correctly. 2. Water flow rate is too low. 3. Water flow switch is failed, switch is open or close continuously, change the water flow switch.
E1	Phase sequence fault(only for threephase unit)	<ol style="list-style-type: none"> 1. Check the power supply cables should be connected stable, to avoid phase loss. 2. Check the power supply cables sequence, change any two cables sequence of the three power supply cables.
E2	Communication error between user interface and main control board of hydraulic module	<ol style="list-style-type: none"> 1. wire doesn't connect between wired controller and unit. connect the wire. 2. Communication wire sequence is not right. Reconnect the wire in the right sequence. 3. Whether there is a high magnetic field or high power interfere, such as lifts, large power transformers, etc.. <p>To add a barrier to protect the unit or to move the unit to the other place.</p>
1E3	2The backup heater exchanger outlet water temperature sensor (T1) error	<ol style="list-style-type: none"> 1. The T1 sensor connector is loosen. Reconnect it. 2. The T1 sensor connector is wet or there is water in. remove the water, make the connector dry. Add waterproof adhesive. 3. The T1 sensor failure, change a new sensor.
E4	The domestic hot water temperature sensor (T5) error.	<ol style="list-style-type: none"> 1. The T5 sensor connector is loosen. Reconnect it. 2. The T5 sensor connector is wet or there is water in. remove the water, make the connector dry. Add waterproof adhesive 3. The T5 sensor failure, change a new sensor.
E5	The condenser outlet refrigerant temperature sensor (T3)error.	<ol style="list-style-type: none"> 1. The T3 sensor connector is loosen. Reconnect it. 2. The T3 sensor connector is wet or there is water in. remove the water, make the connector dry. Add waterproof adhesive 3. The T3 sensor failure, change a new sensor.
E6	The ambient temperature sensor (T4) error.	<ol style="list-style-type: none"> 1. The T4 sensor connector is loosen. Reconnect it. 2. The T4 sensor connector is wet or there is water in. remove the water, make the connector dry. Add waterproof adhesive 3. The T4 sensor failure, change a new sensor.

ERROR CODE	MALFUNCTION OR PROTECTION	FAILURE CAUSE AND CORRECTIVE ACTION
E8	Water flow failure	<p>Check that all shut off valves of the water circuit are completely open.</p> <ol style="list-style-type: none"> 1. Check if the water filter needs cleaning. 2. Refer to chapter WATER CONNECTIONS - Charging water 3. Make sure there is no air in the system(purge air). 4. Check on the manometer that there is sufficient water pressure. The water pressure must be >1 bar. 5. Check that the pump speed setting is on the highest speed. 6. Make sure that the expansion vessel is not broken. 7. Check that the resistance in the water circuit is not too high for the pump (refer to "Setting the pump speed"). 8. If this error occurs at defrost operation (during space heating or domestic water heating), make sure that the backup heater power supply is wired correctly and that fuses are not blown. 9. Check that the pump fuse and PCB fuse are not blown.
E9	Suction temperature sensor(Th) error	<ol style="list-style-type: none"> 1. The Th sensor connector is loosen. Re connect it. 2. The Th sensor connector is wet or there is water in. remove the water, make the connector dry. Add waterproof adhesive 3. The Th sensor failure, change a new sensor.
EA	Discharge temperature sensor (Tp) error	<ol style="list-style-type: none"> 1. The Tp sensor connector is loosen. Re connect it. 2. The Tp sensor connector is wet or there is water in. remove the water, make the connector dry. Add waterproof adhesive 3. The Tp sensor failure, change a new sensor.
Ed	inlet water temperature sensor (Tw_in) error	<ol style="list-style-type: none"> 1. The Tw_in sensor connector is loosen. Re connect it. 2. The Tw_in sensor connector is wet or there is water in. remove the water, make the connector dry. Add waterproof adhesive 3. The Tw_in sensor failure, change a new sensor
EE	The main control board of hydraulic module EEPROM failure	<ol style="list-style-type: none"> 1. The EEPROM parameter is error, rewrite the EEPROM data. 2. EEPROM chip part is broken, change a new EEPROM chip part. 3. main control board of hydraulic module is broken, change a new PCB.
H0	Communication error between main control board PCB B and main control board of hydraulic module	<ol style="list-style-type: none"> 1. wire doesn't connect between main control board PCB B and main control board of hydraulic module. connect the wire. 2. Communication wire sequence is not right. Reconnect the wire in the right sequence. 3. Whether there is a high magnetic field or high power interfere, such as lifts, large power transformers, etc.. To add a barrier to protect the unit or to move the unit to the other place.

ERROR CODE	MALFUNCTION OR PROTECTION	FAILURE CAUSE AND CORRECTIVE ACTION
H1	Communication error between inverter module PCB A and main control board PCB B	<ol style="list-style-type: none"> Whether there is power connected to the PCB and driven board. Check the PCB indicator light is on or off. If Light is off, reconnect the power supply wire. if light is on, check the wire connection between the main PCB and driven PCB, if the wire loosen or broken, reconnect the wire or change a new wire. Replace a new main PCB and driven board in turn.
H2	The plate heat exchanger refrigerant inlet(liquid pipe) temperature sensor(T2) error.	<ol style="list-style-type: none"> The T2 sensor connector is loosen. Re connect it. The T2 sensor connector is wet or there is water in. remove the water, make the connector dry. Add waterproof adhesive The T2 sensor failure, change a new sensor.
H3	The plate heat exchanger refrigerant outlet(gas pipe) temperature sensor (T2B) error.	<ol style="list-style-type: none"> The T2B sensor connector is loosen. Re connect it. The T2B sensor connector is wet or there is water in. remove the water, make the connector dry. Add waterproof adhesive The T2B sensor failure, change a new sensor.
H4	Three times P6 protect	Same to P6
H5	The indoor temperature sensor (Ta) error	<ol style="list-style-type: none"> The Ta sensor is in the interface; The Ta sensor failure · change a new sensor or change a new interface.
H6	The DC fan failure	<ol style="list-style-type: none"> Strong wind or typhoon below toward to the fan, to make the fan running in the opposite direction. Change the unit direction or make shelter to avoid typhoon below to the fan. fan motor is broken, change a new fan motor.
H7	Main circuit voltage failure	<ol style="list-style-type: none"> Whether the power supply input is in the available range. Power off and power on for several times rapidly in short time. Remain the unit power off for more than minutes than power on. the circuit defect part of Main control board is defective. Replace a new Main PCB.
H8	Pressure sensor failure	<ol style="list-style-type: none"> Pressure sensor connector is loosen, reconnect it. Pressure sensor failure. change a new sensor.
H9	The system outlet water temperature sensor T1B failure.	<ol style="list-style-type: none"> The T1B sensor connector is loosen. Reconnect it. The T1B sensor connector is wet or there is water in. remove the water, make the connector dry. add waterproof adhesive The T1B sensor failure, change a new sensor.
HA	The plate heat exchanger water outlet temperature sensor (TW_out) error.	<ol style="list-style-type: none"> The TW_out sensor connector is loosen. Reconnect it. The TW_out sensor connector is wet or there is water in. remove the water, make the connector dry. add waterproof adhesive The TW_out sensor failure, change a new sensor.

10 TROUBLE SHOOTING

ERROR CODE	MALFUNCTION OR PROTECTION	FAILURE CAUSE AND CORRECTIVE ACTION
HE	The condenser refrigerant outlet temperature is too high in heating mode for more than 10 minutes.	The outside ambient temperature is too high(higher than 30°C, the unit still operate heat mode. close the heat mode when the ambient temperature is higher than 30° C.
HF	The main control board PCB B EEPROM failure	<ol style="list-style-type: none"> 1. The EEPROM parameter is error, rewrite the EEPROM data. 2. EEPROM chip part is broken, change a new EEPROM chip part. 3. Main PCB is broken, change a new PCB.
HH	H6 displayed 10 times in 2 hours	Refer to H6
HL	PFC module fault	Contact your local dealer
HP	Low pressure protection (Pe<0.6) occurred 3 times in an	Refer to P0
P0	Low pressure protection	<ol style="list-style-type: none"> 1. System is lack of refrigerant volume. Charge the refrigerant in right volume. 2. When at heating mode or heat water mode, Heat exchanger is dirty or something is block on the surface. Clean the heat exchanger or remove the obstruction. 3. The water flow is low in cooling mode. 4. Electrical expansion valve locked or winding connector is loosen. Tap-tap the valve body and plug in/ plug off the connector for several times to make sure the valve is working correctly. And install the winding in the right location.
P1	High pressure protection	<p>Heating mode, DHW mode:</p> <ol style="list-style-type: none"> 1. The water flow is low; water temp is high, whether there is air in the water system. Release the air. 2. Water pressure is lower than 0.1Mpa, charge the water to let the pressure in the range of 0.15~0.2Mpa. 3. Over charge the refrigerant volume. Recharge the refrigerant in right volume. 4. Electrical expansion valve locked or winding connector is loosen. Tap-tap the valve body and plug in/ plug off the connector for several times to make sure the valve is working correctly. And install the winding in the right location <p>DHW mode: Water tank heat exchanger is smaller than the required 1.7m².(10-16kW unit)or 1.4m² (5-9kW unit)</p> <p>Cooling mode:</p> <ol style="list-style-type: none"> 1.Heat exchanger cover is not removed. Remove it. 2.Heat exchanger is dirty or something is block on the surface. Clean the heat exchanger or remove the obstruction.
P3	Compressor overcurrent protection.	<ol style="list-style-type: none"> 1. The same reason to P1. 2. Power supply voltage of the unit is low, increase the power voltage to the required range.

ERROR CODE	MALFUNCTION OR PROTECTION	FAILURE CAUSE AND CORRECTIVE ACTION
P4	High discharge temperature protection.	<ol style="list-style-type: none"> 1. The same reason to P1. 2. System is lack of refrigerant volume. Charge the refrigerant in right volume. 3. TW_out temp sensor is loosen Reconnect it.. 4. T1 temp sensor is loosen. Reconnect it. 5. T5 temp sensor is loosen. Reconnect it.
P5	High Temperature difference protection between water inlet and water outlet of the plate heat exchanger.	<ol style="list-style-type: none"> 1. Check that all shut off valves of the water circuit are completely open. 2. Check if the water filter needs cleaning. 3. Refer to chapter WATER CONNECTIONS - Charging water" 4. Make sure there is no air in the system (purge air). 5. Check on the manometer that there is sufficient water pressure. The water pressure must be >1 bar(water is cold). 6. Check that the pump speed setting is on the highest speed. 7. Make sure that the expansion vessel is not broken. 8. Check that the resistance in the water circuit is not too high for the pump. (refer to START-UP AND CONFIGURATION - Setting the pump speed).
P6	Module protection	<ol style="list-style-type: none"> 1. Power supply voltage of the unit is low, increase the power voltage to the required range. 2. The space between the units is too narrow for heat exchange. Increase the space between the units. 3. Heat exchanger is dirty or something is block on the surface. Clean the heat exchanger or remove the obstruction. 4. Fan is not running. Fan motor or fan is broken, Change a new fan or fan motor. 5. Over charge the refrigerant volume. Recharge the refrigerant in right volume. 6. Water flow rate is low, there is air in system, or pump head is not enough. Release the air and reselect the pump. 7. Water outlet temp sensor is loosen or broken, reconnect it or change a new one. 8. water tank heat exchanger is smaller than the required 1.7m².(10-16kW unit) or 1.4m² (5-9kW unit). 9. Module wires or screws are loosen. Reconnect wires and screws. 10. The Thermal Conductive Adhesive is dry or drop.Add some thermal conductive adhesive. 11. The wire connection is loosen or drop. Reconnect the wire. 12. Drive board is defective, replace a new one. 13. If already confirm the control system has no problem, then compressor is defective, replace a new compressor.
P9	DC fan motor protect	Contact your local dealer

ERROR CODE	MALFUNCTION OR PROTECTION	FAILURE CAUSE AND CORRECTIVE ACTION
Pd	High temperature protection of refrigerant outlet temp of condenser.	<ol style="list-style-type: none"> 1. Heat exchanger cover is not removed. Remove it. 2. Heat exchanger is dirty or something is block on the surface. Clean the heat exchanger or remove the obstruction. 3. There is no enough space around the unit for heat exchanging. 4. fan motor is broken, replace a new one.
Pb	Anti-freeze mode protection	Unit will return to the normal operation automatically.
PP	Water inlet temperature is higher than water outlet in heating mode	<ol style="list-style-type: none"> 1. The water inlet/outlet sensor wire connector is loosen. Reconnect it. 2. The water inlet/outlet (TW_in /TW_out) sensor is broken, Change a new sensor. 3. Four-way valve is blocked. Restart the unit again to let the valve change the direction. 4. Four-way valve is broken, change a new valve.
F1	DC generatrix voltage is too low	<ol style="list-style-type: none"> 1. Check the power supply. 2. If the power supply is OK, and check if LED light is OK, check the voltage PN, if it is 380V, the problem usually comes from the main board. And if the light is OFF, disconnect the power, check the IGBT, check those dioxides, if the voltage is not correct, the inverter board is damaged, change it. 3. And if those IGBT are OK, which means the inverter board is OK, power form rectifier bridge is not correct, check the bridge. (Same method as IGBT, disconnect the power, check those dioxides are damaged or not). 4. Usually if F1 exist when compressor start, the possible reason is main board. If F1 exist when fan start, it may be because of inverter board.

11 MODBUS MAPPING TABLE

1 (PLC:40002)	Setting the mode	1: Auto; 2: Cool; 3: Heat; Others: Invalid			
2 (PLC:40003)	Setting water temperature T1s	Water temperature T1s is corresponding to the floor heating.			
3 (PLC:40004)	Setting air temperature Ts	The room temperature range is between 17°C and 30°C, and is valid when there is Ta.			
4 (PLC:40005)	T5s	The water tank temperature range is between 40°C and 60°C.			
5 (PLC:40006)	Function setting	BIT15	Reserved		
		BIT14	Reserved		
		BIT13	Reserved		
		BIT12	1: curve setting is enabled; 0: curve setting is disabled.		
		BIT11	DHW pump's running constant-temperature water recycling		
		BIT10	ECO mode		
		BIT9	Reserved		
		BIT8	Holiday home (the status can only be read, not changed)		
		BIT7	0: Silent mode level1; 1: Silent mode level2		
		BIT6	Silent mode		
		BIT5	Holiday away (the status can only be read, but cannot be changed)		
		BIT4	Disinfect		
		BIT3	Reserved		
		BIT2	Reserved		
		BIT1	Reserved		
		BIT0	Reserved		
		6 (PLC:40007)	Curve selection	Curve 1-8	
		7 (PLC:40008)	Forced water heating	0: Invalid 1: Forced on 2: Forced off	TBH is the electric water tank heater. IBH1 and 2 are the hydraulic module's rear electric heater. IBH1 and 2 can be activated together. TBH cannot be activated together with IBH1 and 2.
		8 (PLC:40009)	Forced TBH		
		9 (PLC:40010)	Forced IBH1		
10 (PLC:40011)	Forced IBH2				

In cooling mode, T1S low temp setting range is 5~25°C; T1S high temp setting range is 18~25°C.

In heating mode, T1S low temp setting range is 22~55°C; T1S high temp setting range is 35~60°

7.1.2 When the wired controller is connected to the hydraulic module, the parameters of the whole unit can be checked:

Whole unit parameter mapping address table

1) Running parameters

Register address	Description	Remarks
100 (PLC:40101)	Operating frequency	Compressor operating frequency in Hz
101 (PLC:40102)	Operating Mode	Whole unit's actual operating mode, 2: cooling, 3: heating, 0: off
102 (PLC:40103)	Fan Speed	Fan speed, in r/min
103 (PLC:40104)	PMV openness	Openness of the outdoor unit's electronic expansion valve in P
104 (PLC:40105)	Water inlet temperature	TW_in, in °C
105 (PLC:40106)	Water outlet temperature	TW_out, in °C
106 (PLC:40107)	T3 Temperature	Condenser temperature, in °C
107 (PLC:40108)	T4 Temperature	Outdoor ambient temperature in °C
108 (PLC:40109)	Discharge temperature	Compressor discharge temperature Tp in °C
109 (PLC:40110)	Return air temperature	Compressor air return temperature in °C
110 (PLC:40111)	T1	Total water outlet temperature in °C
111 (PLC:40112)	T1B	System total water outlet temperature (behind the auxiliary heater) °C
112 (PLC:40113)	T2	Refrigerant liquid side temperature in °C
113 (PLC:40114)	T2B	Refrigerant gas side temperature in °C
114 (PLC:40115)	Ta	Room temperature, in °C
115 (PLC:40116)	T5	Water tank temperature
116 (PLC:40117)	Pressure 1	Outdoor unit high pressure value, in kPA
117 (PLC:40118)	Pressure 2	Outdoor unit low pressure value, in kPA
118 (PLC:40119)	Outdoor unit current	Outdoor unit operating current, in A
119 (PLC:40120)	Outdoor unit voltage	Outdoor unit voltage in V
120 (PLC:40121)	Hydraulic module current 1	Hydraulic module current 1 in A
121 (PLC:40122)	Hydraulic module current 2	Hydraulic module current 2, in A
122 (PLC:40123)	Compressor operating time	Compressor operating time in hour
123 (PLC:40124)	Reserved	Reserved
124 (PLC:40125)	Current fault	Check the code table for detailed fault codes
125 (PLC:40126)	Fault 1	Check the code table for detailed fault codes.
126 (PLC:40127)	Fault 2	
127 (PLC:40128)	Fault 3	

128 (PLC:40129)	Status bit 1	BIT15	Reserved
		BIT14	Reserved
		BIT13	Reserved
		BIT12	Reserved
		BIT11	Reserved
		BIT10	Reserved
		BIT9	Reserved
		BIT8	Solar energy signal input
		BIT7	Room temperature controller cooling
		BIT6:	Room temperature controller heating
		BIT5:	Outdoor unit test mode mark
		BIT4:	Remote On/Off (1: d8)
		BIT3:	Oil return
		BIT2:	Anti-freezing
		BIT1:	Defrosting
		BIT0:	Enforced water pump
129 (PLC:40130)	Load output	BIT15	DEFROST
		BIT14	External heater
		BIT13	RUN
		BIT12	ALARM
		BIT11	Solar water pump
		BIT10	HEAT4
		BIT9	SV2
		BIT8	Mixed water pump P_c
		BIT7	Water return water P_d
		BIT6:	External water pump P_o
		BIT5:	Reserved
		BIT4:	SV1
		BIT3:	Water pump PUMP_I
		BIT2:	Electric heater TBH
		BIT1:	Electric heater IBH2
		BIT0:	Electric heater IBH1
130 (PLC:40131)	Whole unit version No.	1~99 is the whole unit's version number and refers to the hydraulic module's version number.	
131 (PLC:40132)	Wired controller version No.	1~99 is the wired controller's version number.	

Register address	Description	Remarks	
200 (PLC:40201)	Home appliance type	The upper 8 bit is the home appliance type: Central heating: 0x07	
201 (PLC: 40202)	Temperature upper limit of T1S cooling		
202 (PLC: 40203)	Temperature lower limit of T1S cooling		
203 (PLC: 40204)	Temperature upper limit of T1S heating		
204 (PLC: 40205)	Temperature lower limit of T1S heating		
205 (PLC: 40206)	Temperature upper limit of TS setting		
206 (PLC: 40207)	Temperature lower limit of TS setting		
207 (PLC: 40208)	Temperature upper limit of water hea-		
208 (PLC: 40209)	Temperature lower limit of water hea-		
209 (PLC: 40210)	PUMP RUNNING TIME	DHW PUMP water return running time. It is five minutes by default and can be adjusted between 5 and 120 min at an interval of 1 min.	
210 (PLC: 40211)	Parameter setting 1	BIT15	Enable water heating
		BIT14	Supports water tank electric heater TBH
		BIT13	Supports disinfection
		BIT12	DHW PUMP, 1: supported; 0: not supported
		BIT11	Reserved
		BIT10	DHW pump supports Pipe Disinfect
		BIT9	Enable cooling
		BIT8	T1S cooling high/low temperature settings
		BIT7	Enable heating
		BIT6:	T1S heating high/low temperature settings
		BIT5:	Supports T1 sensor
		BIT4:	Supports room temperature Sensor Ta
		BIT3:	Supports room thermostat
		BIT2:	Termostato ambiente
		BIT1:	Dual Room Thermostat, 0: not supported; 1: supported
		BIT0:	0: room cooling/heating first, 1: water heating first

11 MODBUS MAPPING TABLE







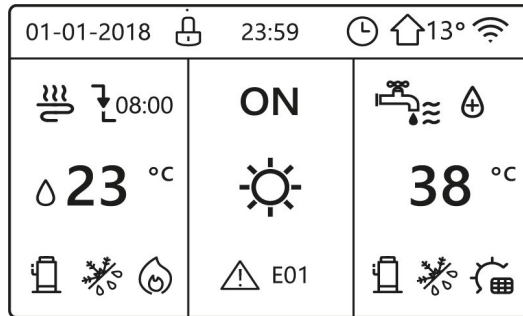





211 (PLC:40212)	Parameter setting 2	BIT15	Supports backup heater (IBH)
		BIT14	IBH supports heating
		BIT13	IBH supports water heating
		BIT12	Supports AHS
		BIT11	AHS supports heating
		BIT10	AHS supports water heating
		BIT9	Supports solar energy module
		BIT8	Reserved
		BIT7	Reserved
		BIT6:	Reserved
		BIT5:	Reserved
		BIT4:	Reserved
		BIT3:	Reserved
		BIT2:	Reserved
		BIT1:	Reserved
		BIT0:	Reserved
212 (PLC: 40213)	dT5_On	Default setting: 5°C, range: 2~10°C, setting interval: 1°C	
213 (PLC: 40214)	dT1S5	Default setting: 10°C, range: 5~20°C, setting interval: 1°C	
214 (PLC: 40215)	T_interval_DHW	Default setting: 5 min, range: 5~30 min, setting interval: 1 min	
215 (PLC: 40216)	T4DHWmax	Default setting: 43°C, range: 35~43°C, setting interval: 1°C	
216 (PLC: 40217)	T4DHWmin	Default setting: -10°C, range: -25~5°C, setting interval: 1°C	
217 (PLC: 40218)	t_TBH_delay	Default setting: 90 min, range: 0~240 min, setting interval: 5 min	
218 (PLC: 40219)	dT5_TBH_off	Default setting: 5°C, range: 0~10°C, setting interval: 1°C	
219 (PLC: 40220)	T4_TBH_on	Default setting: 5°C, range: -5~20°C, setting interval: 1°C	
220 (PLC: 40221)	T5s_DI	Temperature of the disinfection water tank, range: 60~70°C, default setting: 65°C	
221 (PLC: 40222)	t_DI_max	Maximum disinfection duration, range: 90~300 min, default setting: 210 min	
222 (PLC: 40223)	t_DI_hightemp	Disinfection high temperature duration, range: 5~60 min, default setting: 15 min	
223 (PLC: 40224)	t_interval_C	Time interval of compressor start-up in cooling mode; range: 5~30 min, default setting: 5 min	
224 (PLC: 40225)	dT1SC	Default setting: 5°C, range: 2~10°C, setting interval: 1°C	
225 (PLC: 40226)	dTSC	Default setting: 2°C, range: 1~10°C, setting interval: 1°C	
226 (PLC: 40227)	T4cmax	Default setting: 43°C, range: 35~46°C, setting interval: 1°C	
227 (PLC: 40228)	T4cmin	Default setting: 10°C, range: -5~25°C, setting interval: 1°C	
228 (PLC: 40229)	t_interval_H	Time interval of compressor start-up in the heating mode; range: 5~60 min, default setting: 5 min	
229 (PLC: 40230)	dT1SH	Default setting: 5°C, range: 2~10°C, setting interval: 1°C	
230 (PLC: 40231)	dTSH	Default setting: 2°C, range: 1~10°C, setting interval: 1°C	
231 (PLC: 40232)	T4hmax	Default setting: 25°C, range: 20~35°C, setting interval: 1°C	
232 (PLC: 40233)	T4hmin	Default setting: -15°C, range: -25~5°C, setting interval: 1°C	
233 (PLC: 40234)	T4_IBH_on	Ambient temperature for enabling the hydraulic module auxiliary electric heating IBH, range: -15~10°C; default setting: -5°C	
234 (PLC: 40235)	dT1_IBH_on	Temperature return difference for enabling the hydraulic module auxiliary electric heating IBH, range: 2~10°C; default setting: 5°C	
235 (PLC: 40236)	t_IBH_delay	Delay time of enabling the hydraulic module auxiliary electric heating IBH, range: 15~120 min; default setting: 30 min	
236 (PLC: 40237)	t_IBH12_delay	When IBH1 is enabled, the default time for enabling IBH2, range: 5~30 min, default setting: 5 min	
237 (PLC: 40238)	T4_AHS_on	Ambient temperature for enabling the external heater AHS, range: -15~10°C, setting interval: -5°C	
238 (PLC: 40239)	dT1_AHS_on	Temperature return difference for enabling the external heater AHS, range: 2~10°C; default setting: 5°C	
239 (PLC: 40240)	dT1_AHS_off	Temperature return difference for closing the external heater AHS, range: -5~0°C; default setting: 0°C	
240 (PLC: 40241)	t_AHS_delay	Delay time for enabling the external heater AHS, range: 5~120 min; default setting: 30 min	

241 (PLC: 40242)	t_DHWHP_max	Longest duration of water heating by the heat pump, range: 10~600 min, default setting: 120 min;
242 (PLC: 40243)	t_DHWHP_restrict	Duration of limited water heating by the heat pump, range: 10~600 min, default setting: 30 min;
243 (PLC: 40244)	T4autocmin	Default setting: 25°C, range: 20~29°C, setting interval: 1°C
244 (PLC: 40245)	T4autohmax	Default setting: 17°C, range: 10~17°C, setting interval: 1°C
245 (PLC: 40246)	T1S_H. A_H	In the holiday mode, setting of T1 in the heating mode, range: 20~25°C, default setting: 25°C
246 (PLC: 40247)	T5S_H. A_DHW	In the holiday mode, setting of T1 in the water heating mode, range: 20~25°C, default setting: 25°C
247 (PLC: 40248)	ECO parameter	Reserved, wrong address is reported when this register is queried
248 (PLC: 40249)	ECO parameter	Reserved, wrong address is reported when this register is queried
249 (PLC: 40250)	ECO parameter	Reserved, wrong address is reported when this register is queried
250 (P LC:40251)	ECO parameter	Reserved, wrong address is reported when this register is queried
251 (PLC: 40252)	Comfort parameter	Reserved, wrong address is reported when this register is queried
252 (P LC:40253)	Comfort parameter	Reserved, wrong address is reported when this register is queried
253 (PLC: 40254)	Comfort parameter	Reserved, wrong address is reported when this register is queried
254 (P LC:40255)	Comfort parameter	Reserved, wrong address is reported when this register is queried
255 (PLC: 40256)	t_DRYUP	Temperature rise day number, range: 4~15 days, default setting: 8 days
256 (PLC: 40257)	t_HIGHPEAK	Drying day number, range: 3~7 days, default setting: 5 days
257 (PLC: 40258)	t_DRYD	Temperature drop day number, range: 4~15 days, default setting: 5 days
258 (PLC: 40259)	T_DRYPEAK	Highest drying temperature, range: 30~55°C, default setting: 45°C
259 (PLC: 40260)	t_firstFH	Running time of floor heating for the first time, default setting: 72 hrs, range: 48-96 hrs
260 (PLC: 40261)	T1S (first floor heating)	T1S of floor heating for the first time, range: 25~35°C, default setting: 25°C

Meaning of icons



	Key lock		The compressor is activated
	At the next scheduled action, the temperature will decrease		Pump active
	The temperature not change		Weekly schedule
	The temperature will decrease		Time schedule
	The temperature will increase		Outdoor temperature
	Fan coil		Wi-Fi
	Radiator		Domestic hot water (DHS)
	Floor heating (radiant panels)		Disinfect function (anti-legionella) active
	System water supply temperature (configurable)	ON OFF	Switch on Switch off
	Ambient temperature set		DHW storage temperature
	Heating mode		Active solar panel
	Cooling mode		Active storage tank electric heater
	Automatic mode		Alarm
	Additional heat source		
	Electric heater		

Anti-freeze mode active 	Defrosting mode active 	Away / at home holiday active 	Silent mode active 	ECO mode active 
	Fan coil	Radiator	Radiant panels	DHW
ON				
OFF				

Keys

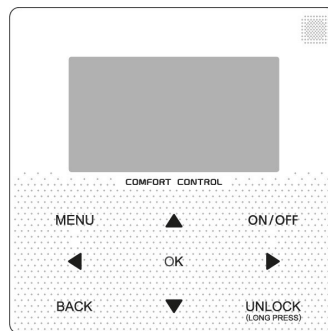

Keys	Function
MENU	Access to the menu structure (from the screen)
LEFT - RIGHT ◀▶ UP DOWN ▲▼	Moving the cursor on the display Movement within the menu structure Adjustment of parameter settings
ON/OFF	Turn on/off the space heating/cooling operation or DHW mode Turn on/or off functions in the menu structure Activation / deactivation of functions in the menu structure
BACK	Come back to the up level
UNLOCK	(Long press) Unlock / lock the control unit Unlocking / locking certain functions, such as the domestic hot water temperature control
OK	Hourly programming progress in the menu structure, confirmation of selections or access to submenus

Auto-restart function

The unit is equipped with an auto-restart function: in the event of a power failure (eg. black-out), when this is restored the unit restarts at the last settings selected.

Home pages

When you turn on the wired controller, the system will enter the language selection page, You can choose your preferred language, then press OK to enter the home pages.

If you don't press OK in 60 seconds, the system will enter in the currently selected language.



Depending on the system layout, the following home pages may be possible:

- Desired ambient temperature
- Desired water flow temperature
- Actual temperature of the domestic hot water tank (DHW)

Type 1 system diagram

The system includes the floor heating and domestic hot water function.

Type 1 home page appears

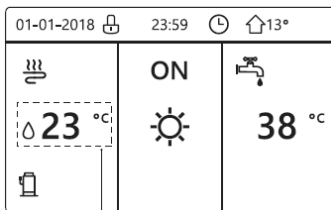

23°C= desired water flow temperature

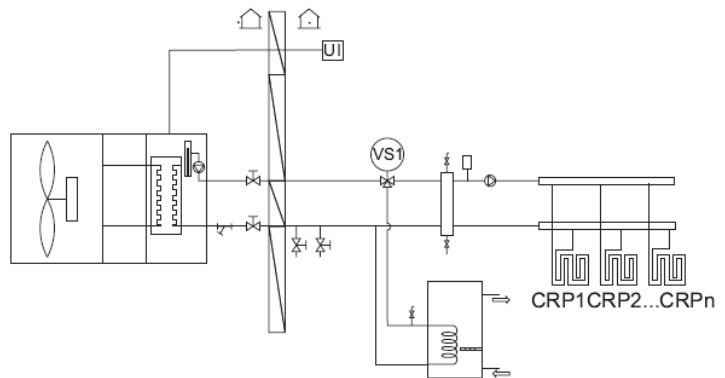

SERVICEMAN menu

Temp type setting

Temp. Water flow YES

Temp. Environment NO

Type 2 system diagram

The system includes the floor heating and domestic hot water function.
Type 2 home page appears

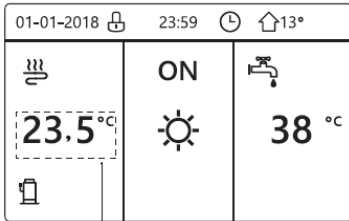

23,5°C= desired ambient temperature

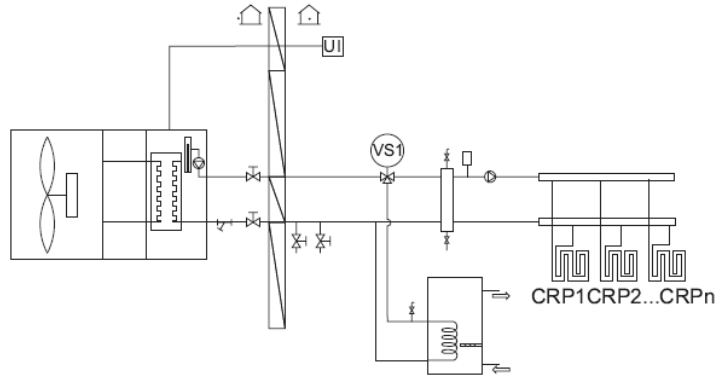

SERVICEMAN menu

Temp type setting

Temp. Water flow NO
Ambient Temp. YES

NOTE

It is necessary to install the wall-mounted control unit in the floor heating room to make it possible to control ambient temperature.

Type 3 system diagram

The system provides floor heating and ambient heating for the fan coil unit.
There is a main page and an additional one.

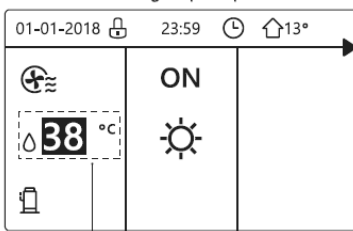

38°C= desired water flow temperature zone 1

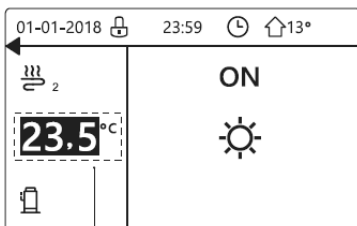

23,5°C= desired ambient temperature in zone 2

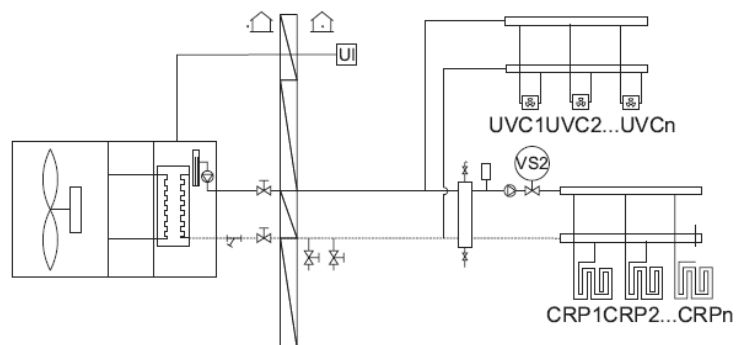

SERVICEMAN menu

Temp type setting

Temp. Water flow YES

DHW mode setting

DHW mode NO

Type 4 system diagram

The system includes the cooling, ambient cooling function for the fan coil unit and domestic hot water. There is a main page and an additional one.

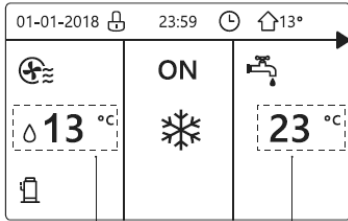

13°C= desired water flow temperature zone 1
23°C= actual DHW tank temperature

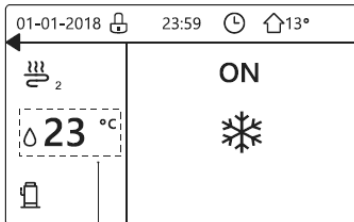

23°C= desired water flow temperature zone 2

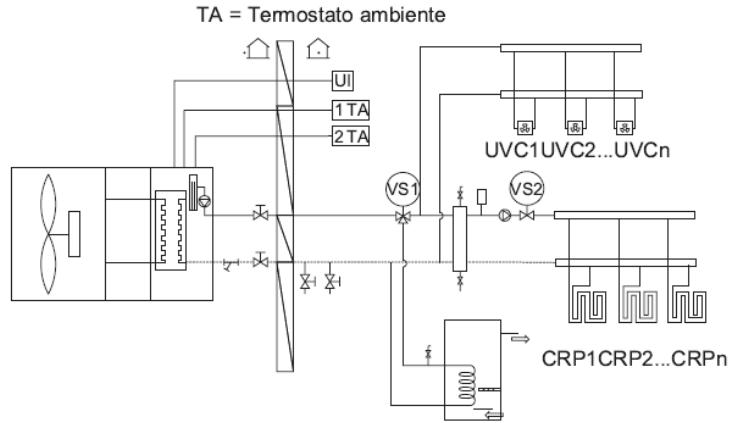

SERVICEMAN menu
Ambient thermostat
TWO ZONES YES

Menu structure

From a home page press MENU
To move use UP and DOWN

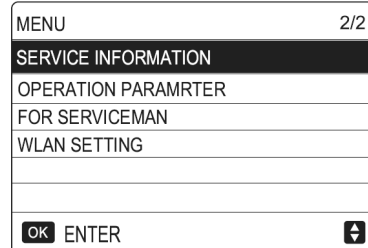
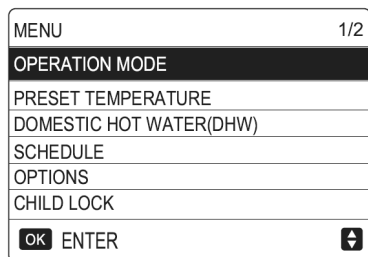

Structure menu

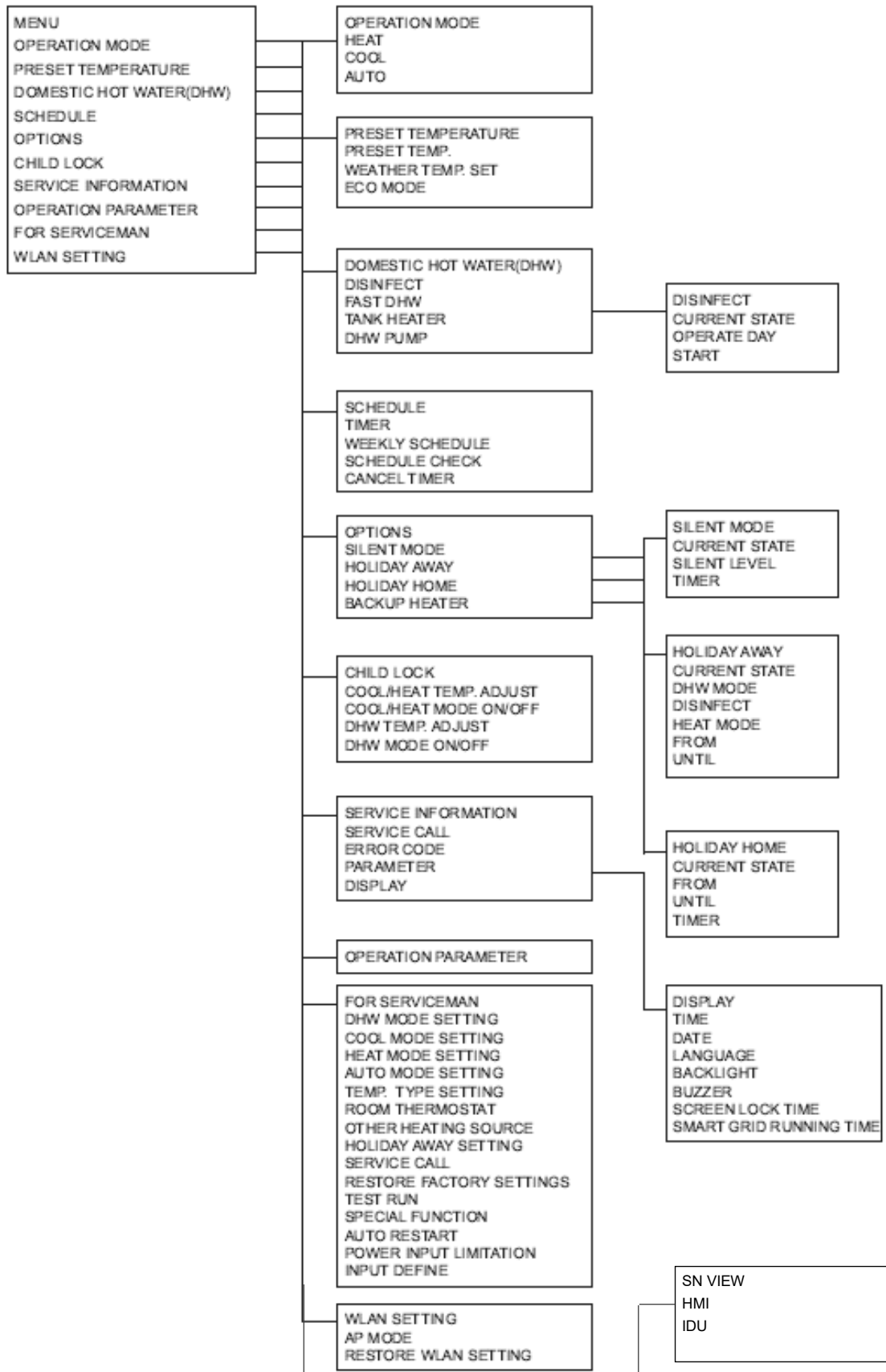

* Access by pwd is reserved to qualified personnel; The parameters changes may cause malfunctions.

Lock - unlock keyboard

If the UNLOCK icon is on the screen, the controller is locked. The following page appears

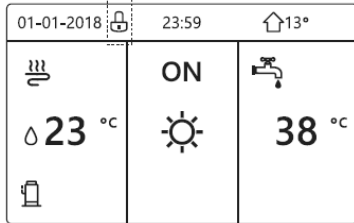

Press any key, the UNLOCK icon will flash. Long press the "UNLOCK" key. The icon will disappear, the interface can be checked. The interface will be locked if there is no handling for a long time (about 120 seconds: it can be set by the interface, see SERVICE INFORMATION).

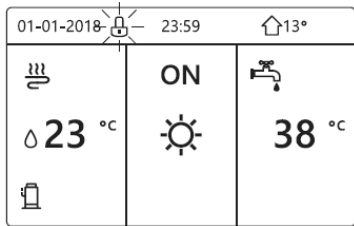

If the interface is unlocked, press and hold UNLOCK to lock it.

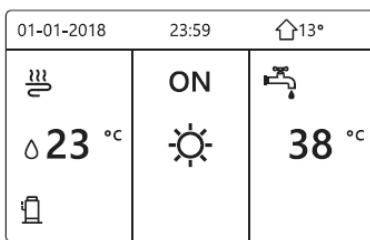

Long press UNLOCK  ↓ ↑  Long press UNLOCK

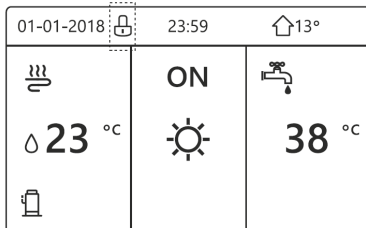

On - Off

Use the UNIT INTERFACE.

It is possible to control the activation / deactivation of the unit via the interface if AMBIENT THERMOSTAT = NO. Press LEFT and UP on the home page, the black cursor appears.

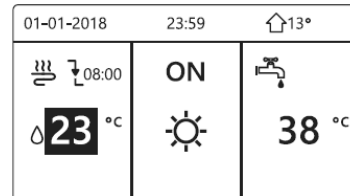

When the cursor is on the temperature of the side of the ambient operating mode (which provides for HEAT mode, COOL mode, AUTO mode), press ON-OFF to activate / deactivate space heating or cooling.

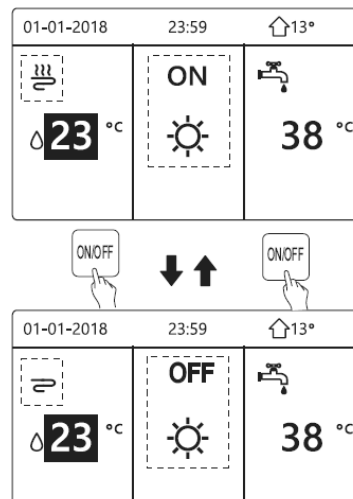

If DHW TYPE = NO, the following pages are displayed:

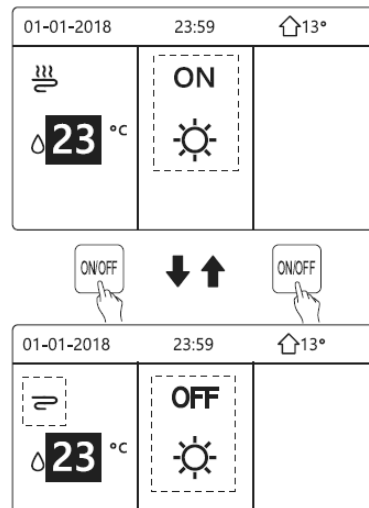

If TYPE TEMP = AMBIENT TEMP. , the following pages are displayed:

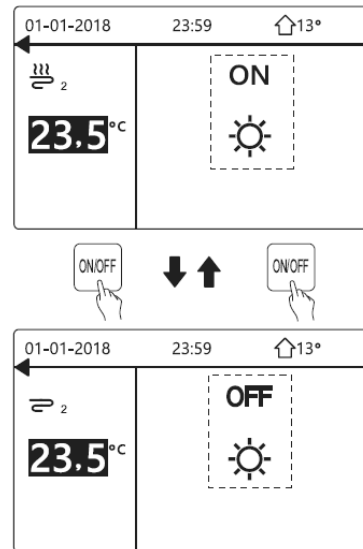
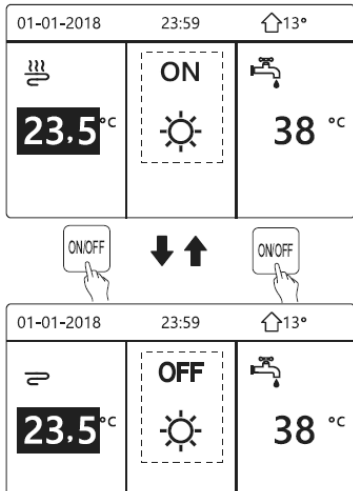

Use the AMBIENT THERMOSTAT.

1 - AMBIENT THERMOSTAT = NO.

Press LEFT and UP on the home page, the black cursor appears.

Press ON-OFF, the following page is displayed:

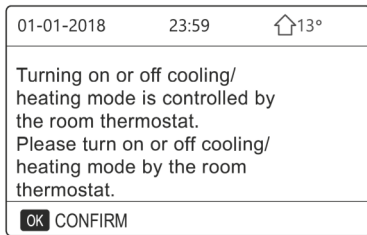

Use the interface to activate / deactivate the unit for the DHS. Press RIGHT and DOWN on the home page, the black cursor appears:

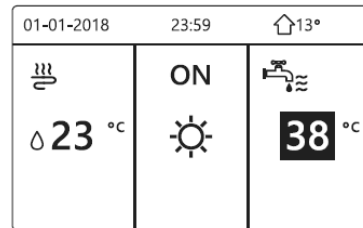

2 - AMBIENT THERMOSTAT = TWO ZONES

The ambient thermostat for the fan coil unit is deactivated, the ambient thermostat for underfloor heating is active and the unit is in operation, but the display is off.

The following page is displayed:

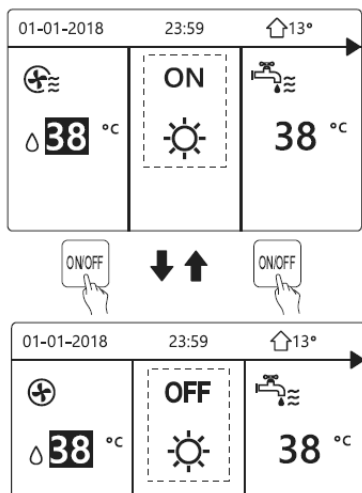

When the cursor is on the DHW mode temperature, press ON -OFF to activate / deactivate it.

If the ambient operation mode is activated (ON), the following pages are displayed:

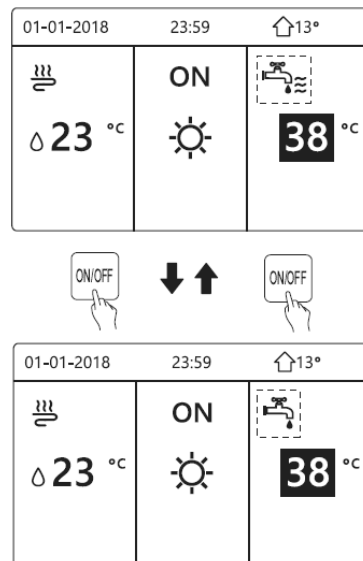

If the ambient operation mode is deactivated (OFF), the following pages are displayed:

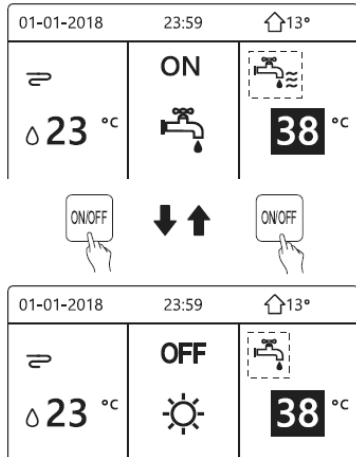

Adjusting the temperature

Press LEFT and UP on the home page, the black cursor appears.

If the cursor is on the temperature, use LEFT and RIGHT to select and use UP and DOWN to adjust the temperature.

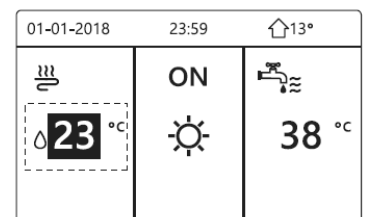
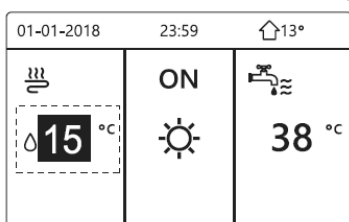
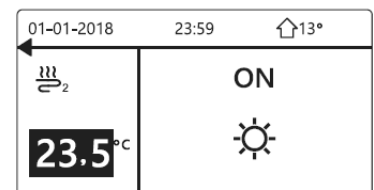
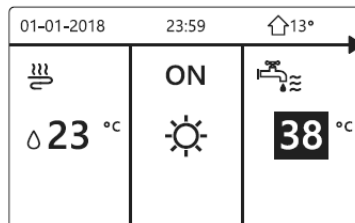
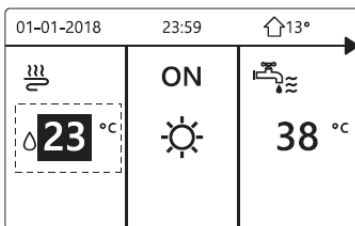
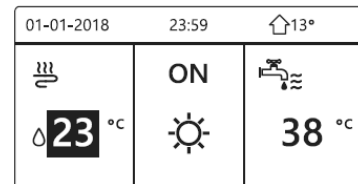

Ambient operating mode adjustment

Via INTERFACE.

Go to MENU > OPERATION MODE - OK
The following page is displayed:

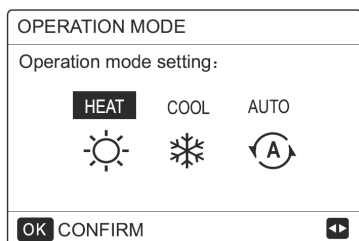

It is possible to select three modes: HEAT mode, COOL mode, AUTO mode.

Use LEFT and RIGHT to scroll, press OK to select.

If you do not press OK and exit the page using the BACK button, the mode remains active if the cursor has been moved to operating mode.

If only the HEAT (COOL) mode is available, the following page is displayed and the operation mode cannot be changed.

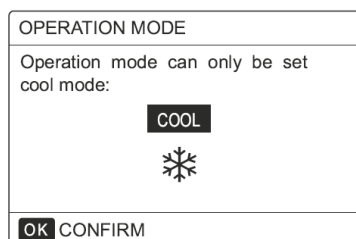
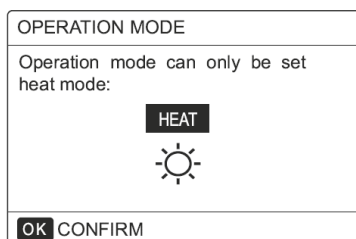

If you select	The ambient operating mode will be:
HEAT	Always HEAT mode
COOL	Always COOL mode
AUTO	Automatic modification of the setting via software based on external temperature (and the external temperature settings configured by the installer) and according to monthly limitations. Automatic modification is only possible under certain conditions

Via AMBIENT THERMOSTAT.

Go to MENU > OPERATION MODE.
If you press any key, the following page is displayed:

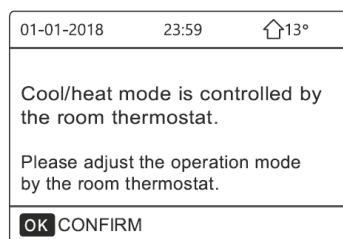

Default temperatures

The DEFAULT TEMP. function allows you to set a different temperature at a different time when the HEAT or COOL mode is active.

The function is disabled under these conditions:

- AUTO mode is active
- TIMER or WEEKLY PROGRAM Are running

Set:

MENU> DEFAULT TEMPERATURE> DEFAULT TEMP. = OK

The following page is displayed:

PRESET TEMPERATURE			1/2
PRESET TEMP.	WEATHER TEMP.SET	ECO MODE	
NO.	TIME	TEMP.	
1	<input type="checkbox"/>	00:00	25°C
2	<input type="checkbox"/>	00:00	25°C
3	<input type="checkbox"/>	00:00	25°C

PRESET TEMPERATURE			2/2
PRESET TEMP.	WEATHER TEMP.SET	ECO MODE	
NO.	TIME	TEMP.	
4	<input type="checkbox"/>	00:00	25°C
5	<input type="checkbox"/>	00:00	25°C
6	<input type="checkbox"/>	00:00	25°C

When the TWO ZONED function is activated, DEFAULT TEMP. is active only for zone 1.

Use LEFT RIGHT, UP and DOWN to scroll.
 Use UP and DOWN to adjust the time and temperature.
 When the cursor is as shown in the figure, press OK.
 Timer 1 is selected.
 Press OK again, timer 1 is deselected.

PRESET TEMPERATURE 1/2		
PRESET TEMP.	WEATHER TEMP.SET	ECO MODE
NO.	TIME	TEMP.
1	00:00	25°C
2	00:00	25°C
3	00:00	25°C
OK <input checked="" type="checkbox"/> SELECT		↔

PRESET TEMPERATURE 1/2		
PRESET TEMP.	WEATHER TEMP.SET	ECO MODE
NO.	TIME	TEMP.
1	08:00	35°C
2	12:00	25°C
3	15:00	35°C
OK <input type="checkbox"/> CANCEL		↔

Use LEFT RIGHT, UP and DOWN to scroll.
 Use UP and DOWN to adjust the time and temperature.
 Six periods and six temperatures can be set.
 For example: Now time is 8.00 and temperature is 30°C.
 Let's set the DEFAULT TEMP.as in the table below.
 The following page is displayed:

01-01-2018	8:00	13°
08:00	ON	
25 °C		

NO.	TIME	TEMPER
1	8:00	35°C
2	12:00	25°C
3	15:00	35°C
4	18:00	25°C
5	20:00	35°C
6	23:00	25°C

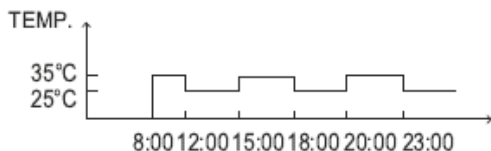

INFORMATION

When the ambient operation mode is changed, DEFAULT TEMP. switches off automatically.
 It is possible to use the DEFAULT TEMP function in HEAT or COOL mode. However, if the operating mode is changed, the DEFAULT TEMP function must be reset again .
 The current temperature is not valid when the unit is turned OFF. It activates at the next default temperature when the unit turns on again.

Weather temperature set

The SET CLIM. TEMP. function Allows you to preset the desired water flow temperature based on the outdoor air temperature.
 When the weather is warmer, the heating decreases.
 To save energy, the desired water flow temperature is decreased when the outdoor temperature increases and the HEAT mode is active.
 MENU> DEFAULT TEMPERATURES> SET CLIM. TEMP. >
 Press OK.
 The following page is displayed:

PRESET TEMPERATURE		
PRESET TEMP.	WEATHER TEMP.SET	ECO MODE
ZONE1 C-MODE LOW TEMP.		OFF
ZONE1 H-MODE LOW TEMP.		OFF
ZONE2 C-MODE LOW TEMP.		OFF
ZONE2 H-MODE LOW TEMP.		OFF
ON/OFF ON/OFF		↔

INFORMATION

SET. TEMP CLIM. has four types of curves:

1. high temperature curve for heating
2. low temperature curve for heating
3. high temperature curve for cooling
4. low temperature curve for cooling

If the high temperature for heating is set:
 it only has the high temperature setting curve for heating.

If the low temperature for heating is set:
 it only has the low temperature setting curve for heating.

And so on.

See the FOR SERVICEMAN > COOL MODE / HEAT MODE SETTING

The desired temperature T1S cannot be adjusted when the temperature curve is set to ON.

To use the HEAT mode in zone 1, select LOW HOT MODE ZONE 1 TEMP.

To use the COOL mode in zone 1 select LOW COLD MODE ZONE 1 TEMP.

If ON is selected, the following page is displayed:

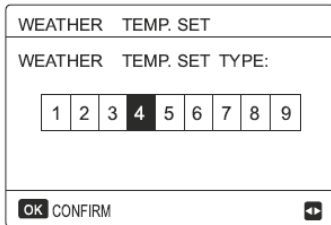

Use LEFT RIGHT to scroll.
Press OK to select.

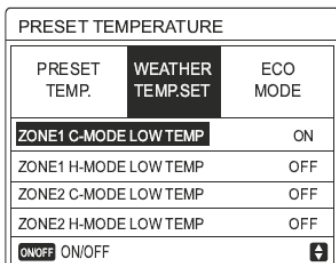

If the CLIM. TEMP SET. is activated, it is not possible to adjust the desired temperature on the interface.
Press UP DOWN to adjust the temperature on the home page.

The following page is displayed:

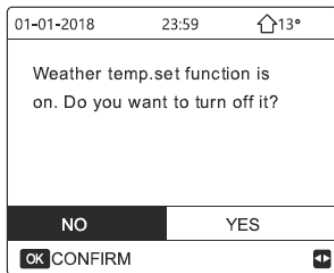

Move to NO, press OK to return to the home page Move to YES, press OK to restore CLIM. TEMP SET.

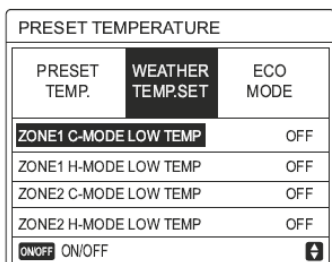

ECO mode

ECO mode saves energy.

MENU > PRESET TEMPERATURE > ECO MODE > Press OK.

The following page is displayed:

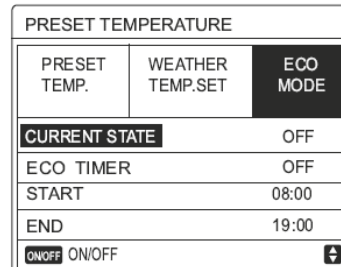

Press ON/OFF.

The following page is displayed:

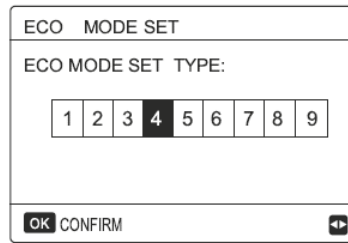

Use LEFT RIGHT to scroll.

Press OK to select.

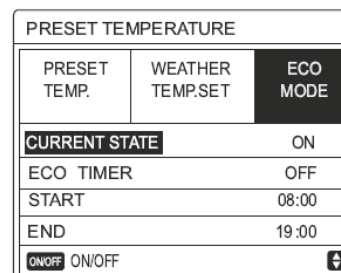

Use ON-OFF to activate / deactivate; use UP and DOWN to scroll.

When the cursor is on START or END, you can use LEFT RIGHT UP DOWN to scroll and UP DOWN to adjust the time.

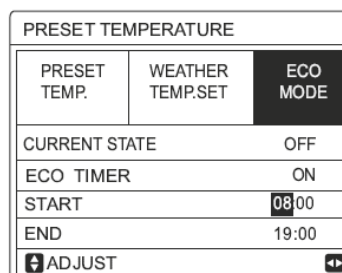

INFORMATION

SET. ECO MODE has two types of curves:

1. the high temperature setting curve for heating
2. the low temperature setting curve for heating

If the high temperature for heating is set:

it only has the high temperature setting curve for heating.

If the low temperature for heating is set:

it only has the low temperature setting curve for heating.

See the FOR SERVICEMAN > HEAT MODE SETTING

It is not possible to adjust the desired temperature T1S when the ECO mode is activated (ON)

It is possible to select the low or high temperature setting for heating: see table 1-2.

If ECO MODE is active (ON) and ECO TIMER is deactivated (OFF), the unit always operates in ECO mode.

If ECO MODE is active (ON) and ECO TIMER is activated (ON), the unit operates in ECO mode according to the start and end times.

DOMESTIC HOT WATER (DHW)			
DIS-INFECT	FAST DHW	TANK HEATER	DHW PUMP
CURRENT STATE			OFF
OPERATE DAY			FRI
START			23:00
ON/OFF ON/OFF			

Use LEFT RIGHT and UP DOWN to scroll and use UP DOWN to adjust the parameters when setting OPERATION DAY and START.

If the OPERATION DAY is set to FRIDAY AND START is set to 23:00, the disinfect function is activated on Friday, at 23:00.

If the disinfect function is active, the following page is displayed:

01-01-2018 23:59 13°		
	ON	
23.5 °C		38 °C

Domestic hot water (DHW)

Il modo ACS include i seguenti elementi:

1. **Disinfect**
2. **FAST DHW**
3. **Heated Tank**
4. **DHW pump**

Disinfect

The DISINFECT function allows you to eliminate Legionella bacteria.

In the disinfect function, the tank temperature reaches 65-70°C.

The disinfect temperature is set in DHW MODE.

See FOR SERVICEMAN. > DHW MODE > DISINFECT.

MENU > DOMESTIC HOT WATER > DISINFECT

Press OK. The following page is displayed:

DOMESTIC HOT WATER (DHW)			
DIS-INFECT	FAST DHW	TANK HEATER	DHW PUMP
CURRENT STATE			ON
OPERATE DAY			FRI
START			23:00
ON/OFF ON/OFF			



FAST DHW

The function allows you to force the system to activate DHW MODE.

The heat pump and the auxiliary or additional heater are activated together for the DHW MODE and the desired DHW temperature goes to 60 °C.

Select MENU> DOMESTIC HOT WATER> FAST DHW and press OK.

Use ON-OFF to select active (ON) or deactivated (OFF)

DOMESTIC HOT WATER (DHW)			
DIS-INFECT	FAST DHW	TANK HEATER	DHW PUMP
CURRENT STATE			ON
ON/OFF ON/OFF			



DOMESTIC HOT WATER (DHW)			
DIS-INFECT	FAST DHW	TANK HEATER	DHW PUMP
CURRENT STATE			OFF
ON/OFF ON/OFF			

INFORMATION

If CURRENT STATUS is deactivated (OFF), the FAST DHW function is not valid, while if it is active (ON) the FAST DHW function is active.

The FAST DHW function is activated once.

Tank heater

This function allows you to force heating of the water in the tank.

In the same situation, cooling or heating is required and the heat pump system is operating to produce cooling or heating. However, hot water is also required.

Furthermore, if the heat pump system is not sufficient, TANK HEATING can be used to heat the water in the tank.

Select MENU> DOMESTIC HOT WATER> TANK HEATER, press OK.

DOMESTIC HOT WATER (DHW)			
DIS-INFECT	FAST DHW	TANK HEATER	DHW PUMP
CURRENT STATE			ON
ON/OFF ON/OFF			



DOMESTIC HOT WATER (DHW)			
DIS-INFECT	FAST DHW	TANK HEATER	DHW PUMP
CURRENT STATE			OFF
ON/OFF ON/OFF			

Use ON-OFF to select active (ON) or deactivated (OFF), BACK to exit.

If TANK HEATER is active, the following page is displayed:

01-01-2018 23:59 13°		
23 °C	ON	38 °C

INFORMATION

If CURRENT STATUS is deactivated (OFF), TANK HEATER cannot be activated.

If the T5 tank sensor is in failure, the tank heater cannot work.

DHW pump

The function allows you to return the water to the water supply. Select MENU> DOMESTIC HOT WATER> DHW PUMP, press OK.

DOMESTIC HOT WATER (DHW) 1/2			
DIS-INFECT	FAST DHW	TANK HEATER	DHW PUMP
NO.	START	NO.	START
T1 <input type="checkbox"/>	00:00	T4 <input type="checkbox"/>	00:00
T2 <input type="checkbox"/>	00:00	T5 <input type="checkbox"/>	00:00
T3 <input type="checkbox"/>	00:00	T6 <input type="checkbox"/>	00:00

DOMESTIC HOT WATER (DHW) 2/2			
DIS-INFECT	FAST DHW	TANK HEATER	DHW PUMP
NO.	START	NO.	START
T7 <input type="checkbox"/>	00:00	T10 <input type="checkbox"/>	00:00
T8 <input type="checkbox"/>	00:00	T11 <input type="checkbox"/>	00:00
T9 <input type="checkbox"/>	00:00	T12 <input type="checkbox"/>	00:00

Move and press OK to select / deselect.

Use LEFT RIGHT and UP and DOWN to scroll and use UP and DOWN to adjust the parameters.

DOMESTIC HOT WATER (DHW) 1/2			
DIS-INFECT	FAST DHW	TANK HEATER	DHW PUMP
NO.	START	NO.	START
T1 <input checked="" type="checkbox"/>	00:00	T4 <input type="checkbox"/>	00:00
T2 <input type="checkbox"/>	00:00	T5 <input type="checkbox"/>	00:00
T3 <input type="checkbox"/>	00:00	T6 <input type="checkbox"/>	00:00

Example: the parameter relating to the DHW PUMP has been set (see FOR THE AFTER-SALES SERVICE> DHW MODE SETTING).

PUMP ACTIVATION TIME is 30 minutes.

The setting is the following:

NO.	START
1	6:00
2	7:00
3	8:00
4	9:00

The PUMP activates as follows:

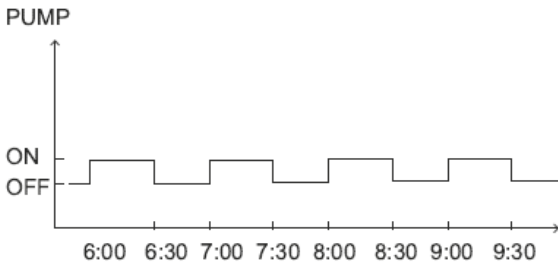

Time schedule

The PROGRAM menu. includes the following elements:

1. **TIMER**
2. **PROGRAM. WEEKLY .**
3. **CONTR. PROGRAM.**
4. **CANCEL TIMER**

TIMER

If the weekly schedule is active and the timer function is deactivated, the most recent setting is valid.

If the timer is activated, the timer icon appears on the home page.

SCHEDULE					1/2
TIMER	WEEKLY SCHEDULE	SCHEDULE CHECK	CANCEL TIMER		
NO.	START	END	MODE	TEMP	
1	<input type="checkbox"/>	00:00	00:00	HEAT	0°C
2	<input type="checkbox"/>	00:00	00:00	HEAT	0°C
3	<input type="checkbox"/>	00:00	00:00	HEAT	0°C

SCHEDULE					2/2
TIMER	WEEKLY SCHEDULE	SCHEDULE CHECK	CANCEL TIMER		
NO.	START	END	MODE	TEMP	
4	<input type="checkbox"/>	00:00	00:00	HEAT	0°C
5	<input type="checkbox"/>	00:00	00:00	HEAT	0°C
6	<input type="checkbox"/>	00:00	00:00	HEAT	0°C

Use LEFT RIGHT and UP DOWN to scroll and UP DOWN to adjust the time, mode and temperature

Use LEFT RIGHT and UP DOWN to scroll and UP DOWN to adjust the time, mode and temperature.

Move and press OK to select / deselect. 6 timers can be set.

To cancel the TIMER, move the cursor and press OK.

If the set start time is later than the end time (or if the temperature is not within mode range), the following page is displayed:

SCHEDULE			
TIMER	WEEKLY SCHEDULE	SCHEDULE CHECK	CANCEL TIMER
Timer1 is useless.			
Please check the timer setting and temperature setting.			
OK CONFIRM			

Example: 6 timers are set as follows.

The unit is activated as shown in figure

NO.	START	END	MODE	TEMP
T1	1: 00	3: 00	DHW	50°C
T2	7: 00	9: 00	HEAT	28°C
T3	11: 30	13: 00	COOL	20°C
T4	14: 00	16: 00	HEAT	28°C
T5	15: 00	19: 00	COOL	20°C
T6	18: 00	23: 30	DHW	50°C

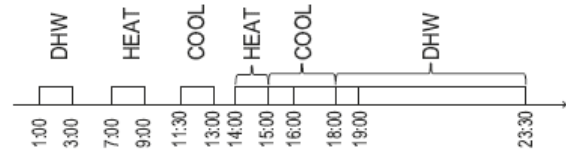

The control unit is activated as follows

TIME	The operatin of the controller
1: 00	DHW mode is turned ON
3: 00	DHW mode is turned OFF
7: 00	HEAT MODE is turned ON
9: 00	HEAT MODE is turned OFF
11: 30	COOL MODE is turned ON
13: 00	COOL MODE is turned OFF
14: 00	HEAT MODE is turned ON
15: 00	COOL MODE is turned ON and HEAT MODE is turned OFF
18: 00	DHW MODE is turned ON and COOL MODE is turned OFF
23: 30	DHW mode is turned OFF

INFORMATION

If the start and end times in a timer coincide, the timer is not valid.

Weekly schedule

If the timer function is on and the weekly schedule is off, the most recent setting is effective.

If the WEEKLY PROGRAM. is activated, the related icon appears on the home page.

Select MENU> PROGRAM. > WEEKLY PROGRAM .

Press OK

The following page is displayed

SCHEDULE						
TIMER	WEEKLY SCHEDULE	SCHEDULE CHECK	CANCLE TIMER			
MON.	TUE.	WED.	THU.	FRI.	SAT.	SUN.
<input checked="" type="checkbox"/>	<input type="checkbox"/>	<input type="checkbox"/>	<input type="checkbox"/>	<input type="checkbox"/>	<input type="checkbox"/>	<input type="checkbox"/>
ENTER			CANCEL			
OK MON SELECT						

First select the days of the week to be programmed.

Use LEFT and RIGHT to scroll, press OK to select / deselect the day.

INFORMATIN

It is necessary to set at least 2 days when the WEEKLY PROGRAM function is activated.

SCHEDULE						
TIMER	WEEKLY SCHEDULE	SCHEDULE CHECK	CANCLE TIMER			
MON.	TUE.	WED.	THU.	FRI.	SAT.	SUN.
<input type="checkbox"/>	<input type="checkbox"/>	<input type="checkbox"/>	<input type="checkbox"/>	<input checked="" type="checkbox"/>	<input type="checkbox"/>	<input type="checkbox"/>
ENTER			CANCEL			
OK MON SELECT						

Use LEFT RIGHT to set, press CONFIRM.

The days from Monday to Friday are selected, which have the same programming.

SCHEDULE						1/2
TIMER	WEEKLY SCHEDULE	SCHEDULE CHECK	CANCLE TIMER			
NO.	START	END	MODE	TEMP		
1	<input type="checkbox"/>	00:00	00:00	HEAT	0°C	
2	<input type="checkbox"/>	00:00	00:00	HEAT	0°C	
3	<input type="checkbox"/>	00:00	00:00	HEAT	0°C	

SCHEDULE						2/2
TIMER	WEEKLY SCHEDULE	SCHEDULE CHECK	CANCLE TIMER			
NO.	START	END	MODE	TEMP		
4	<input type="checkbox"/>	00:00	00:00	HEAT	0°C	
5	<input type="checkbox"/>	00:00	00:00	HEAT	0°C	
6	<input type="checkbox"/>	00:00	00:00	HEAT	0°C	

Use LEFT RIGHT and UP DOWN to scroll and adjust the time, mode and temperature.

It is possible to configure various timer settings, including start and end time, mode and temperature. HEAT mode, COOL mode and DHW mode are included.

The setting method refers to timer setting.

The end time must be later than the start time.

Otherwise, the TIMER NOT REQUIRED indication will appear, or it cannot be activated.

Programming control.

The CONTR. PROGRAM. function can only control the weekly schedule.

Select MENU> PROGRAM. > CONTR. PROGRAM.

Press OK

The following page is displayed:

Press UP DOWN, the timer from Monday to Sunday is displayed

SCHEDULE			
TIMER	WEEKLY SCHEDULE	SCHEDULE CHECK	CANCLE TIMER
WEEKLY SCHEDULE CHECK			
OK ENTER			

WEEKLY SCHEDULE CHECK					
DAY	NO	MODE	SET	START	END
MON	T1	<input type="checkbox"/>	HEAT	0°C	00:00 00:00
	T2	<input type="checkbox"/>	HEAT	0°C	00:00 00:00
	T3	<input type="checkbox"/>	HEAT	0°C	00:00 00:00
	T4	<input type="checkbox"/>	HEAT	0°C	00:00 00:00
	T5	<input type="checkbox"/>	HEAT	0°C	00:00 00:00
	T6	<input type="checkbox"/>	HEAT	0°C	00:00 00:00

Cancel timer

Select MENU> PROGRAM. > CANCEL TIMER.

Press OK

The following page is displayed:

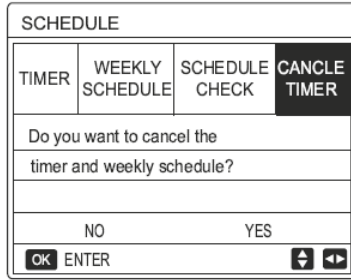

Use LEFT RIGHT and UP DOWN to move to YES, press OK to cancel the timer.

If you want to exit CANCEL TIMER, press "BACK".

If the TIMER or WEEKLY PROGRAM functions are active, the timer and weekly programming icon appear on the home page.

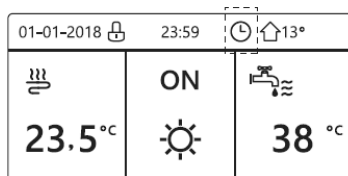

Use LEFT RIGHT and UP DOWN to move to YES, press OK to cancel the timer.

If you want to exit CANCEL TIMER, press "BACK".

If you cancel TIMER or PROGRAM. WEEKLY. The icons disappear from the main page

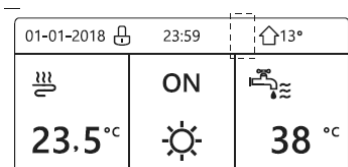

INFORMATION

WEEKLY TIMER / PROGRAM must be reset If you switch from the TEMP. WATER FLOW TEMP. to AMBIENT TEMP. or vice versa.

TIMER or WEEKLY PROGRAM. they are not valid if AMBIENT THERMOSTAT is active.

INFORMATION

- ECO MODE and COMFORT MODE have the highest priority, TIMER or WEEKLY PROGRAM . have an intermediate priority and DEFAULT TEMP. or CLIM. TEMP. SET. have the lowest priority.
- DEFAULT TEMP or CLIM. TEMP. SET. are no longer valid when setting ECO or COMFORT activation. DEFAULT TEMP or CLIM. TEMP. SET. must be reset when you deactivate ECO or COMFORT.

- TIMER or WEEKLY PROGRAM. they are not valid when ECO or COMFORT are activated. TIMER or WEEKLY PROGRAM. . they are activated when ECO or COMFORT are not in operation.
- TIMER or WEEKLY PROGRAM. have the same priority. The function with the most recent setting is valid. DEFAULT TEMP. is no longer valid when TIMER or WEEKLY PROGRAM. have no effect on CLIM. TEMP. SET
- DEFAULT TEMP and CLIM. TEMP. have the same priority. The function with the most recent setting is valid

INFORMATION

It is possible to program all the elements (DEFAULT TEMP., ECO / COMFORT, DISINFECT, DHW PUMP, TIMER, WEEKLY PROGRAM. , SILENT MODE, HOLIDAY AT HOME) by setting the relative function to ON-OFF from the start time to the end time.

Options

The OPTIONS menu includes the following items:

1. SILENT MODE
2. HOLIDAY AWAY
3. HOLIDAY AT HOME
4. BACKUP HEATER

Silent mode

The silent mode allows you to reduce unit noise.

However, this also reduces the heating / cooling capacity of the system.

Silent mode has two levels:

Level 2 has is quieter and the heating / cooling capacity is also lower.

It is possible to use silent mode in the following ways:

1. Silent mode all the time
2. Silent mode based on timer.

Go to the home page to check if silent mode is active. If the related icon appears.

Select MENU> OPTIONS> SILENT MODE

Press OK

The following page is displayed:

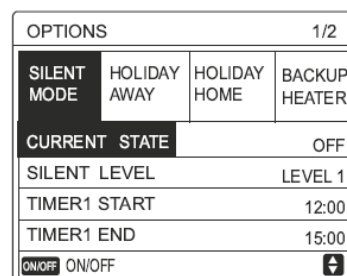

Use ON-OFF to select active (ON) or disabled (OFF).
If CURRENT STATUS is set to OFF, SILENT MODE is invalid.

When you select SILENCE LEVEL and press OK or RIGHT, the following page is displayed:

OPTIONS			
SILENT MODE	HOLIDAY AWAY	HOLIDAY HOME	BACKUP HEATER
CURRENT STATE			ON
SILENT LEVEL			LEVEL 1
TIMER1 START			12:00
TIMER1 END			15:00
ADJUST			

LEVEL 1

OPTIONS			
SILENT MODE	HOLIDAY AWAY	HOLIDAY HOME	BACKUP HEATER
CURRENT STATE			ON
SILENT LEVEL			LEVEL 2
TIMER1 START			12:00
TIMER1 END			15:00
ADJUST			

LEVEL 2

UP and DOWN can be used to select level 1 or level 2. Press OK.

If silent TIMER is selected, press OK to access.

The following page is displayed:

OPTIONS			
SILENT MODE	HOLIDAY AWAY	HOLIDAY HOME	BACKUP HEATER
TIMER1			OFF
TIMER2 START			22:00
TIMER2 END			07:00
TIMER2			OFF
ADJUST			

It is possible to set two timers.

Move and press OK to select / deselect.

If both timers are deselected, the silent mode always remains active.

Otherwise the operation takes place based on the time.

Holiday away.

If the Holiday away mode is active, the corresponding icon appears on the home page.

The Holiday away function allows you to keep the house from freezing in the winter when you are away for the holidays and to reactivate the unit before the end of the holidays.

Go to MENU > OPTIONS > HOLIDAY AWAY.

Press OK.

The following page is displayed:

OPTIONS			
SILENT MODE	HOLIDAY AWAY	HOLIDAY HOME	BACKUP HEATER
CURRENT STATE			OFF
DHW MODE			ON
DISINFECT			ON
HEAT MODE			ON
ON/OFF ON/OFF			

OPTIONS			
SILENT MODE	HOLIDAY AWAY	HOLIDAY HOME	BACKUP HEATER
FROM			00-00-2000
UNTIL			00-00-2000
ADJUST			

Example:

- in two days we leave for 2 weeks during the winter.
- today is 31/01/18 and 02/02/18 the holidays begin.
- you want to save energy, but to make sure the house does not freeze.

Go to MENU > OPTIONS > HOLIDAY AWAY.

Press OK.

Use ON-OFF to select activated (ON), deactivated (OFF) and use LEFT RIGHT UP DOWN to scroll and adjust,

Setting	Value
Holiday away	ON
From	2 February 2018
Until	16 February 2018
Operation mode	Heating
disinfect	ON

INFORMATION

- If the DHW mode is activated in the Holiday away mode, the disinfect function set by the user is not valid.
- If the holiday away mode is active, the timer and the weekly schedule are not valid unless the mode is deactivated.
- If CURRENT STATUS is deactivated (OFF), HOLIDAY AWAY is disabled (OFF).
- If CURRENT STATUS is activated (ON), HOLIDAY AWAY is activated (ON).

INFORMATION

- The remote control does not accept commands when holiday away mode is active (ON).
- Unit disinfecting is completed at 23:00 on the last day, if the related function is activated.
- When the Holiday away mode is active, the previously set climatic curves are invalid and will automatically take effect at the end of the set away Holiday period.
- The default temperature is not valid when Holiday away mode is active, but the default value still appears on the main page.

Holiday at home

The holiday at home function allows you to apply changes to normal schedules without having to change them when you spend your holidays at home,

Period	Then...
Before and after your holiday	Your normal schedules will be used.
During your holiday	The configured holiday settings will be used.

If Holiday at home mode is active, the home icon appears on the home page.

Select MENU> OPTIONS> HOLIDAY AT HOME

Press OK.

The following page is displayed:

OPTIONS			
SILENT MODE	HOLIDAY AWAY	HOLIDAY HOME	BACKUP HEATER
CURRENT STATE			OFF
FROM		00-00-2000	
UNTIL		00-00-2000	
TIMER		ENTER	
ON/OFF		ON/OFF	

Use ON-OFF to select active (ON) or disabled (OFF) and use LEFT RIGHT UP DOWN to scroll and adjust.

If CURRENT STATUS is deactivated (OFF), HOLIDAY AT HOME is deactivated (OFF).

If CURRENT STATUS is active (ON), HOLIDAY HOME is activated (ON).

Use UP DOWN to adjust the date.

- Before and after the holiday, normal schedule will be active.
- During the holiday, you save energy and prevent the house from freezing.

INFORMATION

It is necessary to restore Holiday away or Holiday at home if the operating mode of the unit is changed.

Backup heater.

The function allows you to force activation of the backup heater.

Go to MENU > OPTIONS > BACKUP HEATER.

Press OK.

If IBH and AHS are not set as valid by the DIP switch on the main control panel of the hydraulic module, the following page is displayed:

OPTIONS			
SILENT MODE	HOLIDAY AWAY	HOLIDAY HOME	BACKUP HEATER

IBH: backup heater for indoor unit

AHS= Additional heating source

If IBH and AHS are set as valid, the following page is displayed:

OPTIONS			
SILENT MODE	HOLIDAY AWAY	HOLIDAY HOME	BACKUP HEATER
BACKUP HEATER			ON
ON/OFF		ON/OFF	

Use ON-OFF to select active (ON), deactivated (OFF)

INFORMATION

- If automatic operation mode is set on the ambient heating or cooling side, the backup heater function cannot be selected.
- The BACKUP HEAT function is not valid when only the AMBIENT HEAT MODE is active.

Child lock

This function allows you to prevent children from using the unit incorrectly.

It is possible to lock or unlock the setting of the modes and control temperature regulation using the CHILD LOCK function.

Select MENU> CHILD LOCK.

The following page is displayed:

Enter your current password.

Use UP DOWN to scroll and ON-OFF to select LOCK, UNLOCK.

It is not possible to adjust the cooling / heating temperature when the TEMP ADJ. COOL / HEAT is locked.

If you want to adjust the cooling / heating temperature when it is locked, the following page is displayed:

It is not possible to activate or deactivate ON / OFF COOL / HEAT MODE when the function is blocked.

If you want to activate or deactivate COOL / HEAT MODE ON-OFF when the function is locked, the following page is displayed:

It is not possible to adjust DHW temperature when the DHW TEMP ADJ. is locked.

If you want to adjust DHW temperature when the DHW TEMP ADJ. is locked, the following page is displayed:

It is not possible to activate or deactivate the DHW mode when the ON-OFF DHW MODE function is locked.

If you want to activate or deactivate the DHW mode when the DHW MODE ON-OFF function is locked, the following page is displayed:

Service information.

The menu includes the following items:

1. SERVICE CALL
2. ERROR CODE
3. PARAMETERS
4. VIEW

How to access the menu

How to access the menu

Select MENU> SERVICE INFORMATION.

Press OK

The following page is displayed:

Service call can contain a phone or mobile phone number.

The installer can enter a phone number.

See FOR SERVICEMAN.

SERVICE INFORMATION			
SERVICE CALL	ERROR CODE	PARAMETER	DISPLAY
PHONE NO.	0000000000000		
MOBILE NO.	0000000000000		
⏪ ⏩			

The error code indicates when a fault or problem occurs and shows the meaning of the error code.

Press OK and the following page is displayed.

SERVICE INFORMATION			
SERVICE CALL	ERROR CODE	PARAMETER	DISPLAY
E2	14:10	01-01-2018	
E2	14:00	01-01-2018	
E2	13:50	01-01-2018	
E2	13:20	01-01-2018	
OK ENTER ⏪ ⏩			

SERVICE INFORMATION 1/2			
SERVICE CALL	ERROR CODE	PARAMETER	DISPLAY
E2	14:10	01-01-2018	
E2	14:00	01-01-2018	
E2	13:50	01-01-2018	
E2	13:20	01-01-2018	
OK ENTER ⏪ ⏩			

Press OK to show the meaning of the error code.

01-01-2018	23:59	🏠13°
E2 communication fault between controller and indoor unit		
Please contact your dealer.		
OK CONFIRM		

INFORMATION

It is possible to record a maximum of 8 error codes

The parameter function allows you to view the main parameters.

Two parameter pages are available:

SERVICE INFORMATION 1/2			
SERVICE CALL	ERROR CODE	PARAMETER	DISPLAY
ROOM SET TEMP.			26°C
MAIN SET TEMP.			55°C
TANK SET TEMP.			55°C
ROOM ACTUAL TEMP.			24°C

SERVICE INFORMATION 2/2			
SERVICE CALL	ERROR CODE	PARAMETER	DISPLAY
MAIN ACTUAL TEMP.			26°C
TANK ACTUAL TEMP.			55°C
SMART GRID RUNNING TIME			0 Hrs

The DISPLAY function is used to set the interface.

Use OK to access and LEFT RIGHT UP DOWN to scroll.

SERVICE INFORMATION 1/2			
SERVICE CALL	ERROR CODE	PARAMETER	DISPLAY
TIME			12:30
DATE			08-08-2018
LANGUAGE			EN
BACKLIGHT			ON
OK ENTER ⏪ ⏩			

SERVICE INFORMATION 2/2			
SERVICE CALL	ERROR CODE	PARAMETER	DISPLAY
BUZZER			ON
SCREEN LOCK TIME			120SEC
SMART GRID RUNNING TIME			2 Hrs
ON/OFF ON/OFF ⏪ ⏩			

Operation Parameter

This menu is reserved for the installer or the service technician who checks the operating parameters.

Select MENU> OPERATING PARAMETERS

Press OK.

There are 6 pages relating to the operating parameters.

Use UP DOWN to scroll.

OPERATION PARAMETER	1/6
OPERATE MODE	COOL
CURRENT	12 A
COMPRESSOR FREQUENCY	24 Hz
COMP. RUN TIME1	54 MIN
COMP. RUN TIME2	65 MIN
COMP. RUN TIME3	10 MIN

OPERATION PARAMETER	2/6
COMP. RUN TIME4	1000 HOUR
EXPANSION VALVE	240 P
FAN SPEED	600 R/MIN
IDU TARGET FREQUENCY	0 HZ
FREQUENCY LIMITED TYPE	0
T1 LEAVING WATER TEMP.	25 °C

OPERATION PARAMETER	3/6
T1B CIRCUIT2 WATER TEMP.	30 °C
T2 PLATE F-OUT TEMP.	30 °C
T2B PLATE F-IN TEMP.	45 °C
T3 OUTDOOR EXCHANGE TEMP.	-7 °C
T4 OUTDOOR AIR TEMP.	-7 °C
T5 WATER TANK TEMP.	-7 °C

OPERATION PARAMETER	4/6
Ta ROOM TEMP.	25 °C
Th COMP. SUCTION TEMP.	25 °C
Tp COMP. DISCHARGE TEMP.	25 °C
TW-O PLATE W-OUTLET TEMP.	25 °C
TW-I PLATE W-INLET TEMP.	25 °C
P1 COMP. PRESSURE1	200 kPa

OPERATION PARAMETER	5/6
T1S' C1 CLI. CURVE TEMP.	25 °C
T1S2' C2 CLI. CURVE TEMP.	25 °C
TF MODULE TEMP.	55 °C
SUPPLY VOLTAGE	230 V
POWER CONSUM.	1000 KWh
DC GENERATRIX VOLTAGE	420 V

OPERATION PARAMETER	6/6
DC GENERATRIX CURRENT	18 A
WATER FLOW	1.72 M3/H
HEAT PUMP CAPACITY	11.52 KW
HMI SOFTWARE	00-00-2000V00
IDU SOFTWARE	00-00-2000V00
ODU SOFTWARE	00-00-2000V00

INFORMATION

Entering the energy consumption parameter is optional.

Parameters not activated in the system are marked with "--".

The capacity of the heat pump is indicated only as a reference and should not be used to evaluate the unit efficiency.

Sensor accuracy is ± 1 ° C.

The flow rate parameters are calculated based on pump operating parameters.

The deviation changes according to flow speed.

The maximum deviation is 15%.

For the serviceman.

This menu is reserved for the installer or the service technician.

Select MENU> FOR SERVICEMAN.

Press OK.

Home users must NOT change the settings using this menu.

For this reason, a password has been set which prevents unauthorized access to the service settings.

The password is 234

FOR SERVICEMAN
PLEASE INPUT PASSWORD:
2 3 4
OK ENTER ADJUST

How to exit the FOR SERVICEMAN menu.

If all the parameters have been set, press BACK.

The following page is displayed:

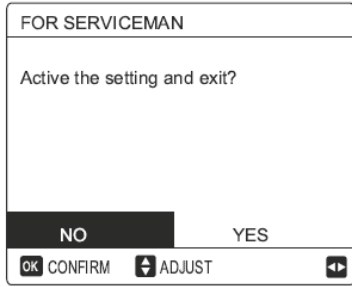

Select YES and press OK to exit the menu.
After exiting the menu, the unit turns off.

Network configurations.

- The keyboard has an intelligent control system based on a built-in module, which receives control signal from the APP.
- Before connecting to the WLAN, check if your router is active and make sure that the control unit is connected correctly to receive the wireless signal.
- During the wireless connection process, the related icon flashes to indicate that network implementation is in progress.

At the end of the process, the icon always remains on.

Setting the wall control.

The parameters of the wall control include the settings for PA MODE and RESET WLAN SETTINGS.

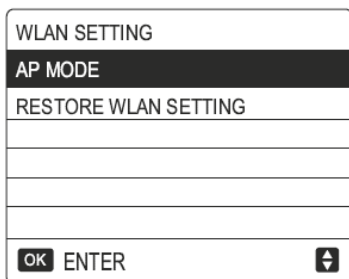

Activate the WLAN interface.
Select MENU> WLAN SETUP> PA MODE
Press OK.
The following page is displayed:

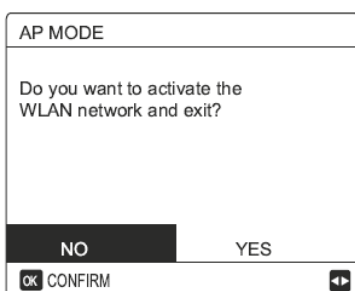

Use LEFT RIGHT to move to YES.
Press "OK" to select PA MODE.
Select the corresponding PA Mode on the mobile device and continue with subsequent settings based on APP instructions.

CAUTION

After accessing PA Mode, if connection with the mobile phone has not been established, the Wifi icon flashes for 10 minutes, then disappears.
If connection with the mobile phone has been established, the icon is always displayed.

Reset the WLAN setting using the interface.
Select MENU> WLAN SETUP> RESTORE WLAN SETTINGS.
Press OK.
The following page is displayed:

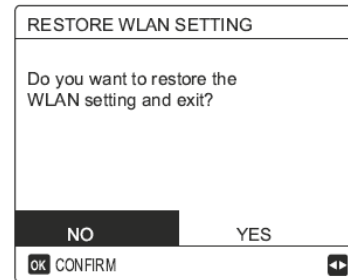

Use LEFT RIGHT to move to YES.
Press OK to restore the WLAN setting.
At this point, the wireless configuration has been restored.

Mobile device setting.

PA Mode is available for wireless connection at the mobile device level.

The APP must be installed.

Scan the following QR code to install the Smart Home APP or

Search for MSmartLife in the APP store or GOOGLE PLAY to install the APP.

1. Log in / register
Click on the + button on the right on the home page, register the account following the instructions in the guide.



Adding home equipment.

1. Choose the control unit model, then add the device
2. Configure the control unit following APP instructions.

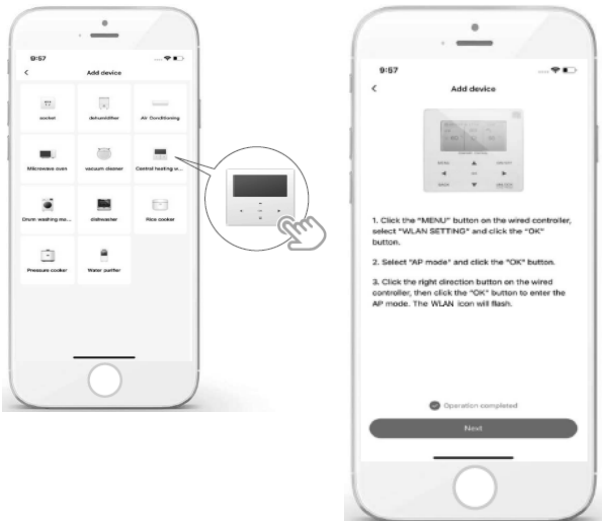

3. Wait for the home appliance to connect, then click on COMPLETE.
4. When the home appliance is connected, the WiFi icon of the control unit always remains on and it is possible to control the air conditioner via the APP.
5. If the network connection process fails or if you need to re-establish and replace the mobile connection, factory reset the WLAN on the control unit and then repeat the previous procedure.

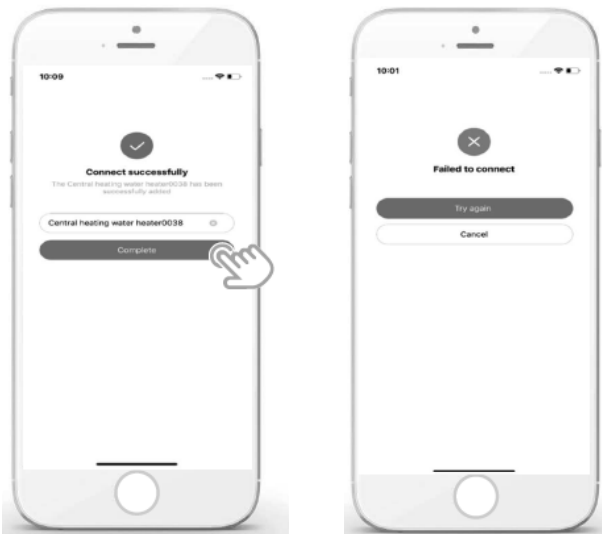

WARNING

Troubleshooting for networking failures.

- When connecting the product to the network, make sure that the phone is in close proximity to the product.
- Currently only routers with 2.4 GHz band are supported.
- We do not recommend using special characters (punctuation marks, spaces, etc.) in the name of the WLAN.
- It is preferable not to connect more than 10 devices to a single router since home appliances are affected by weak or unstable signals.
- If you change the password of the router or WLAN, delete all the settings and reset the appliances.
- The contents of the APP may undergo changes as a result of version updates and in this case this will be based on actual operation.

SN view

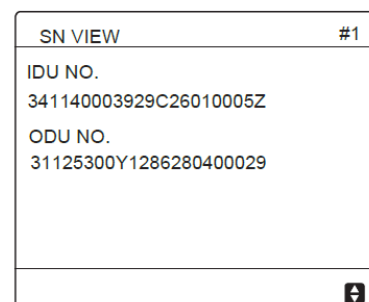
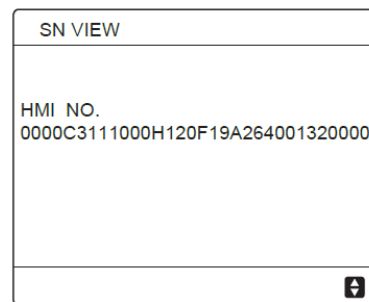

13 CONTROLLER NAVIGATION MENU

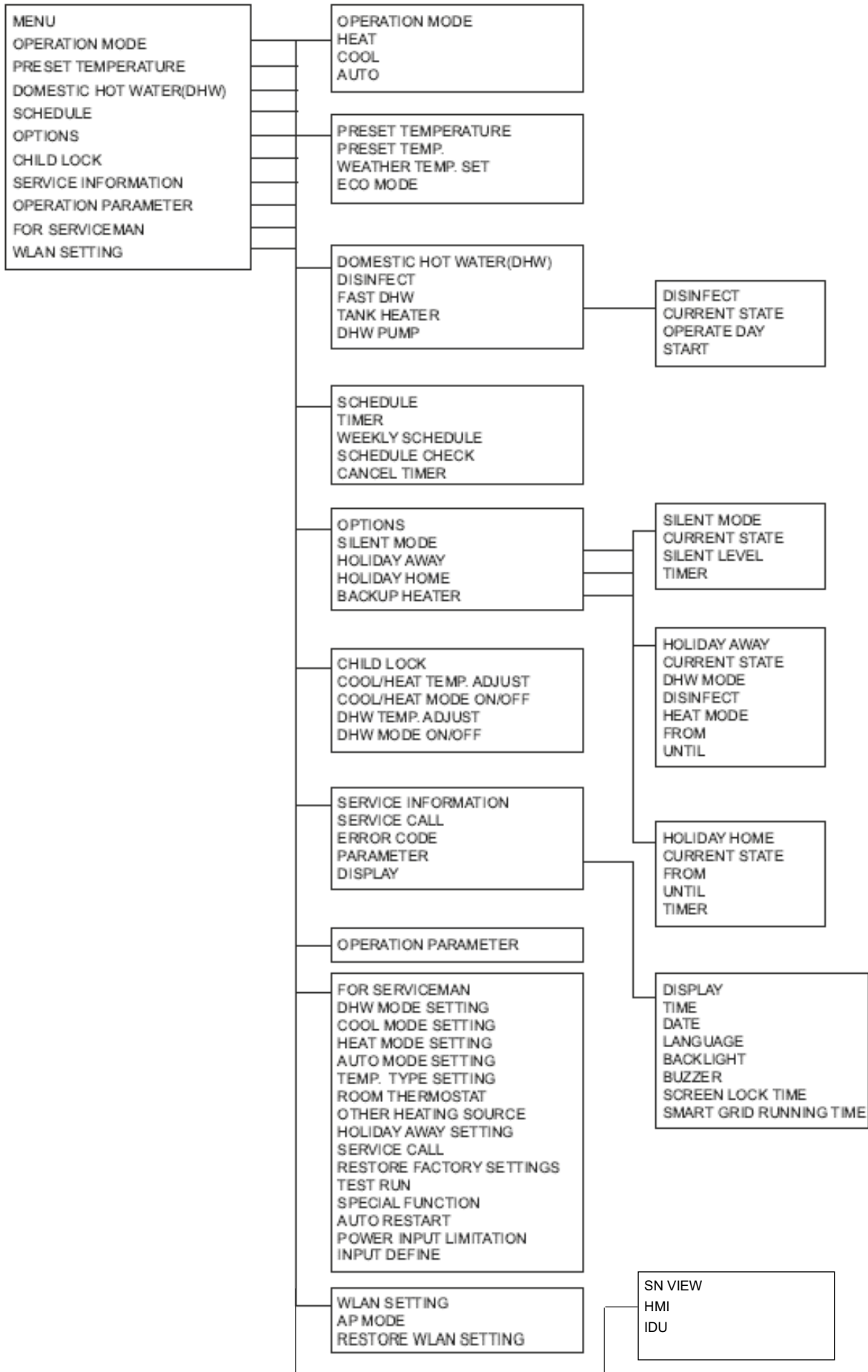

FOR SERVICEMAN
 1 DHW MODE SETTING
 2 COOL MODE SETTING
 3 HEAT MODE SETTING
 4 AUTO MODE SETTING
 5 TEMP. TYPE SETTING
 6 ROOM THERMOSTAT
 7 OTHER HEATING SOURCE
 8 HOLIDAY AWAY SETTING
 9 SERVICE CALL
 10 RESTORE FACTORY SETTINGS
 11 TEST RUN
 12 SPECIAL FUNCTION
 13 AUTO RESTART
 14 POWER INPUT LIMITATION
 15 INPUT DEFINE

2 COOL MODE SETTING
 2.1 COOL MODE
 2.2 t_{T4_FRESH_C}
 2.3 T4CMAX
 2.4 T4CMIN
 2.5 dT1SC
 2.6 dTSC
 2.7 t_{INTERVAL_C}
 2.8 T1SetC1
 2.9 T1SetC2
 2.10 T4C1
 2.11 T4C2
 2.12 ZONE1 C-EMISSION
 2.13 ZONE2 C-EMISSION

1 DHW MODE SETTING
 1.1 DHW MODE
 1.2 DISINFECT
 1.3 DHW PRIORITY
 1.4 DHW PUMP
 1.5 DHW PRIORITY TIME SET
 1.6 dT5_ON
 1.7 dT1S5
 1.8 T4DHWMAX
 1.9 T4DHWMIN
 1.10 t_{INTERVAL_DHW}
 1.11 dT5_TBH_OFF
 1.12 T4_TBH_ON
 1.13 t_{TBH_DELAY}
 1.14 T5S_DI
 1.15 t_{DI_HIGHTEMP}
 1.16 t_{DI_MAX}
 1.17 t_{DHWHP_RESTRICT}
 1.18 t_{DHWHP_MAX}
 1.19 DHW PUMP TIME RUN
 1.20 PUMP RUNNING TIME
 1.21 DHW PUMP DI RUN

4 AUTO MODE SETTING
 4.1 T4AUTOCMIN
 4.2 T4AUTOHMAX

3 HEAT MODE SETTING
 3.1 HEAT MODE
 3.2 t_{T4_FRESH_H}
 3.3 T4HMAX
 3.4 T4HMIN
 3.5 dT1SH
 3.6 dTSH
 3.7 t_{INTERVAL_H}
 3.8 T1SetH1
 3.9 T1SetH2
 3.10 T4H1
 3.11 T4H2
 3.12 ZONE1 H-EMISSION
 3.13 ZONE2 H-EMISSION
 3.14 t_{DELAY_PUMPI}

5 TEMP. TYPE SETTING
 5.1 WATER FLOW TEMP.
 5.2 ROOM TEMP.
 5.3 DOUBLE ZONE

6 ROOM THERMOSTAT
 6.1 ROOM THERMOSTAT

7 OTHER HEATING SOURCE
 7.1 dT1_IBH_ON
 7.2 t_{IBH_DELAY}
 7.3 T4_IBH_ON
 7.4 dT1_AHS_ON
 7.5 t_{AHS_DELAY}
 7.6 T4_AHS_ON

8 HOLIDAY AWAY SETTING
 8.1 T1S_H.A._H
 8.2 T5S_H.A._DHW

9 SERVICE CALL
 PHONE NO.
 MOBILE NO.

10 RESTORE FACTORY SETTINGS

11 TEST RUN

12 SPECIAL FUNCTION

13 AUTO RESTART
 13.1 COOL/HEAT MODE
 13.2 DHW MODE

14 POWER INPUT LIMITATION
 14.1 POWER LIMITATION

15 INPUT DEFINE
 15.1 ON/OFF REMOTE
 15.2 SMART GRID
 15.3 T1B (Tw2)
 15.4 Ta
 15.5 Ta:adj

14 - General technical data

Performance

SIZE		21	31	41	61	71	81	61	71	81	
Power supply		230/1/50						400/3/50+N			
Radiant panels											
Heating											
Heating capacity (EN 14511:2018)	1,9	kW	4,65	6,65	8,60	12,3	14,1	16,3	12,3	14,1	16,3
Total power input (EN 14511:2018)	1	kW	0,93	1,35	1,87	2,56	3,07	3,66	2,54	3,05	3,63
COP (EN 14511:2018)	2		5,00	4,94	4,60	4,81	4,60	4,45	4,84	4,63	4,49
ErP Space Heating Energy Class - AVERAGE Climate - W35	8,11		A+++	A+++	A+++	A++	A++	A++	A++	A++	A++
SCOP - AVERAGE Climate - W35	10		4,48	4,49	4,51	4,30	4,35	4,30	4,30	4,35	4,30
Cooling											
Cooling capacity (EN 14511:2018)	5,9	kW	4,60	6,45	8,00	12,2	14,0	15,5	12,2	14,0	15,5
Total power input (EN 14511:2018)	5	kW	0,95	1,39	1,92	2,55	3,10	3,64	2,53	3,11	3,63
EER (EN 14511:2013)	6		4,82	4,65	4,16	4,78	4,52	4,26	4,83	4,50	4,27
Water flow-rate	5	l/s	0,22	0,31	0,38	0,58	0,67	0,74	0,58	0,67	0,74
Useful pump discharge head	5	kPa	61,4	49,5	37,6	40,9	29,5	19,6	40,9	29,5	19,6
Terminal unit											
Heating											
Heating capacity (EN 14511:2018)	3	kW	4,80	6,70	8,60	12,4	14,1	16,2	12,4	14,1	16,2
Total power input (EN 14511:2018)	3	kW	1,33	1,88	2,50	3,52	4,06	4,72	3,45	3,99	4,70
COP (EN 14511:2018)	2		3,60	3,57	3,44	3,53	3,47	3,43	3,59	3,54	3,45
Cooling											
Cooling capacity (EN 14511:2018)	7	kW	4,85	6,30	7,95	10,9	12,9	13,8	10,9	12,9	13,8
Total power input (EN 14511:2018)	7	kW	1,63	2,27	3,15	3,74	4,64	5,21	3,72	4,62	5,19
EER (EN 14511:2018)	6		2,98	2,77	2,53	2,92	2,78	2,65	2,93	2,80	2,66
SEER	10		4,71	4,99	4,92	4,85	4,73	4,54	4,85	4,73	4,54
Water flow-rate	7	l/s	0,23	0,30	0,35	0,52	0,62	0,66	0,52	0,62	0,66
Useful pump discharge head	7	kPa	60,6	50,7	37,8	49,7	36,4	30,7	49,7	36,4	30,7
Radiators											
Heating											
Heating capacity (EN 14511:2018)	4	kW	4,65	6,8	8,6	11,9	14,2	16,1	11,9	14,2	16,1
Total power input (EN 14511:2018)	4	kW	1,77	2,42	3,13	4,28	5,16	5,9	4,23	5,09	5,83
COP (EN 14511:2018)	2		2,63	2,81	2,75	2,78	2,75	2,73	2,81	2,79	2,76
ErP Space Heating Energy Class - AVERAGE Climate - W55	8		A++	A++	A++	A++	A++	A++	A++	A++	A++
SCOP - AVERAGE Climate - W55	10		3,23	3,24	3,22	3,23	3,26	3,27	3,23	3,26	3,27
Water flow-rate	4	l/s	0,14	0,20	0,26	0,36	0,42	0,48	0,36	0,42	0,48
Useful pump discharge head	4	kPa	65,4	62,5	56,7	72,7	63,4	55,5	72,7	63,4	55,5

The Product is compliant with the Erp (Energy Related Products) European Directive. It includes the Commission delegated Regulation (EU) No 811/2013 (rate heat output ≤70 kW at specified reference conditions) and the Commission delegated Regulation (EU) No 813/2013 (rated heat output ≤400 kW at specified reference conditions).

Contains fluorinated greenhouse gases(GWP 675).

1. Entering/leaving water temperature user side 30/35 °C, Entering external exchanger air temperature 7 °C (R.H. = 85%).
2. COP (EN 14511:2018) Heating performance coefficient. Ratio between delivered heating capacity and power input in compliance with EN 14511:2018.
3. Entering/leaving water temperature user side 40/45 °C, Entering external exchanger air temperature 7 °C (R.H. = 85%).
4. Entering/leaving water temperature user side 47/55 °C, Entering external exchanger air temperature 7 °C (R.H. = 85%).
5. Entering/leaving water temperature user side 23/18 °C, Entering external exchanger air temperature 35 °C.
6. EER (EN 14511:2018) cooling performance coefficient. Ratio between delivered cooling capacity and power input in compliance with EN 14511:2018.
7. User side entering/leaving water temperature 12/7 °C, external exchanger entering air 35°C.
8. Seasonal Space Heating Energy Efficiency Class according to Commission delegated Regulation (EU) No 811/2013. W = Water outlet temperature (°C).
9. Data referred to unit operation with inverter frequency optimized for this application.
10. Data calculated according to the EN 14825:2016 Regulation.
11. *Energy efficiency class A+++ (range from A+++ to D) will be available from September 26th 2019; therefore, until that date the class A++ (range from A++ to G) must be considered as current standard.

Construction

SIZE		21	31	41	61	71	81	61	71	81
Power supply		230/1/50						400/3/50+N		
Compressor										
Type of compressors		Rotary Inverter DC						Rotary Inverter DC		
Refrigerant		R32						R32		
No. of compressors	Nr	1	1	1	1	1	1	1	1	1
Oil charge	l	0,46	0,46	0,46	1,1	1,1	1,1	1,1	1,1	1,1
Refrigerant Charge	kg	2	2	2	2,8	2,8	2,8	2,8	2,8	2,8
User side exchanger										
Type of internal exchanger	1	PHE								
Water content	l	0,7	0,7	0,7	1,01	1,01	1,01	1,01	1,01	1,01
External Section Fans										
Type of fans		Brushless DC motor						Brushless DC motor		
No. of fans	Nr	1	1	1	2	2	2	2	2	2
Standard airflow	m ³ /h	850	850	850	1710	1710	1710	1710	1710	1710
Installed total power	kW	0,094	0,094	0,094	0,226	0,226	0,226	0,226	0,226	0,226
Water circuit										
Maximum water side pressure	kPa	300	300	300	300	300	300	300	300	300
Safety valve calibration	kPa	300	300	300	300	300	300	300	300	300
Minimum circuit water volume	l	20	20	20	40	40	40	40	40	40
Total internal water volume	l	2	2	2	3,2	3,2	3,2	3,2	3,2	3,2
Expansion tank volume	l	2	2	2	5	5	5	5	5	5
Expansion tank maximum working pressure	bar	8	8	8	8	8	8	8	8	8
Back-up electric heater capacity	2 kW	3	3	3	3	3	3	4,5	4,5	4,5

1. PHE = plate exchanger

2. Configuration option for size 61-81. Accessory separately supplied only for size 21-41.

General technical data

Sound levels - Standard Mode

SIZE	Sound power level								Sound pressure level	Sound power level
	Octave band (Hz)									
	63	125	250	500	1000	2000	4000	8000	dB(A)	dB(A)
21	55	54	48	46	45	38	37	32	49	61
31	59	56	52	50	50	44	41	37	52	64
41	60	57	54	53	52	47	44	39	55	67
61	61	56	53	51	51	42	36	35	54	68
71	68	62	57	54	52	48	42	40	55	71
81	68	61	57	55	52	47	42	40	56	71
61	62	58	53	51	48	44	38	34	54	68
71	67	62	58	56	53	48	43	39	56	71
81	68	61	59	55	53	48	43	39	56	71

Sound levels refer to units with full load under nominal test conditions.
The sound pressure level refers to a distance of 1 meter from the outer surface of the unit operating in open field.
Noise levels are determined using the tensiometric method (UNI EN ISO 9614-2).

Sound levels - Silenced Mode

SIZE	Sound pressure level	Sound power level
	dB(A)	dB(A)
21	49	61
31	51	63
41	53	65
61	53	67
71	51	67
81	52	67
61	53	67
71	52	67
81	52	68

Sound levels refer to units with maximum test conditions.
For maximum capacity supplied in silent mode, a correction factor of 0,8 shall be used.
The sound pressure level refers to a distance of 1 meter from the outer surface of the unit operating in open field.
Noise levels are determined using the tensiometric method (UNI EN ISO 9614-2)

Data referred to the following conditions in heating:
- internal exchanger water = 30/35°C
- ambient temperature 7/6 °C
Data referred to the following conditions in cooling:
- internal exchanger water = 12/7°C
- ambient temperature 35°C

Sound levels - Super Silenced Mode

SIZE	Sound pressure level	Sound power level
	dB(A)	dB(A)
21	46	59
31	49	60
41	50	62
61	49	63
71	47	63
81	50	65
61	49	63
71	50	65
81	51	66

Sound levels refer to units with maximum test conditions.
For maximum capacity supplied in super silent mode, a correction factor of 0,6 shall be used.
The sound pressure level refers to a distance of 1 meter from the outer surface of the unit operating in open field.
Noise levels are determined using the tensiometric method (UNI EN ISO 9614-2).

Data referred to the following conditions in heating:
- internal exchanger water = 30/35°C
- ambient temperature 7/6 °C
Data referred to the following conditions in cooling:
- internal exchanger water = 12/7°C
- ambient temperature 35°C

Operating range - Cooling

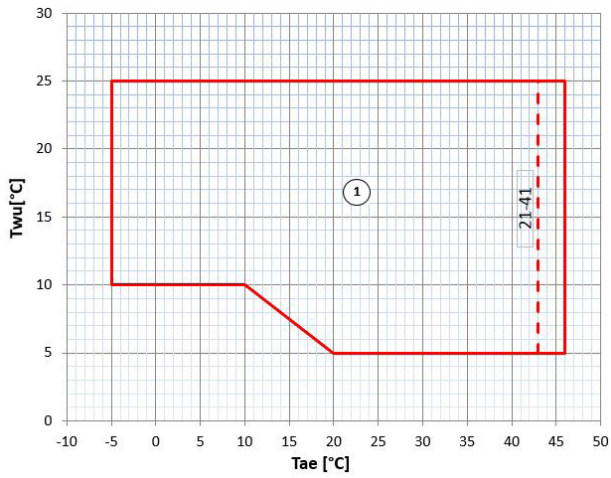

T_{wu} [°C] = Leaving exchanger water temperature
 T_{ae} [°C] = External exchanger inlet air temperature
 1. Normal operating range

Operating range - Heating

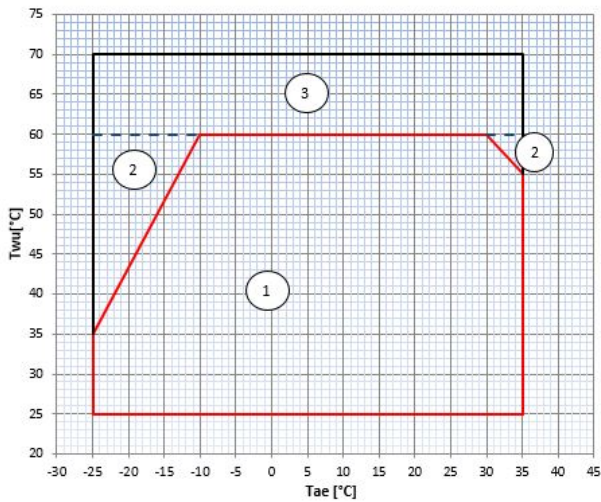

T_{wu} [°C] = Leaving exchanger water temperature
 T_{ae} [°C] = External exchanger inlet air temperature

1. Normal operating range
2. Operating range with only back-up heater
3. Operating range with the Hybrid version of the condensing boiler

⚠ The operating range with only the back-up heater depends on the specific size and is for reference only

Operating range - DWH

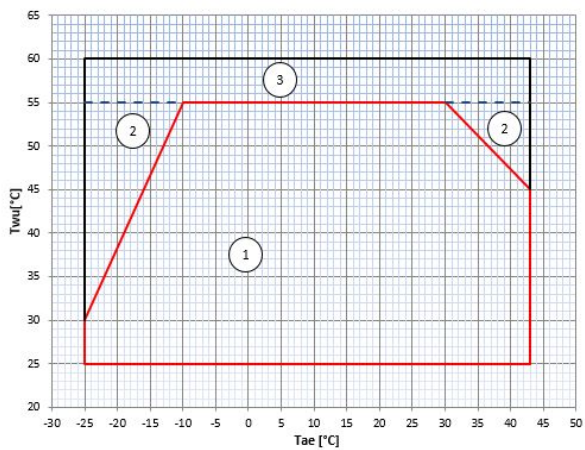

T_{wu} [°C] = Leaving exchanger water temperature
 T_{ae} [°C] = External exchanger inlet air temperature

1. Normal operating range
2. Operating range with only back-up heater
3. Operating range with the Hybrid version of the condensing boiler

Admissible water flow rates

SIZE			21	31	41	61	71	81
Minimum flow-rate	Qmin	[l/s]	0,14	0,20	0,26	0,36	0,42	0,48
Maximum flow-rate	Qmin	[l/s]	0,29	0,40	0,52	0,69	0,80	0,92

Fouling Correction Factors

m ² C/W	Internal exchanger	
	F1	FK1
0,44x10 ⁻⁴	1	1
0,88x10 ⁻⁴	0,96	0,99
1,76x10 ⁻⁴	0,93	0,98

The cooling performance values provided in the tables are based on the external exchanger having clean plates (fouling factor 1). For different fouling factor values, multiply the performance by the coefficients shown in the table.

F1 = Cooling capacity correction factors

FK1 = Compressor power input correction factor

Dimensional drawings

Size 21-41

DAAPB0001_0
DATA/DATE 13/05/2019

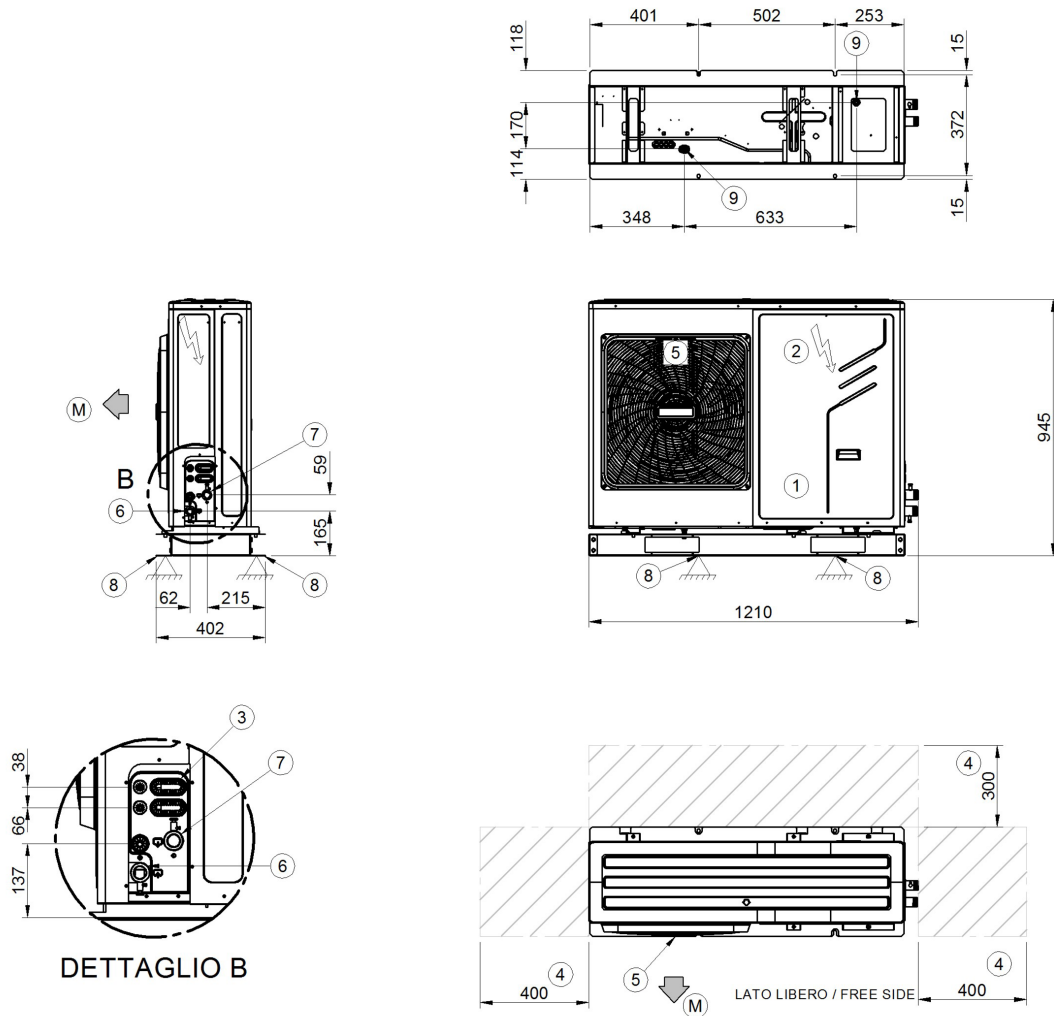

- 1. Compressor compartment
- 2. Electrical panel
- 3. Power input
- 4. Functional spaces
- 5. Electric fan (supply - return)
- 6. Internal exchanger water inlet (OD = 1" GAS M)
- 7. Internal exchanger water outlet (OD = 1" GAS M)
- 8. Support point
- 9. Drain hole
- (M) Air Supply

SIZE		21	31	41
Length	mm	1210	1210	1210
Depth	mm	402	402	402
Height	mm	945	945	945
Operating weight	kg	92	92	92
Shipping weight	kg	111	111	111

The presence of optional accessories may result in a substantial variation of the weights shown in the table.

Size 61-81 Monophase

DAAPB0002_0
DATA/DATE 15/05/2019

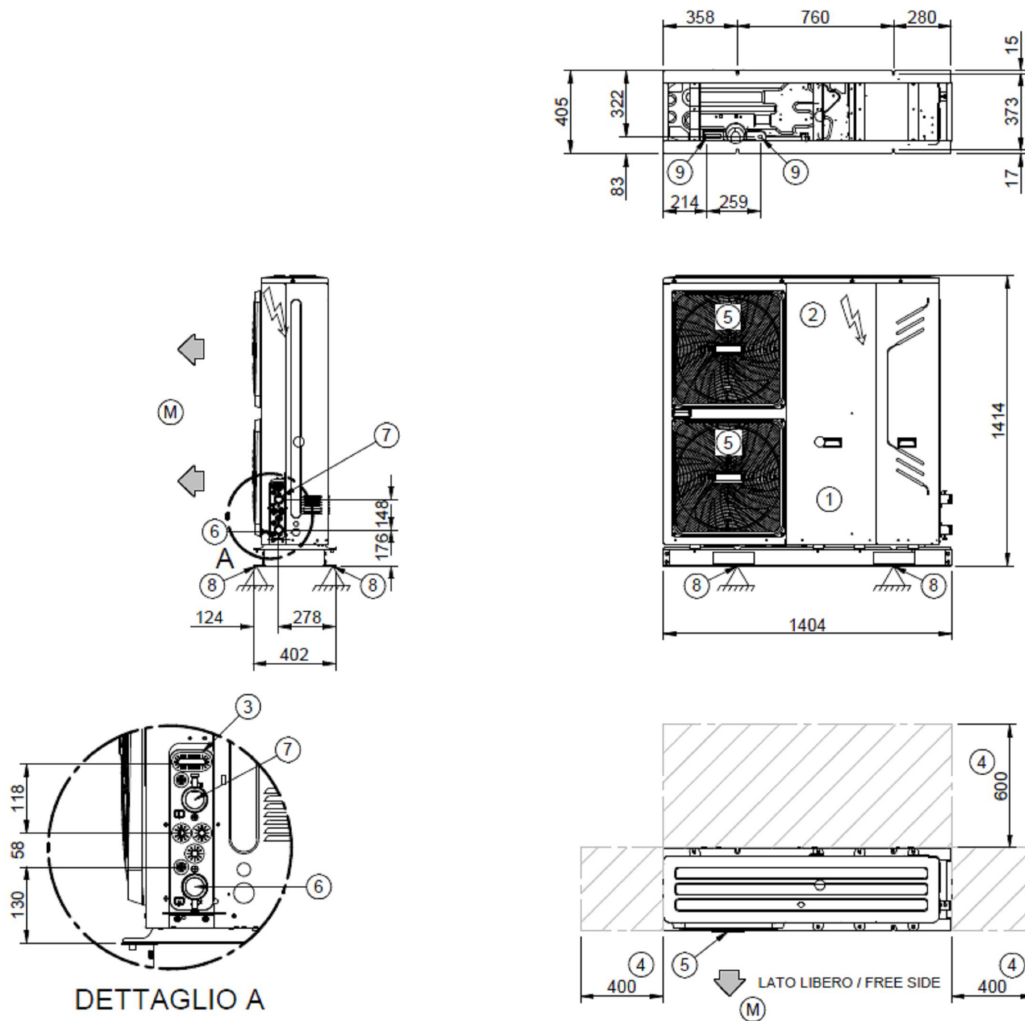

1. Compressor compartment
 2. Electrical panel
 3. Power input
 4. Functional spaces
 5. Electric fan (supply - return)
 6. Internal exchanger water inlet (OD = 1" 1/4 GAS M)
 7. Internal exchanger water outlet (OD = 1" 1/4 GAS M)
 8. Support point
 9. Drain hole
- (M) Air Supply

SIZE		61	71	81
Length	mm	1404	1404	1404
Depth	mm	405	405	405
Height	mm	1414	1414	1414
Operating weight	kg	158	158	158
Shipping weight	kg	178	178	178

The presence of optional accessories may result in a substantial variation of the weights shown in the table.

Dimensional drawings

Size 61-81 Three Phase

DAAPB0002_0
DATA/DATE 15/05/2019

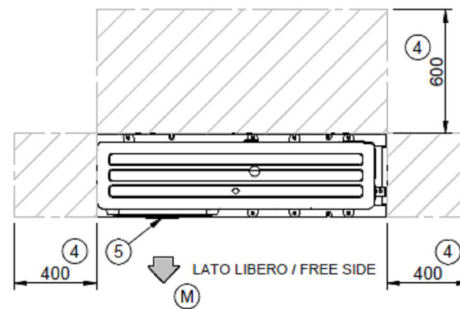
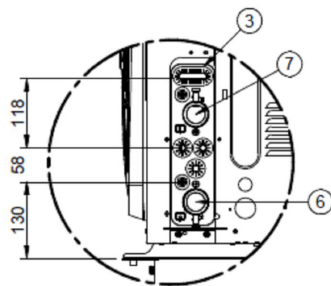
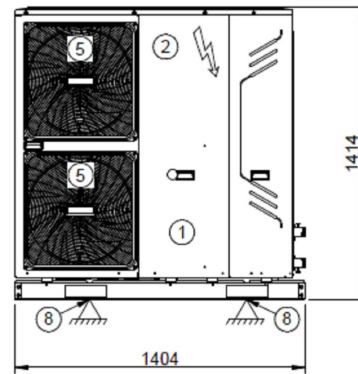
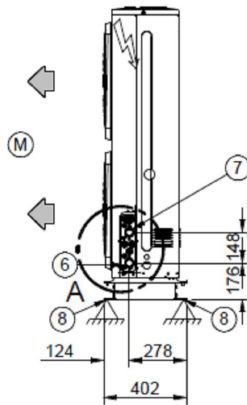
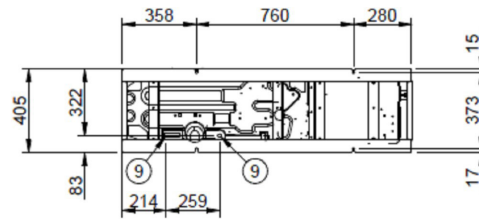

- 1. Compressor compartment
- 2. Electrical panel
- 3. Power input
- 4. Functional spaces
- 5. Electric fan (supply - return)
- 6. Internal exchanger water inlet (OD = 1" 1/4 GAS M)
- 7. Internal exchanger water outlet (OD = 1" 1/4 GAS M)
- 8. Support point
- 9. Drain hole
- (M) Air Supply

SIZE		61	71	81
Length	mm	1404	1404	1404
Depth	mm	405	405	405
Height	mm	1414	1414	1414
Operating weight	kg	172	172	172
Shipping weight	kg	193	193	193

The presence of optional accessories may result in a substantial variation of the weights shown in the table.



DECLARATION OF CONFORMITY UE

DICHIARAZIONE DI CONFORMITÀ EU
KONFORMITÄTSEKTLÄRUNG UE
DECLARATION DE CONFORMITE UE
DECLARACIÓN DE CONFORMIDAD UE

WE DECLARE UNDER OUR SOLE RESPONSIBILITY THAT THE MACHINE

DICHIARIAMO SOTTO LA NOSTRA SOLA RESPONSABILITÀ CHE LA MACCHINA
WIR ERKLÄREN EIGENVERANTWORTLICH, DASS DIE MASCHINE
NOUS DÉCLARONS SOUS NOTRE SEULE RESPONSABILITÉ QUE LA MACHINE
EL FABRICANTE DECLARA BAJO SU EXCLUSIVA RESPONSABILIDAD QUE LA MÁQUINA

CATEGORY **WATER CHILLERS - Heat pump**
CATEGORIA **REFRIGERATORI D'ACQUA - Pompa di calore**
KATEGORIE **KALTWASSERSÄTZE - Wärmepumpe**
CATEGORIE **RÉFRIGÉRATEURS D'EAU - Pompe à chaleur**
CATEGORIA **ENFRIADORAS DE AGUA - Bomba de calor**

TYPE / TIPO / TYP / TYPE / TIPO

MODEL
WSAN-YMi 21
WSAN-YMi 31
WSAN-YMi 41

- **COMPLIES WITH THE FOLLOWING EC DIRECTIVES, INCLUDING THE MOST RECENT AMENDMENTS, AND THE RELEVANT NATIONAL HARMONISATION LEGISLATION CURRENTLY IN FORCE:**
- RISULTA IN CONFORMITÀ CON QUANTO PREVISTO DALLE SEGUENTI DIRETTIVE CE, COMPRESSE LE ULTIME MODIFICHE, E CON LA RELATIVA LEGISLAZIONE NAZIONALE DI RECEPIMENTO:
- DEN IN DEN FOLGENDEN EG-RICHTLINIEN VORGESEHENEN VORSCHRIFTEN, EINSCHLIEßLICH DER LETZTEN ÄNDERUNGEN, SOWIE DEN ANGEWANDTEN LANDESGESETZEN ENTSPRICHT:
- EST CONFORME AUX DIRECTIVES CE SUIVANTES, Y COMPRIS LES DERNIÈRES MODIFICATIONS, ET À LA LÉGISLATION NATIONALE D'ACCUEIL CORRESPONDANTE:
- ES CONFORME A LAS SIGUIENTES DIRECTIVAS CE, INCLUIDAS LAS ÚLTIMAS MODIFICACIONES, Y A LA RELATIVA LEGISLACIÓN NACIONAL DE RECEPCIÓN:
- 2006/42/EC** **machinery directive**
direttiva macchine
Maschinenrichtlinie
directive sur les machines
directiva máquinas
- 2014/30/UE** **electromagnetic compatibility**
compatibilità elettromagnetica
Elektromagnetische Verträglichkeit
compatibilité électromagnétique
compatibilidad electromagnética
- 2009/125/CE** **Ecodesign /Progettazione ecocompatibile / Ecodesign / Éco-conception / Ecodiseño**
- 2011/65/UE** **RoHS**

-Unit manufactured and tested according to the followings Standards:	EN 60335-1 :2012/A13 :2017 EN 60335-2-40 :2003/A13 :2012
-Unità costruita e collaudata in conformità alle seguenti Normative:	EN 62233 :2008 EN 55014-1 :2017 EN 55014-2 :2015 EN 61000-3-2 :2014
-Unité construite et testée en conformité avec les Réglementations suivantes	EN 61000-3-3 :2013 EN 61000-3-11 :2000 EN 61000-3-12 :2011
-Unidad construida y probada de acuerdo con las siguientes Normativas	EN 62321-1 :2013 EN 62321-2 :2014 EN 62321-3-1 :2014
-Gebauts und geprüftes Gerät nach folgenden Normen	EN 62321-4 :2014 EN 62321-5 :2014 EN 62321-6 :2015
	EN 62321-7-1 :2015 EN 62321-7-2 :2017 EN 62321-8 :2017

-Responsible to constitute the technical file is the company n°.00708410253 and registered at the Chamber of Commerce of Belluno Italy
-Responsabile a costituire il fascicolo tecnico è la società n° 00708410253 registrata presso la Camera di Commercio di Belluno Italia
-Verantwortliche für die technischen Unterlagen zusammenstellen n°.00708410253 ist das Unternehmen bei der Handelskammer von Belluno Italien registriert
-Responsable pour compiler le dossier technique est la société n°00708410253 enregistrée à la Chambre de Commerce de Belluno en Italie
-Encargado de elaborar el expediente técnico es la empresa N ° 00708410253 registrada en la Cámara de Comercio de Belluno Italia

NAME / NOME / VORNAME / PRÉNOM / NOMBRE
SURNAME / COGNOME / ZUNAME / NOM / APELLIDOS
COMPANY POSITION / POSIZIONE / BETRIEBSPOSITION / FONCTION / CARGO
FELTRE, 28/01/2019
STEFANO BELLO
LEGALE RAPPRESENTANTE

Page intentionally left blank

Page intentionally left blank

Page intentionally left blank

FOR OVER 30 YEARS, WE HAVE BEEN
OFFERING SOLUTIONS TO ENSURE
SUSTAINABLE COMFORT AND THE
WELL-BEING OF PEOPLE AND THE
ENVIRONMENT

www.clivet.com



sales and assistance



CLIVET SPA

Via Camp Lonc 25, Z.I. Villapaiera

32032 Feltre (BL) - Italy

Tel. +39 0439 3131 - Fax +39 0439 313300

info@clivet.it

A Group Company of

